



KeDrive for Motion

All-in-one
control system



KEBA[®]

Automation by innovation.

KeDrive for Motion

All-in-one control system

KeDrive for Motion is a compact, space-saving, all-in-one system as an economical solution for a wide range of control and drive tasks.

It can be used to easily, safely and efficiently automate even complex systems. If the automation system has a modular structure, the control module can also be used alone – just like a classic control.

Other system components such as drives, visualizations, I/Os etc. can be connected with ease. In addition, the KeDrive D3 drive modules can be used alone as decentral drive solution in an already existing control system.





Contents

Page

KeDrive for Motion

All-in-one control system 4

KeDrive D3-DU

Motion control 6

KeDrive D3-DU 3x5

Safety controller 10

KeDrive D3-DU

Motion control accessories 14

KeDrive D3-DP

Supply unit 16

Supply unit accessories 20

KeDrive D3-DA

Axis controllers 22

Axis controller accessories 28

KeDrive D3-SMM

Safety encoder box 30

Encoder box accessories 34

KeDrive D3

Motor cables 36

Selection aid 38

KeDrive D3

Hiperface configuration 40

Hiperface DSL configuration 42

KeDrive for Motion

All-in-one control system

Product properties

- Compact, full form factor
- Modular, scalable system set-up
- Integrated, cross-axis safety controller
- 1-, 2- and 3-axis drive modules
- 300% overload capacity



Short description

KeDrive for Motion is a compact drive and control system with integrated safety controller. As a modular, all-in-one system, it can be configured and programmed using a modern suite of tools in a user-friendly and time-saving manner. State-of-the-art technology, highest economic efficiency and maximum availability are typical features of this innovative automation solution.

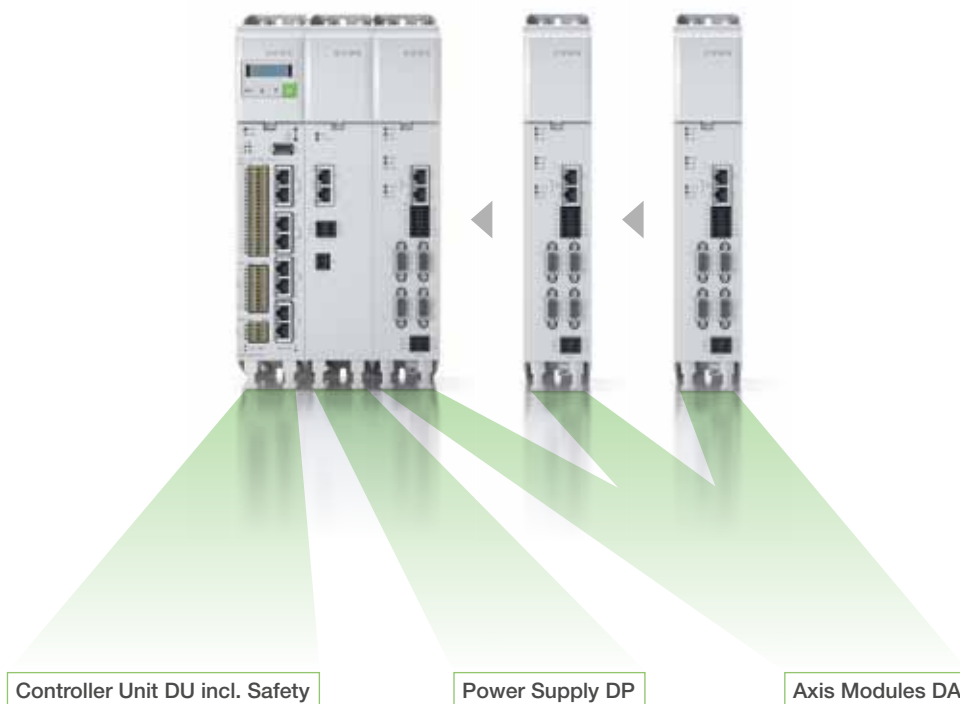

KeDrive D3 Modules

Control
DU + Safety



Control and Safety

24V link, EtherCAT

Power Supply
DP



10...22 kW

DC link, 24V link, EtherCAT

Axis Modules
DA + SMM



1.5...32 A

Motors

Synchron Motors
up to 345 Nm



Linear Motors*
up to 5,000 N



Torque Motors*
up to 5,000 Nm



Gear Boxes*
up to 5,000 Nm



* on request

Accessories

Engineering
KeStudio



EMC
Line filter



Energy
Brake resistors
DC Link capacitors



Connection
Motor cables
Encoder cables
Bus cables



KeDrive for Motion can be used to generate a wide range of automation solutions. The openness of the interfaces facilitates easy integration in existing architectures.

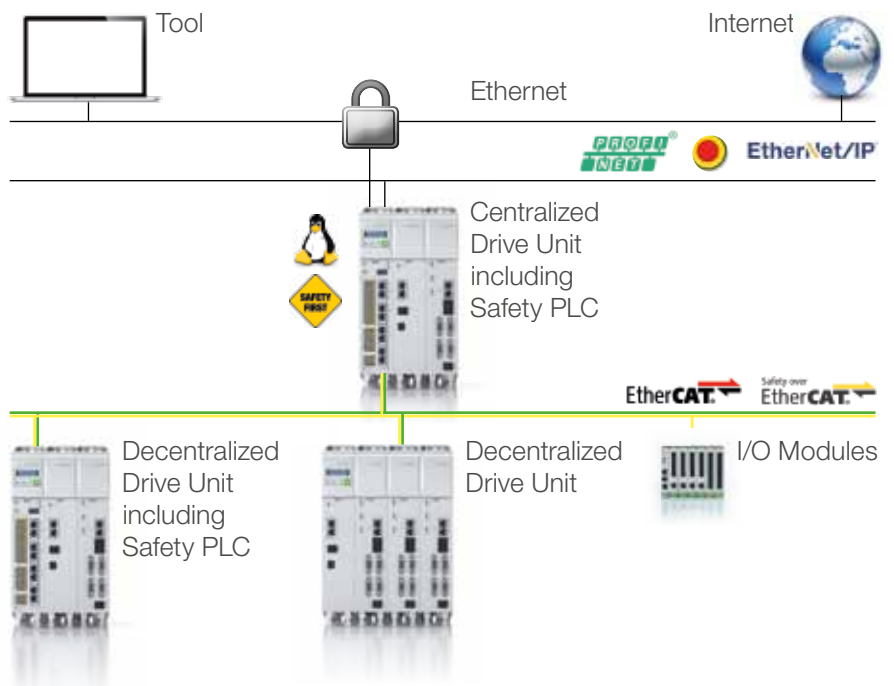

KeDrive D3-DU

Motion control

Product properties

- High-performance and scalable
- Maximum flexibility through free choice of field buses
- Optionally integrated, cross-axis safety controller including safe I/Os
- High-speed EtherCAT



Short description

The D3-DU control solution for PLC, motion and robotics is high-performance with maximum flexibility. Numerous CPU versions - from the Intel Atom 1.3 GHz to the Intel Core i3 2x 2.1 GHz - facilitate application-optimized computing power, thereby enabling drive control, visualization, feedback control, image processing and standardized PLCs to run economically on a single control system.

The control module is optionally available with a directly integrated safety controller including safety I/Os. A small display supports with quick configuration and diagnosis of the control, safety controller and drives.

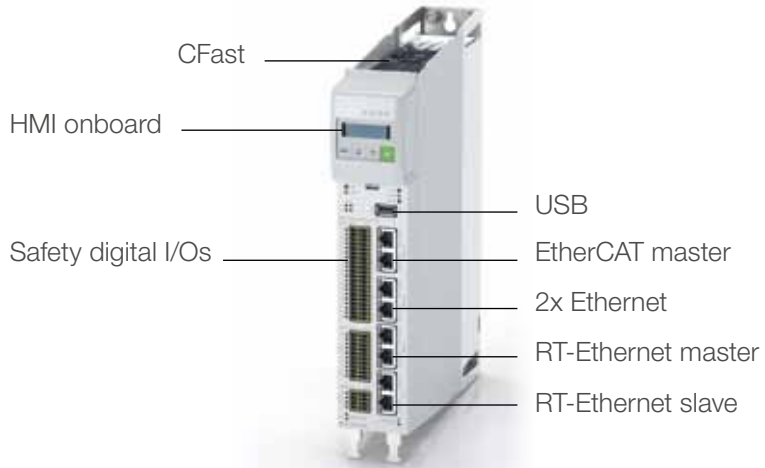

Type code

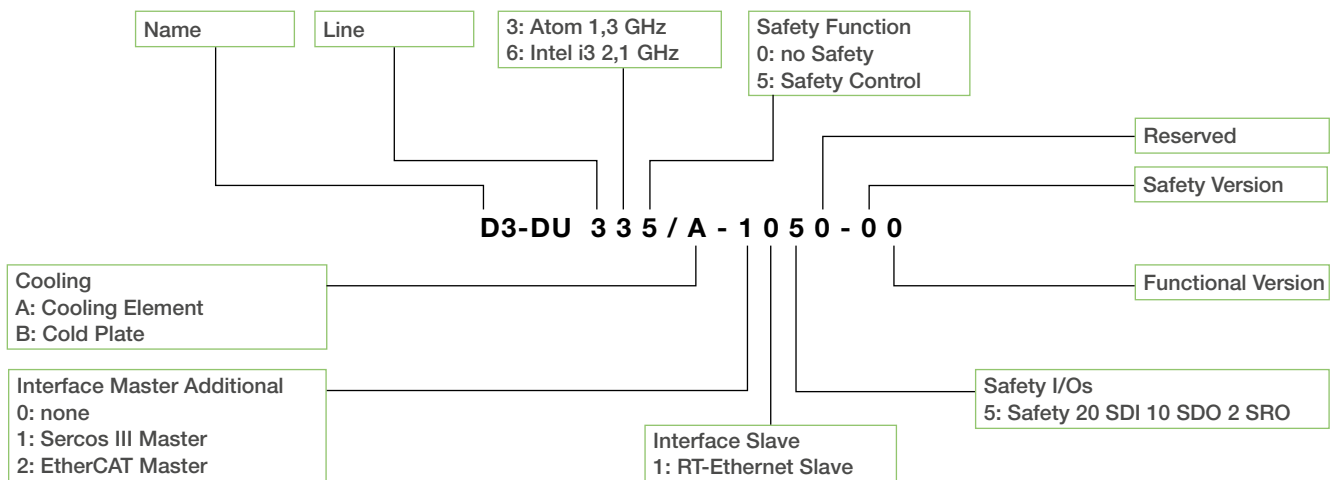

KeDrive D3-DU

Motion control

CPU board	D3-DU 33x/x	D3-DU 36x/x
Processor	Intel Atom 1.3 GHz	Intel Core i3 2x 2.1 GHz
Memory	1 GB DDR2-SDRAM	1 GB DDR3-SDRAM
Buffered SRAM	1 MB (100 kB for retain data, 900 kB for files)	

Interfaces		
Graphic interface cable length	DVI up to 20 m	
Ethernet	10/100/1000 Mbit	
EtherCAT	2 connections	
Master field bus	EtherCAT	
		Additional optional interface EtherCAT or Sercos
Slave field bus	Sercos, EtherCAT, PROFINET or Ethernet/IP configurable	
USB	3x USB 2.0	
CFast	Type 1	

Dimensions, weight	D3-DU 33x/x	D3-DU 36x/x
Dimensions HxWxD	310 x 55 x 240 mm	
Weight	2,860 g	2,700 g

Environmental conditions	
Operating temperature	+5 °C to +55 °C
Storage temperature	-40 °C to +70 °C
Relative air humidity	10% to 95% (non-condensing)
Vibration resistance	Acc. to EN 61131-2

General	D3-DU 33x/x	D3-DU 36x/x
Supply voltage	24 V DC, nominal voltage tolerance: 19.2 V to 30 V, acc. to EN 61131-2	
Max. input current	10 A	
Overvoltage category	III (for 230V SRO)	
Protection class	I acc. to EN 61131-2	
Max. total power consumption	25 W	60 W
Additional power consumption Safety technology without I/Os	Own power consumption: 3.2 W Under load: 108 W	
Protection rating	IP20	
Certification	CE, UL and TÜV in case of integrated safety control	

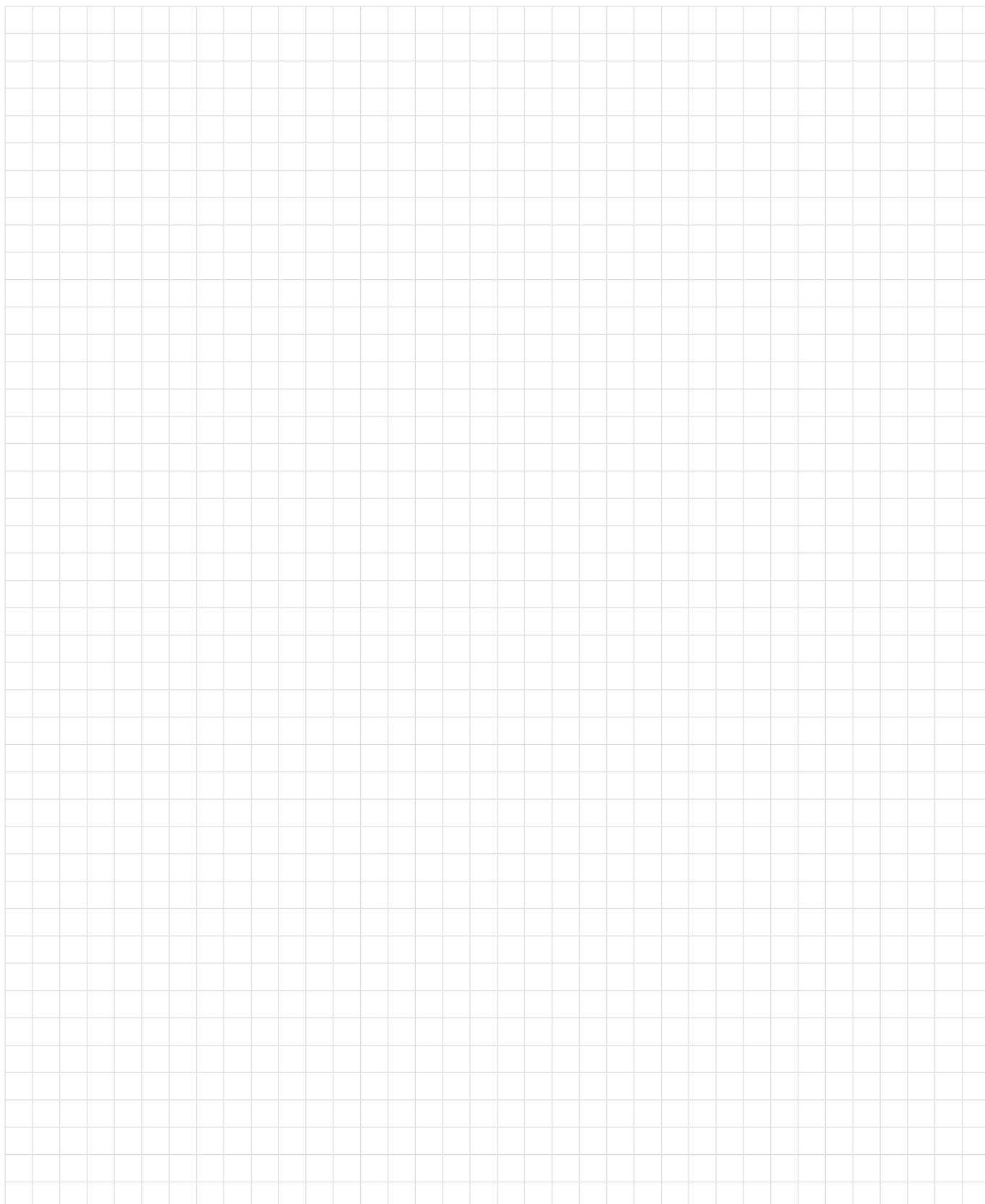

KeDrive D3-DU 3x5

Safety controller

Product properties

- Best performance for I/O, single-axis and robot safety
- Fast response times
- Highly integrated in the functional control
- Expandability through safe bus protocols



Short description

The safety controller is a safety option integrated in the KeDrive D3-DU. The integrated design means that the requirements with regard to compactness in the switching cabinet are particularly well met. This safety controller combines safety logic and drive monitoring in one device. Additional safety functions in the drive are therefore no longer necessary, with the exception of STO (Safe Torque Off).

Simple safety tasks through to enhanced safety-oriented robotics solutions can be implemented easily and quickly. The safety controller already has 30 fail-safe inputs and outputs and enables expansion via EtherCAT.

A graphical programming tool with numerous pre-defined functions makes it simple to configure safety sensors and actuators and even entire robots. Inputs and outputs can easily be linked to the safety logic by means of "drag & drop."

Digital safety inputs

Number of inputs	20
Input type	Type 1 (acc. to EN 61131-2)
Voltage range for "1"	$15\text{ V} \leq U_H \leq 30\text{ V}$
Voltage range for "0"	$-3\text{ V} \leq U_L \leq 5\text{ V}$
Status display	Green LED
OSSD-capable	yes
Number of test outputs for crossfault detection	4

Digital safety outputs

Number of digital outputs	10
Nominal voltage	24 V DC
Nominal current of digital outputs	8 x 0.5 A; 2 x 2 A
Number of relay outputs	2
Max. voltage for relay outputs	230 V potential-free, N.O. contact
Nominal current for relay outputs	4 A
Status display	Orange LED
Overload protection / short-circuit proof	yes



General

Number of communication partners	8
Safety protocols	FSoE, PROFIsafe
Function blocks	500
Current consumption without I/Os	150 mA
Cycle time - safety controller	16 ms
Cycle time - FSoE	min. 2 ms
Certification	CE, TÜV, UL
Safety class for I/Os	Up to PLe Category 4 acc. to EN ISO 13849-1 Up to SIL3 acc. to EN 61508
Safety class for axis safety	Up to PLd Category 3 acc. to EN ISO 13849-1 Up to SIL2 acc. to EN 61508









KeDrive D3-DU 3x5

Safety control





Safe logic functions		
	Enabling button	1- or 2-channel input signals, logical and optional time-based comparison for 2-channel inputs, optional confirmation request after start/actuation
	Emergency stop	Logical and optional time-based comparison of the two inputs, optional confirmation request after unlocking
	Door locking	2- or 3-channel input signals, logical and optional time-based comparison of the input signals, optional confirmation request after start/actuation
	2-hand button	2- or 4-channel input signals, monitoring of the input signals acc. to EN 574. Certified function for 2-hand operation
	Limit switch	1- or 2-channel input signals, logical and optional time-based comparison of the two inputs
	Light curtain	1- or 2-channel input signals, logical and optional time-based comparison of the two inputs, optional confirmation request after start/triggering and monitored start
	Operating mode selector switch	2- or 3-channel input signals, logical monitoring of the input signals
	Scanner	1- or 2-channel input signals, logical and optional time-based comparison of the two inputs, optional confirmation request after start/triggering and monitored start
	Safe digital output	Switches a safe digital output to trigger safety functions on other devices, e.g., STO (Safe Torque Off) or SBC (Safe Brake Control), on the axis controllers or encoder box.
Logical operations		Standard modules such as AND, OR, XOR, NOT, RS-Flip-Flop, Timer, EDM (External Device Monitoring) etc.

Safe interfaces		
	PROFIsafe	Functional safety via PROFINET as slave
	FSOE	Safety over EtherCAT as master and slave

Safe single-axis functions

	SSX Safe Stop 1/2	Monitoring of the braking ramp and shutdown of the motor after standstill (SS1) or monitoring of the braking ramp and SOS after standstill (SS2) Corresponds to stop category 1 or 2 acc. to EN 60204-1
	SOS Safe Operation Stop	Standstill monitoring with active motor
	SLS Safely-Limited Speed	Monitoring of a speed limit value
	SLP Safely-Limited Position	Monitoring for exceeding a position limit value
	SEL Safe Emergency Limit	Safe monitoring of the minimum and maximum position or of the permitted position range; optional monitoring of the speed/position limit curve for minimizing the worst-case travel path
	SLI Safely-Limited Increment	Adherence to a specified increment size is monitored during movement
	SDI Safe Direction	Monitoring of the direction of movement
	SCA Safe CAM	A safe output signal is generated while the motor position is in a specific area
	SRX Safe Referencing	Safe calculation and storage of the encoder offset

Safe robot functions

	Safe Cartesian Zone Monitoring	Safe Cartesian position monitoring of arbitrary points on the robot
	Safe Orientation Monitoring	Safe monitoring of the tool orientation
	Safe Changing Unit (Safe Tool)	Safe detection of tool and tool changes
	Safe Cartesian Robot Transformation	Safe robot transformation
	Safely-Limited Cartesian Speed	Safe speed monitoring of arbitrary points on the robot

KeDrive D3-DU

Motion control accessories

Memory card D3-XC 340/A

Data carrier for saving configurations and application and device data

- Alternative to expensive SATA SSD
- Power fail protection



Suitable for D3-DU 33x/x, D3-DU 36x/x

Type	CFast
Memory capacity	2 GB

Dimensions, weight

Dimensions HxWxD	36.4 x 42.8 x 3.3 mm
Weight	9.5 g

Connector set D3-XT 215/A

For connection of the I/Os on the safety option

- Spring-clamp terminals
- Wiring of safe I/Os
- Protected against incorrect connection



Suitable for D3-DU 3xx/x-xx5x

Type	Spring-clamp terminals
------	------------------------

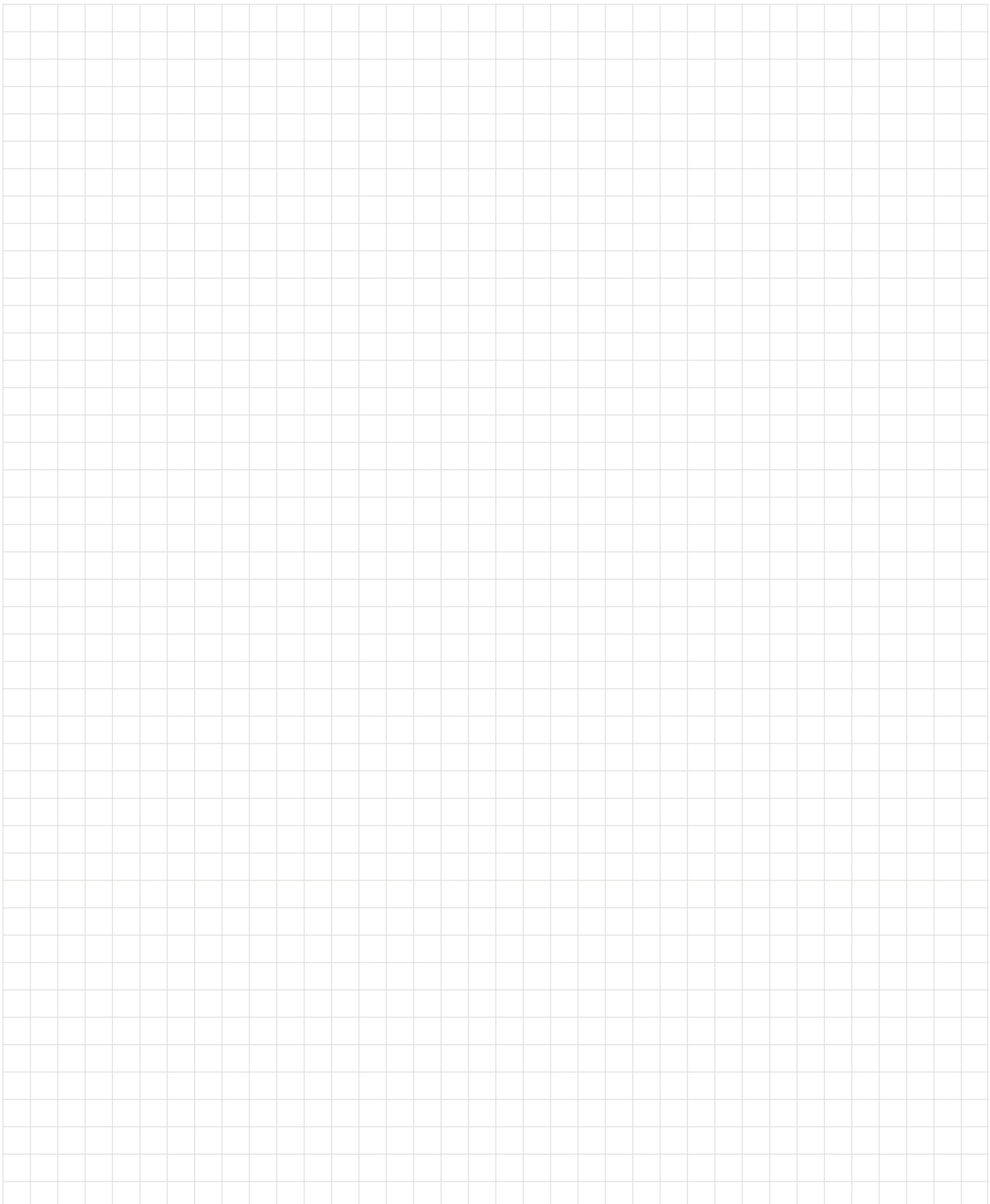

KeDrive D3-DP

Supply unit

Product properties

- Large mains voltage range
- High performance
- High availability
- Power-failure-proof 24 V control voltage integrated



Short description

The supply unit offers a central mains supply for the entire axis system and ensures an easy as well as time- and cost-optimized installation.

By supplying the axes via a DC link, an optimum energy exchange takes place between the axes. The braking energy produced during regenerative operation is dissipated via a common, central brake resistor.

In addition to the power supply, 24 V of control voltage is also available for drives, control, safety controller and peripheral devices. In the event of mains failure, the required energy is taken from the DC link to safely bring the drives to a standstill.



Type code

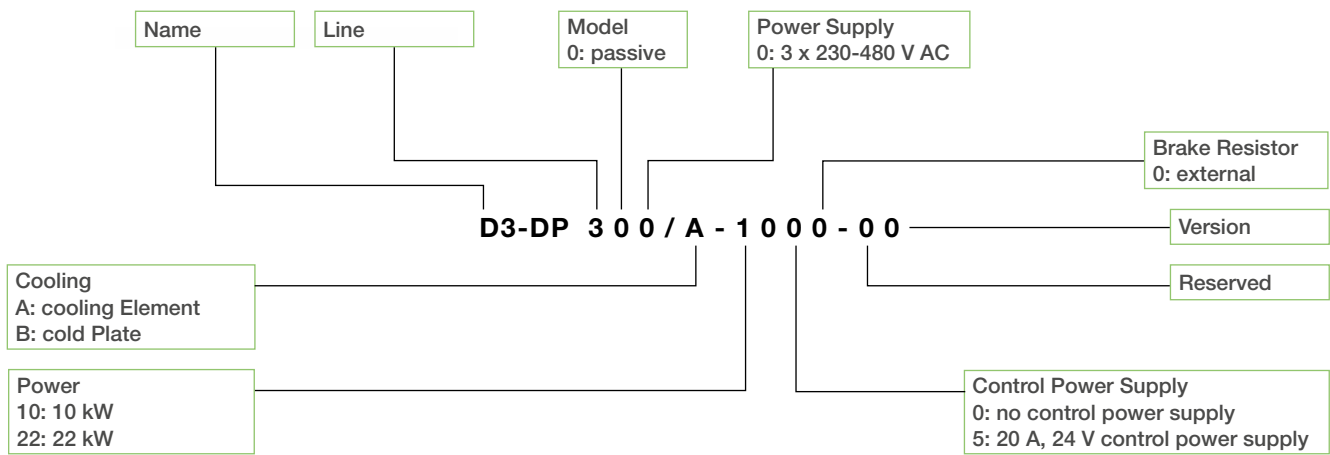

KeDrive D3-DP

Supply unit

24 V supply		D3-DP 3xx/x-xx4x , D3-DP 3xx/x-xx5x
Rated output current	20 A	
Maximum current	40 A	
Fuse	Safety fuse 2 x 6 A (gG)	

Mains supply	D3-DP 3xx/x-10xx	D3-DP 3xx/x-22xx
Mains voltage	3 x 230 V AC – 3 x 480 V AC	
Continuous input mains current	3 x 25 A, dependent on mains impedance	3 x 50 A, dependent on mains impedance
Continuous power	Typically 14 kVA	Typically 28 kVA
Power loss of rectifier	~ 50 W	110 W
Fuse	Safety fuse 3 x 35 A (gG)	Safety fuse 3 x 63 A (gG)

DC link	D3-DP 3xx/x-10xx	D3-DP 3xx/x-22xx
Mains voltage	3 x 230 V AC – 3 x 480 V AC	
DC link capacitance	330 µF	840 µF
Max. DC link capacitance	2000 µF (330 + 1670)	4000 µF (840 + 3160)
DC link continuous power	10 kW	22 kW
DC link maximum power 2 x PN for 1 s	20 kW	44 kW
DC link continuous current	18 A DC	35 A DC
DC link maximum current 2 x IN for 1 s	36 A DC	70 A DC
Power loss	85 W	130 W
Fuse	Safety fuse 3 x 35 A (gG)	Safety fuse 3 x 63 A (gG)

Brake chopper	D3-DP 3xx/x-10xx	D3-DP 3xx/x-22xx
Continuous braking power	3 kW	6 kW
Max. braking power for 0.5 s	16 kW	32 kW
Min. ohmic resistance of the connected brake resistor	33 Ohm	15 Ohm
Max. ohmic resistance of the connected brake resistor	90 Ohm	90 Ohm

Dimensions, weight		
	D3-DP 3xx/x-10xx	D3-DP 3xx/x-22xx
Dimensions (with heat sink) HxWxD	310 x 55 x 241 mm	310 x 110 x 241 mm
Dimensions (with cold plate) HxWxD	310 x 55 x 188.5 mm	310 x 110 x 188.5 mm
Weight with heat sink	2.65 kg	5.1 kg
Weight with cold plate	2.2 kg	4.2 kg

Environmental conditions	
Operating temperature	-10 °C to +40 °C (up to 50 °C derating 5% per °C)
Storage temperature	-25 °C to +55 °C
Relative air humidity	5% to 85% (non-condensing)
Vibration resistance / shock resistance	Acc. to EN 61800-1

General	
Protection rating	IP20 with exception of the terminals (IP00)
Certification	CE, UL
Installation altitude	Up to 1000 m above sea level, above this with derating (1% per 100 m, max. 2000 m above sea level)

KeDrive D3-DP

Supply unit accessories

Connector set D3-XT 22x/A

Connector set for connecting the I/Os, supply, and brake resistor on the supply unit



	D3-XT 220/A	D3-XT 221/A
Suitable for	D3-DP 3xx/x-10xx	D3-DP 3xx/x-22xx
Type	Spring-clamp terminals	Spring-clamp terminals

Brake resistor VHPR; RXLG

For connecting to the supply unit for dissipating braking energy during regenerative operation.

- High-voltage resistant
- High availability



Suitable for D3-DP 3xx/x	
Surface temperature	> 250 °C
Voltage	Max. 970 V DC
Connection	1 m PTFE wire
Protection rating	IP54

	VHPR 300 V 90R J	VHPR 500 V 40R J	RXLG-S1 1000W 40R J
Continuous brake power at 3x400 V supply voltage	260 W	300 W	950 W
Maximum brake power at 3x400 V supply voltage	4.4 kW	10.0 kW	10.0 kW
Certification	CE, UL	CE, UL	CE
Dimensions LxWxH	217 x 31 x 60 mm	337 x 31 x 60 mm	400 x 50 x 108 mm

Line filter D3-XF xxx/x

For compliance with the EMC limit values and for suppressing leakage currents that are caused by line capacitances

- High-voltage resistant
- High availability



	D3-XF 025/A-0612-00	D3-XF 025/A-1260-00	D3-XF 053/A-0612-00	D3-XF 053/A-1260-00
Suitable for	D3-DP 300/x-10xx	D3-DP 300/x-10xx	D3-DP 300/x-22xx	D3-DP 300/x-22xx
Max. mains voltage	3 x 400 V AC	3 x 400 V AC	3 x 400 V AC	3 x 400 V AC
Number of phases	3	3	3	3
Max. number of axes	6	12	6	12
Max. total cable length	120 m	600 m	120 m	600 m
Continuous current	25 A	25 A	53 A	53 A
Protection rating	IP20	IP20	IP20	IP20
Certification	CE, UL	CE, UL	CE	CE, UL
Power loss	4.7 W	9.8 W	13.3 W	18.7 W
Dimensions HxWxD	270 x 62 x 115 mm	291 x 54.5 x 221 mm	270 x 62 x 115 mm	291 x 54.5 x 221 mm
Weight	3.4 kg	5.7 kg	2.3 kg	6.3 kg

KeDrive D3-DA

Axis controller

Product properties

- High overload capability
- Flexible range of application
- Up to 3 axes in one device
- Multi-encoder interfaces



Short description

The KeDrive DA axis controller, with its various design versions, offers optimum flexibility and economic efficiency. Thanks to drive versions with 1 to 3 axes in one module, a modular and very compact design can be realized. The KeDrive D3-DA axis controller operates all common synchronous and asynchronous motors and direct drives. With the multi-encoder interface, a wide range of encoder types can be connected to one interface.

The most fundamental, drive-integrated safety function STO (Safe Torque Off) prevents an unwanted startup of the motor according to EN 60204-1; it safely renders the drive torque-free. This function in combination with the optional SBC safety function (Safe Brake Control) is integrated as standard in the axis controllers.

The inputs, which are likewise integrated as standard, can be configured for detecting end position switches or reference switches. They can also be freely occupied with any digital sensors and evaluated in the control application.



Type code

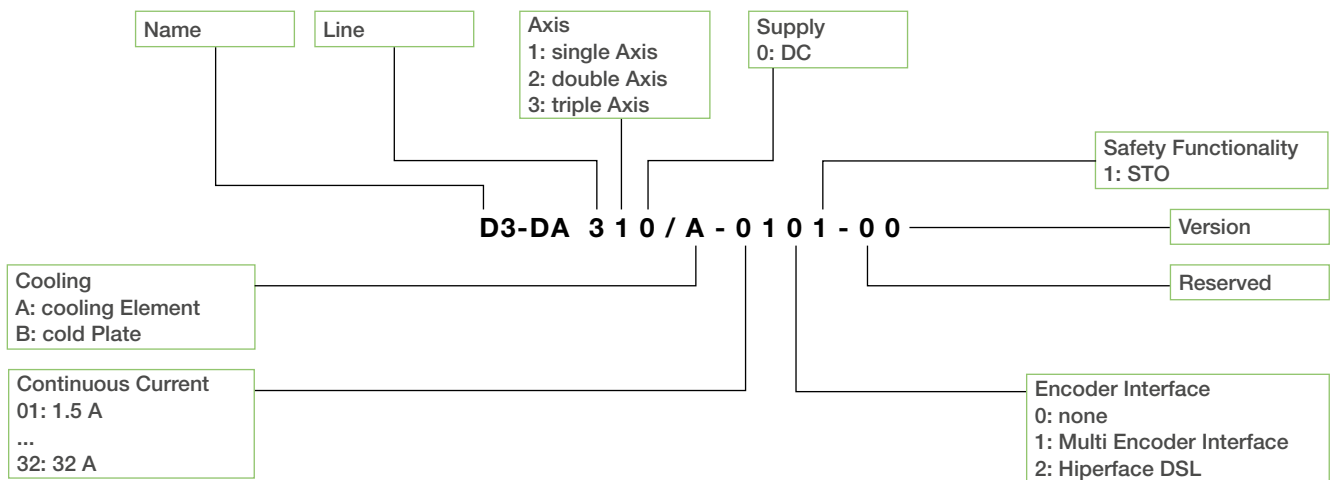

KeDrive D3-DA

Axis controllers

Functions	
Axis correction	With this function, it is easy to compensate for any play present in the mechanics.
Digital filter	To filter any present noise components or to dampen resonant frequencies, various filters are available: e.g. PT1 – PT4 filter, notch filter, band elimination filter, user-defined filter
Detent torque compensation	The function can be used to compensate for rotor-position-dependent detent torques
Friction torque compensation	Model-based compensation of system friction
Motor identification	Automatic detection and identification of motors and determination of the feedback control settings
Autotuning	With the Autotuning function, the commutation offset can be detected and the load moment of inertia determined. From this, the feedback control parameters for position, speed and torque control can be determined.
Analysis functions	For the analysis of system step response, transfer functions, FFT, test signal generator
High-speed communication	Communication between drive and control can be performed with a minimal cycle time of 125 µs.
Motor simulation	The motor is operated in the simulation. The real motor is not necessary for this function.
Power fail	A power failure is detected and communicated to the control.
Absolute-encoder simulation	Single-turn encoder can be used as multi-turn encoder.
Encoder correction	Compensation functions for compensating for encoder errors and offsets
Gain reduction	For very dynamically set feedback controls, the feedback control settings can be reduced for small speeds and the tendency to oscillate avoided.

Functional data	
Multi-encoder interface	Resolver, SinCos, SSI, Hiperface, EnDat 2.1/2.2
Additional encoder interface	SinCos, TTL
Field bus	EtherCAT CoE
Digital inputs	9
Safety technology (SIL3, Ple, Cat 4)	STO
Safe digital inputs	4

Power data for single-axis controller	D3-DA 310/x-01xx	D3-DA 310/x-03xx	D3-DA 310/x-06xx	D3-DA 310/x-12xx	D3-DA 310/x-18xx	D3-DA 310/x-24xx	D3-DA 310/x-32xx
Continuous current	1.5 A	3 A	6 A	12 A	18 A	24 A	32 A
Maximum current for 10 s (* for 2 s)	3 A	6 A	12 A	24 A	36 A*	48 A	64 A*
Maximum current for 0.5 s	4.5 A	9 A	18 A	36 A	48 A	72 A	80 A
DC link capacitance	165 µF	165 µF	165 µF	405 µF	225 µF	675 µF	675 µF
DC resistance in DC link (DC+ after DC-)	146 kOhm	146 kOhm	146 kOhm	146 kOhm	350 kOhm	146 kOhm	146 kOhm
Power output - brake driver	48 W	48 W	48 W	48 W	48 W	48 W	48 W

Power data for double-axis controller	D3-DA 320/x-01xx	D3-DA 320/x-03xx	D3-DA 320/x-06xx	D3-DA 320/x-12xx	D3-DA 320/x-16xx
Continuous current	1.5 A	3 A	6 A	12 A	16 A
Maximum current for 10 s (* for 3 s)	3 A	6 A	12 A	24 A	32 A*
Maximum current for 0.5 s	4.5 A	9 A	18 A	36 A	40 A
DC link capacitance	165 µF	165 µF	165 µF	405 µF	405 µF
DC resistance in DC link (DC+ after DC-)	146 kOhm	146 kOhm	146 kOhm	146 kOhm	146 kOhm
Power output - brake driver	2 x 48 W	2 x 48 W	2 x 48 W	2 x 48 W	2 x 48 W

Power data for triple-axis controller	D3-DA 330/x-01xx	D3-DA 330/x-03xx	D3-DA 330/x-06xx	D3-DA 330/x-12xx
Continuous current	1.5 A	3 A	6 A	12 A
Maximum current for 10 s	3 A	6 A	12 A	24 A
Maximum current for 0.5 s	4.5 A	9 A	18 A	36 A
DC link capacitance	165 µF	165 µF	165 µF	405 µF
DC resistance in DC link (DC+ after DC-)	146 kOhm	146 kOhm	146 kOhm	146 kOhm
Power output - brake driver	3 x 48 W	3 x 48 W	3 x 48 W	3 x 48 W

Dimensions and weight of single-axis controller	D3-DA 310/x- 01xx	D3-DA 310/x- 03xx	D3-DA 310/x- 06xx	D3-DA 310/x- 12xx	D3-DA 310/x- 18xx	D3-DA 310/x- 24xx	D3-DA 310/x- 32xx
Dimensions HxWxD	310 x 55 x 240 mm				310 x 110 x 240 mm		
Weight incl. heat sink	~2.65 kg				~5.1 kg		
Weight with cold plate	~2.2 kg				~4.2 kg		

Dimensions and weight of double-axis controller	D3-DA 320/x-01xx	D3-DA 320/x-03xx	D3-DA 320/x-06xx	D3-DA 320/x-12xx	D3-DA 320/x-16xx
Dimensions HxWxD	310 x 55 x 240 mm			310 x 110 x 240 mm	
Weight incl. heat sink	~2.65 kg			~5.1 kg	
Weight with cold plate	~2.2 kg			~4.2 kg	

Dimensions and weight of triple-axis controller	D3-DA 330/x-01xx	D3-DA 330/x-03xx	D3-DA 330/x-06xx	D3-DA 330/x-12xx
Dimensions HxWxD	310 x 55 x 240 mm			310 x 110 x 240 mm
Weight incl. heat sink	~2.65 kg			~5.1 kg
Weight with cold plate	~2.2 kg			~4.2 kg

KeDrive D3-DA

Axis controllers

Environmental conditions

Operating temperature	-10 °C to +40 °C (up to 50 °C derating 5% per °C)
Storage temperature	-25 °C to +55 °C
Relative air humidity	5% to 85% (non-condensing)
Vibration resistance / shock resistance	Acc. to EN 61131-2

General

Protection rating	IP20 with exception of the terminals (IP00)
Certification	CE, UL
Installation altitude	Up to 1000 m above sea level, above this with derating (1 % per 100 m, max. 2000 m above sea level)

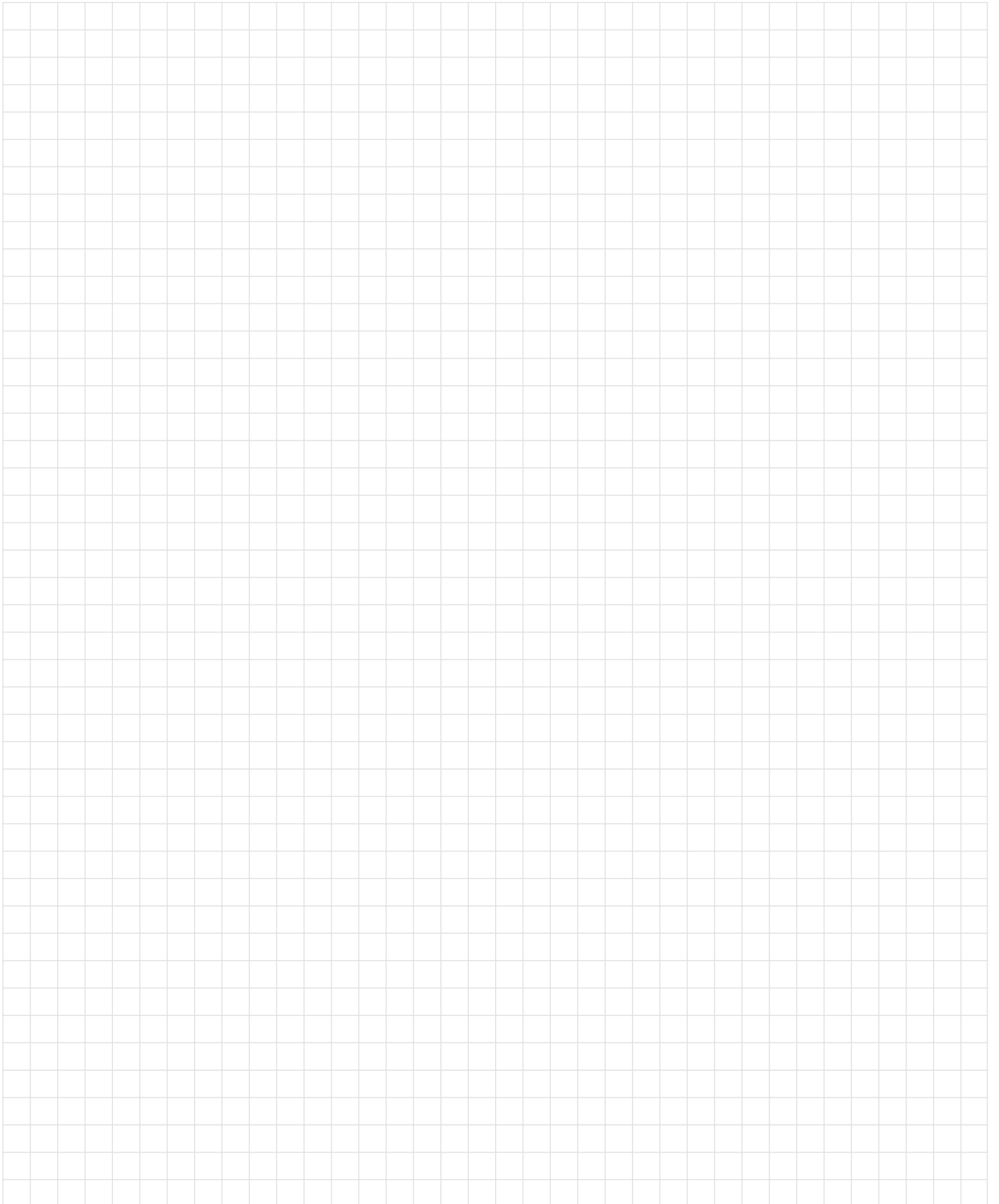

KeDrive D3-DA

Axis controller accessories

Connector set D3-XT 230/A

Connector set for connecting the I/Os on the axis controllers.

- Spring-clamp terminals
- Wiring of onboard I/Os



Suitable for D3-DA 3xx/x

Type	Spring-clamp terminals
------	------------------------

Connector set D3-XT 231/A

Optional connector set for connecting a motor cable on the axis controller. When using KEBA cables XW Pxx-xxx and XW Hxx-xxx, these plugs are already premounted.

- Spring-clamp terminals
- Connection of motor cables



Suitable for D3-DA 3xx/x

Type	Spring-clamp terminals
------	------------------------

EtherCAT cable

EtherCAT cable for communication between D3-DU, D3-DP and D3-DA is already included in delivery.

- Cat 5

Cable for additional D3-DP modules XW 021-xxx

Optional EtherCAT cable for adding one more D3-DP 300/x module or another EtherCAT device to an axis system.

- Cat 5



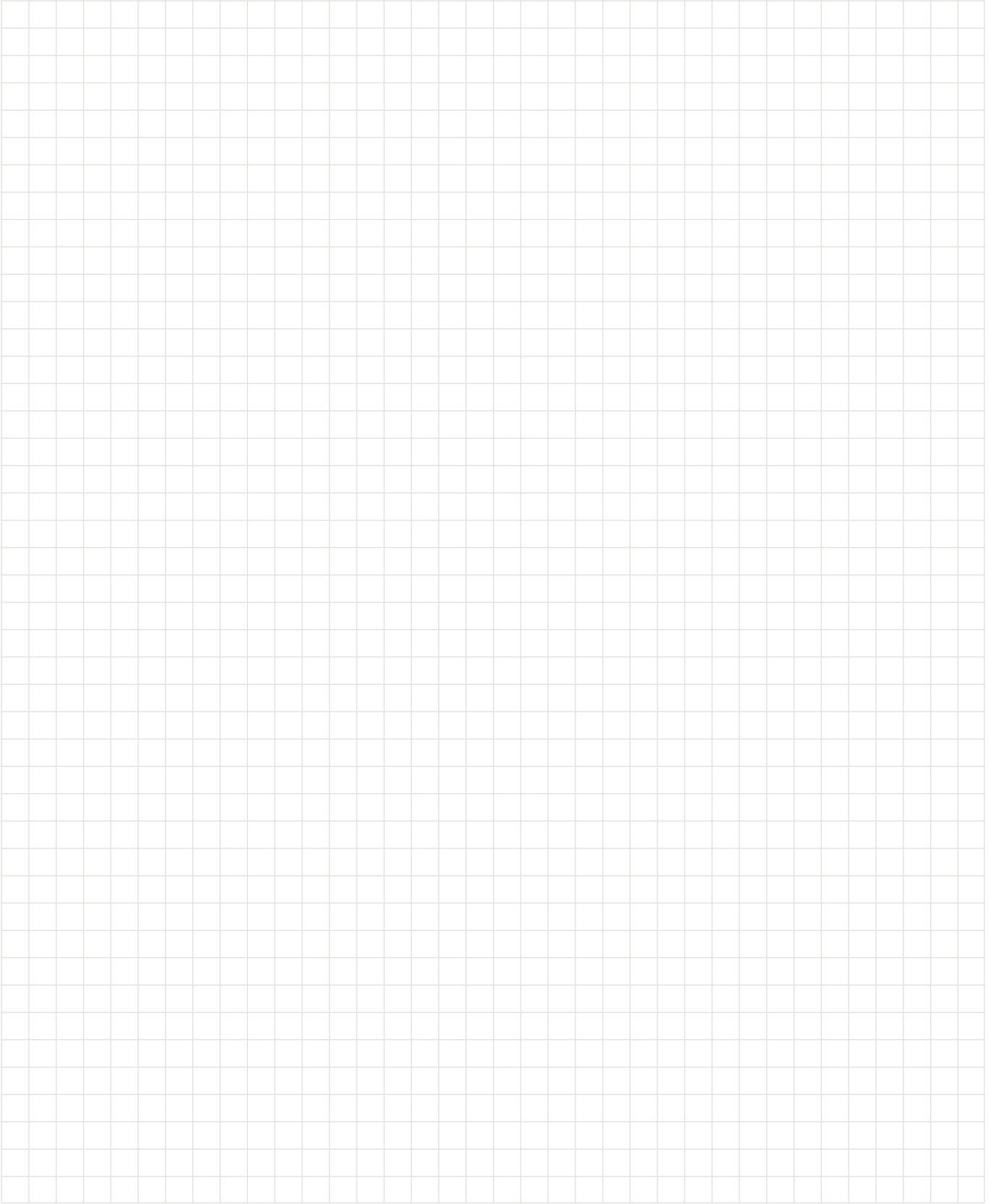

KeDrive D3-SMM

Safety encoder box

Product properties

- Decentral encoder evaluation
- Reduction of wiring
- Flexible range of application
- Fast monitoring of dynamics



Short description

The certified encoder box decentrally reads in encoder signals as well as additional safe inputs and outputs and transmits them to the controller via a cable. The inputs enable the connection of safe buttons, switches or other operating elements directly at the machine or close to the robot. All outputs are used for safe control of the motor brakes or can be freely assigned to other tasks.

To ensure that the brakes are released safely (even without control cabinet), e.g. to prepare robots for transport, safety functions are implemented directly in the encoder box.

The encoder box is connected via the EtherCAT system bus. The FSoE safety profile enables the safe exchange of actual values and control commands.

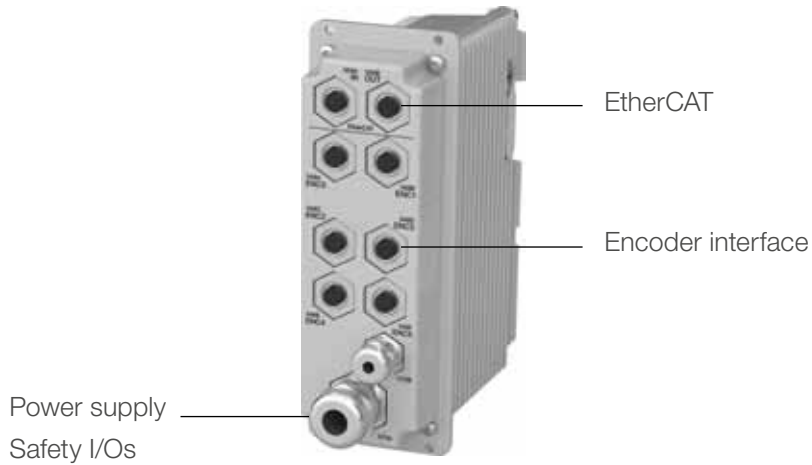

Type code

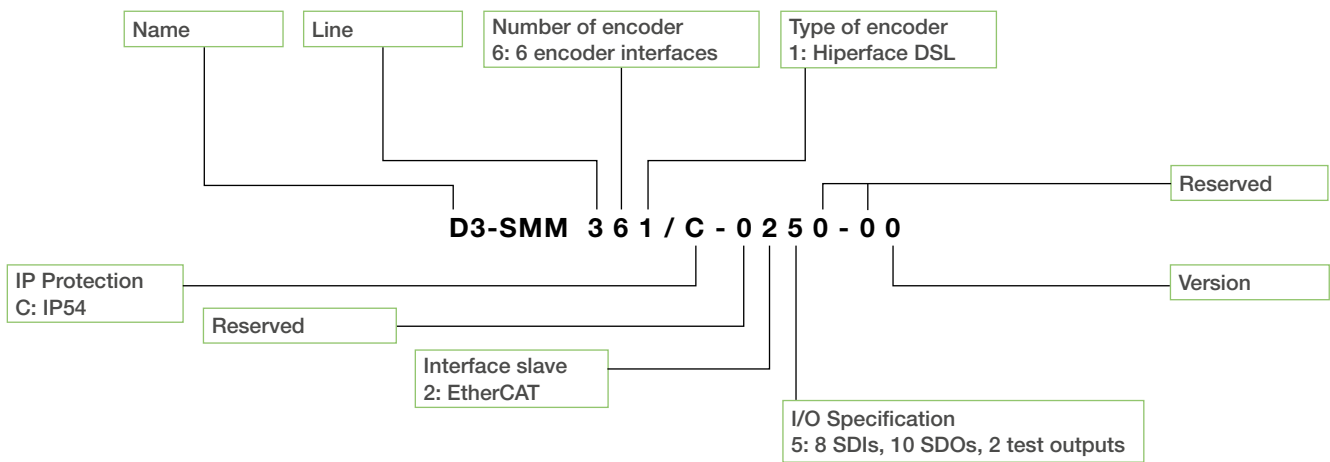

KeDrive D3-SMM

Safety encoder box

Internal safety functions

SBC Safe Brake Control	Safe control and monitoring of an external brake
SLS Safely-Limited Speed	Monitoring of a speed limit value

Digital safety inputs

Number of digital inputs	8
OSSD-capable	yes
Number of test outputs for cross-wire monitoring	2

Digital safety outputs

Number of digital outputs	10
Nominal voltage	24 V DC
Nominal current of digital outputs	1 x 2 A; 5 x 1 A; 4 x 0.5 A
Overload protection / short-circuit proof	Yes

Interfaces

EtherCAT	2 connections
Protocols	CoE, FSoE
Encoder interfaces	6 x Hiperface DSL

Dimensions, weight

Dimensions HxWxD	160 x 62 x 131 mm
Weight	1,950 g

Environmental conditions

Operating temperature	+5 °C to +55 °C
Storage temperature	-40 °C to +70 °C
Relative air humidity	10% to 95% (non-condensing)
Vibration resistance / shock resistance	Acc. to EN 61131-2

General

Supply voltage	24 V DC, 19.2 V to 30 V, acc. to EN 61131-2
Current consumption incl. encoder without I/Os	typ. 600 mA
Max. input current	6.5 A
Max. total power consumption	10 W
Additional power consumption safety technology I/Os	Under load: 144 W
Protection rating	IP54
Certification	CE, ATEX, TÜV, UL
Cycle time	125 µs / 4 ms (safety functions)
Safety class for I/Os	Up to PLe Category 4 acc. to EN 13849-1 SIL3 acc. to EN 61508 Up to SIL3 acc. to EN 61508

Wiring of encoder box

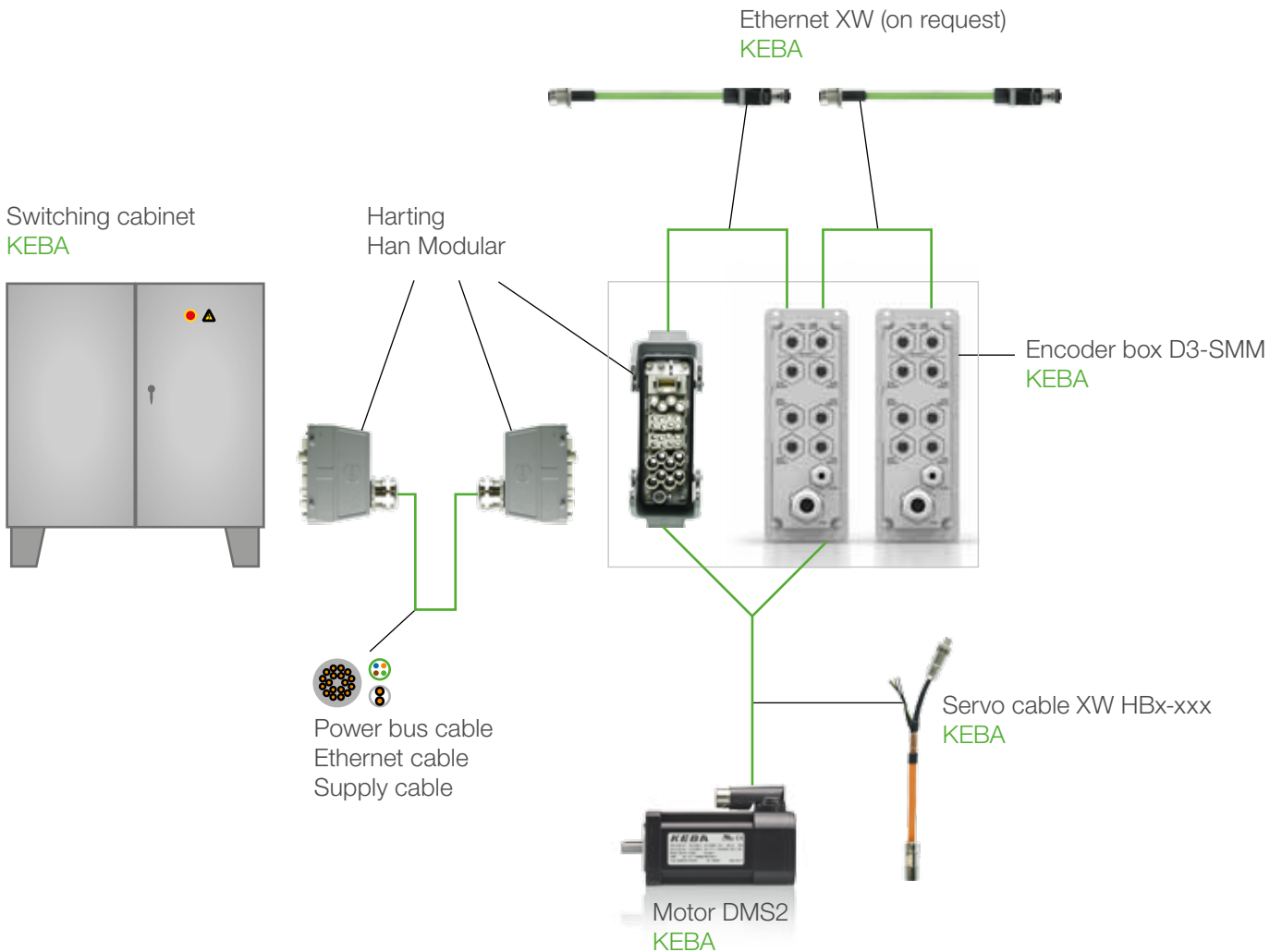

KeDrive D3-SMM

Encoder box accessories

EtherCAT cable XW xxx-xxx M12 -> RJ45 (on request)

Cable for communication between encoder box and D3-DU control unit.

- Cat 5



Suitable for D3-SMM 3xx/x

Type	Network connection cable
Specification	Cat 5, Cat 5e
Shielding	SF/UTP
Connection type	M12, RJ45
Plug design	straight
Cable length	0.5 m

EtherCAT cable XW xxx-xxx M12 - M12 (on request)

Cable for communication between two encoder boxes.

- Cat 5



DIN rail holder D3-XT 250/A

Optional for mounting the encoder box on a DIN rail.

- Metal



Suitable for D3-SMM 3xx/x

Type	DIN rail mounting set
Material	Metal

Connector set D3-XT 251/A

Optional 3 x M12 round connectors for connecting the encoders to the encoder box.

- IP67
- Metal



Suitable for D3-SMM 3xx/x

Type	M12 connector
Number	3
Protection class	IP67

Blind plug set D3-XT 252/A

Optional 20 x M12 blind plugs for plugging the encoder connectors on the encoder box.

- IP67
- Plastic



Suitable for D3-SMM 3xx/x

Type	Blind plugs M12
Protection class	IP67

KeDrive D3 Motor cables

Encoder cable XW Exx-xxx / XW Rxx-xxx

For connecting DMS2 motors with Hiperface encoders or resolvers to a KeDrive D3-DA axis module



Type code



Power cable XW Pxx-xxx / XW Hxx-xxx

For connecting DMS2 motors to a KeDrive D3-DA axis module



Type code

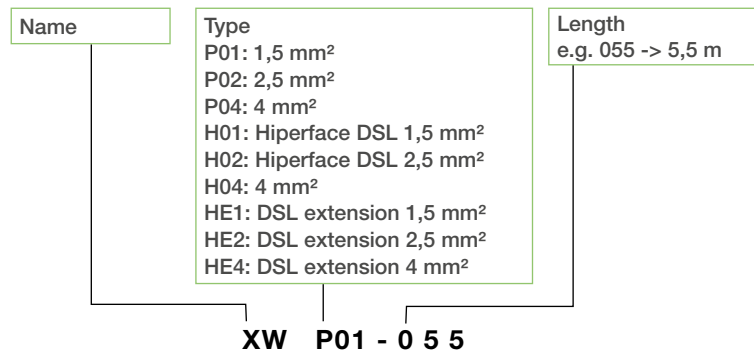

Power cable XW HBx-xxx

For connecting DMS2 motors to a KeDrive D3-DA axis module and an encoder box



Type code

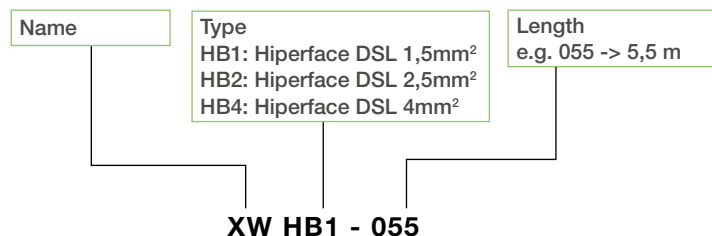

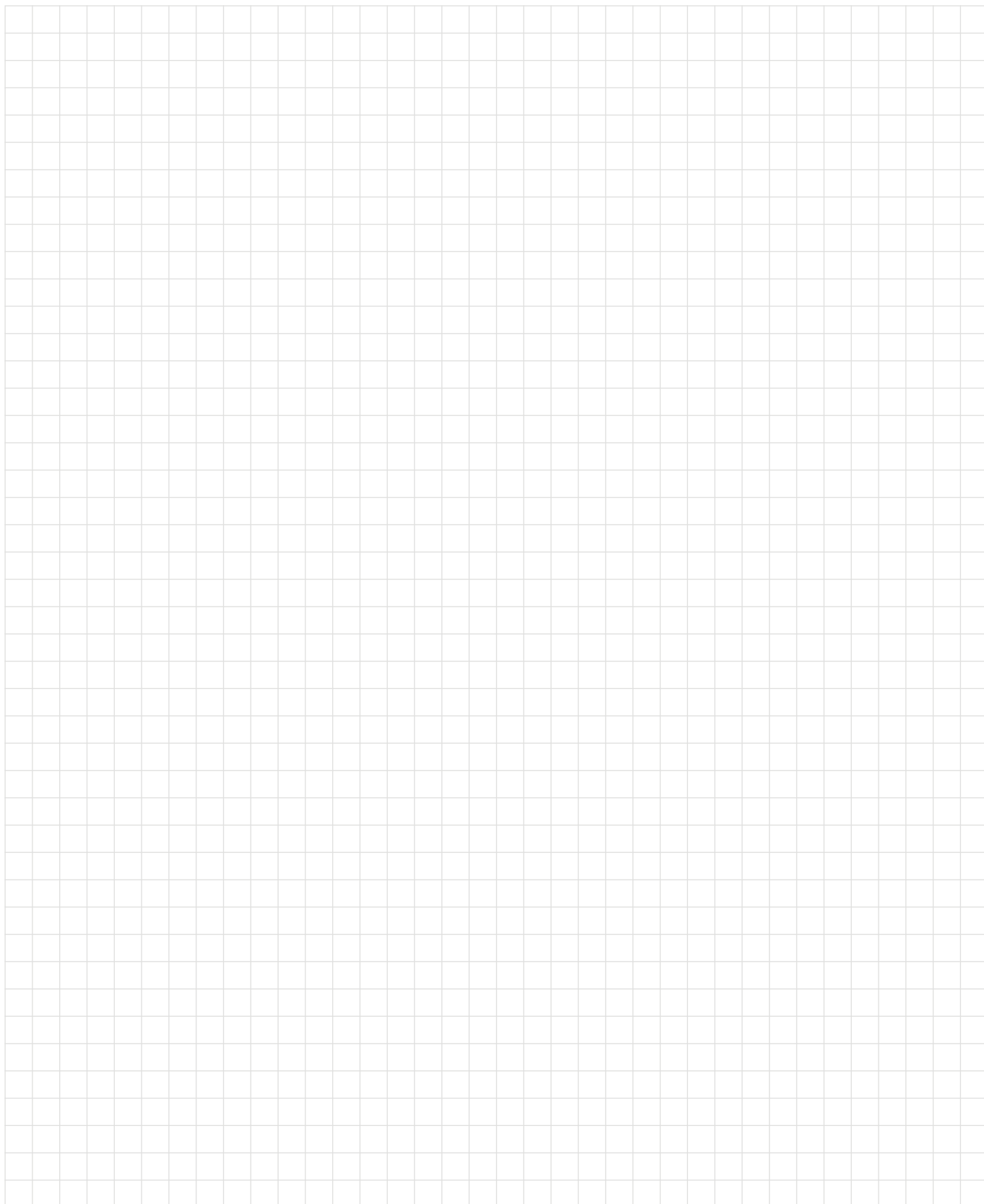

KeDrive D3

Selection guide

Selection aid motor and encoder cable

	D3-DA 3xx/x-xx1x-00	D3-DA 3xx/x-xx2x-00
Hiperface 128 periodes DMS2-xxx-xxxx-xx-xx1xxx-xxxx-x	X	
Hiperface 16 periodes DMS2-xxx-xxxx-xx-xx2xxx-xxxx-x	X	
Hiperface DSL optical DMS2-xxx-xxxx-xx-xx5xxx-xxxx-x		X
Resolver DMS2-xxx-xxxx-xx-xx90xx-xxxx-x	X	

	XW E10-xxx XW P0x-xxx	XW R10-xxx XW Pxx-xxx	XW Hxx-xxx
Hiperface 128 periodes DMS2-xxx-xxxx-xx-xx1xxx-xxxx-x	X		
Hiperface 16 periodes DMS2-xxx-xxxx-xx-xx2xxx-xxxx-x	X		
Hiperface DSL optical DMS2-xxx-xxxx-xx-xx5xxx-xxxx-x			X
Resolver DMS2-xxx-xxxx-xx-xx90xx-xxxx-x		X	

	XW Hx1-xxx XW P01-xxx	XW Hx2-xxx XW P02-xxx	XW Hx4-xxx XW P04-xxx	XW P06-xxx
DMS2-058	X			
DMS2-070	X			
DMS2-091	X			
DMS2-100	X			
DMS2-142*	X			
DMS2-142-0260-30		X		
DMS2-142-0290-30		X		
DMS2-142-0320-30		X		
DMS2-142-0350-30		X		
DMS2-142-0380-30		X		
DMS2-142-0320-45			X	
DMS2-142-0350-45				X
DMS2-142-0380-45				X
DMS2-190*	X			
DMS2-190-0560-20		X		
DMS2-190-0680-20			X	
DMS2-190-0800-20				X
DMS2-190-0560-30				X
DMS2-190-0680-30				X
DMS2-190-0800-30				on request
DMS2-240*				X
DMS2-240-1200-20				on request
DMS2-240-0730-30				on request
DMS2-240-1200-30				on request

*variations

Step	Example	Help
1 Determine the drive requirements <ul style="list-style-type: none"> • Torque, speed, power,... • Interfaces, functions • Number of axes 	Servo drive for a handling axis <ul style="list-style-type: none"> • Effective torque 4.5 Nm • Maximum torque 8 Nm • Speed 2,500 rpm • 3-axis 	Support from KEBA during design
2 Selection of the power element - motor combination	KeDrive D3 triple-axis module <ul style="list-style-type: none"> • Standstill continuous torque 5 Nm • Maximum torque 15 Nm • Maximum speed 3000 rpm 	-> KeDrive D3-DA axis controllers -> „KeDrive DMS2 Synchronous Motors“ Catalogue
3 Selection of the supply <ul style="list-style-type: none"> • Supply voltage • Supply power for drives • Supply power for 24 V 	KeDrive D3 supply unit <ul style="list-style-type: none"> • 10 kW • 20 A auxiliary voltage supply 	-> KeDrive D3-DP supply unit
4 Define the control performance <ul style="list-style-type: none"> • Number of synchronized axes • Number of unsynchronized axes • Number of robot kinematics 	KeDrive D3 control unit <ul style="list-style-type: none"> • Mean performance • 3 synchronized axes 	-> KeDrive D3-DU control module
5 Selection of the accessories <ul style="list-style-type: none"> • Line filter • Brake resistors • Connection technology 	<ul style="list-style-type: none"> • Line filter D3-XF 025/A-0612-00 • XW E10-050 • XW P01-050 	-> particular accessories chapter -> KeDrive D3 motor cables

KeDrive D3

Hiperface configuration

Example of a typical configuration with standard Hiperface encoders

Name	Model	Use
Line filter	D3-XF 025/A-0612-00	For satisfying the EMC guidelines
Control module	D3-DU-335/A-0150-00	For executing the machine application (Model is dependent on the required power and safety requirement)
CFast	D3-XC 340/A	Required for each D3-DU 3xx/x-xxxx-00 for operating system, application, parameter sets etc.
Safety connector set	D3-XT 215/A	Optional for option D3-DU 3x5/x-xx50-00
Supply unit	D3-DP 300/A-1050-00	For generating the supply voltage for control unit and axis controller. Min. 1x for per machine
Supply-unit connector set	D3-XT 220/A	Required for each supply unit D3-DP300/x-xxxx-00
Brake resistor	VHPR 300 V 90R J	Required for each supply unit D3-DP300/x-xxxx-00 (Model is dependent on the application)
Axis controller	D3-DA 330/A-0111-00	For driving servo motors. Min. 1x required per machine. (Model is dependent on the application)
Axis-controller connector set	D3-XT 230/A	Required for each axis controller D3-DA 3xx/x-xxxx-00
Axis-controller motor connector set	D3-XT 231/A	Required for connecting a motor to a D3-DA 3xx/x-xxxx-00 axis controller, 1x per motor. The connector set is not required for the use of DMS2 motors with XW Pxx-xxx or XW Hxx-xxx. 1x for D3-DA 31x/x-xxxx-xx 2x for D3-DA 32x/x-xxxx-xx 3x for D3-DA 33x/x-xxxx-xx
Power cable	XW P01-050	For connecting DMS2 motors with Hiperface encoders to a D3-DA 3xx/x-xx11-00 axis controller
Encoder cable	XW E10-050	For connecting DMS2 motors with Hiperface encoders to a D3-DA 3xx/x-xx11-00 axis controller
Motor	DMS2-070-0024-30-B11MG1-Q000-0	
Software	KeStudio U4	Min. 1x required per customer for creating the machine application
	KeStudio DriveManager D3	Min. 1x required per customer for configuring the axis controller
	KeStudio SafeEdit	Min. 1x required per customer for using the D3-DU 3x5/x-xx50-00 safety option
Licenses	KeMotion, KeSafe etc.	Required for each D3-DU 3xx/x-xxxx-00 control module

Hiperface wiring

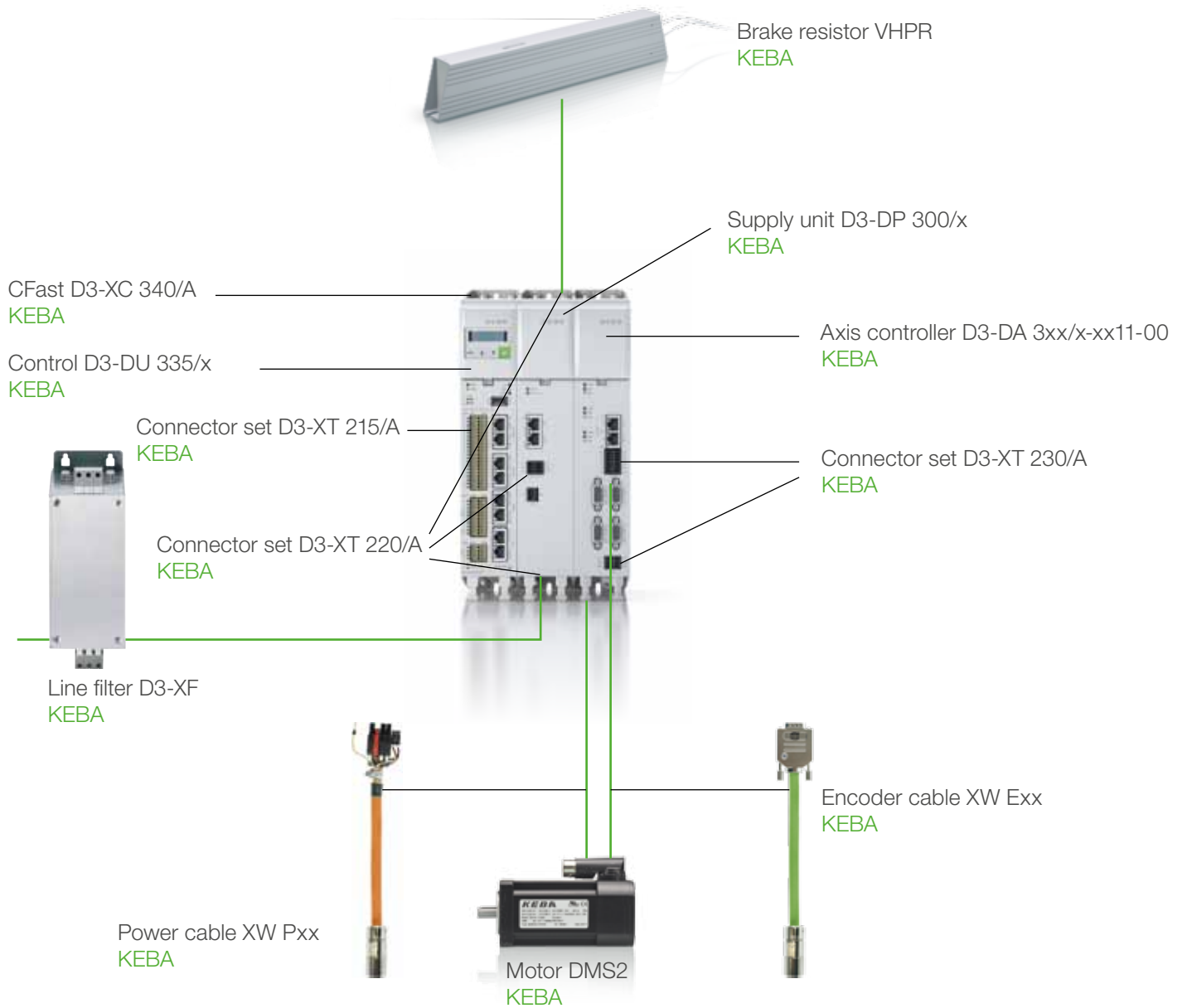

KeDrive for Motion

Hiperface DSL configuration

Example of a typical configuration with Hiperface-DSL encoders

Name	Model	Use
Line filter	D3-XF 025/A-0612-00	For satisfying the EMC guidelines
Control module	D3-DU-335/A-0150-00	For executing the machine application (Model is dependent on the required power and safety requirement)
CFast	D3-XC 340/A	Required for each D3-DU 3xx/x-xxxx-00 for operating system, application, parameter sets etc.
Safety connector set	D3-XT 215/A	Optional for option D3-DU 3x5/x-xx50-00
Supply unit	D3-DP 300/A-1050-00	For generating the supply voltage for control unit and axis controller. Min. 1x for per machine
Supply-unit connector set	D3-XT 220/A	Required for each supply unit D3-DP300/x-xxxx-00
Brake resistor	VHPR 300 V 90R J	Required for each supply unit D3-DP300/x-xxxx-00 (Model is dependent on the application)
Axis controller	D3-DA 330/A-0121-00	For driving servo motors. Min. 1x required per machine (Model is dependent on the application)
Axis-controller connector set	D3-XT 230/A	Required for each axis controller D3-DA 3xx/x-xxxx-00
Axis-controller motor connector set	D3-XT 231/A	Required for connecting a motor to a D3-DA 3xx/x-xxxx-00 axis controller, 1x per motor. The connector set is not required for the use of DMS2 motors with XW Pxx-xxx or XW Hxx-xxx. 1x for D3-DA 31x/x-xxxx-xx 2x for D3-DA 32x/x-xxxx-xx 3x for D3-DA 33x/x-xxxx-xx
Power cable	XW H01-050	For connecting DMS2 motors with Hiperface DSL encoders to a D3-DA 3xx/x-xx21-00 axis controller
Motor	DMS2-070-0024-30-B15MG1-Q000-0	
Software	KeStudio U4	Min. 1x required per customer for creating the machine application
	KeStudio DriveManager D3	Min. 1x required per customer for configuring the axis controller
	KeStudio SafeEdit	Min. 1x required per customer for using the D3-DU 3x5/x-xx50-00 safety option
Licenses	KeMotion, KeSafe etc.	Required for each D3-DU 3xx/x-xxxx-00 control module

Hiperface DSL wiring

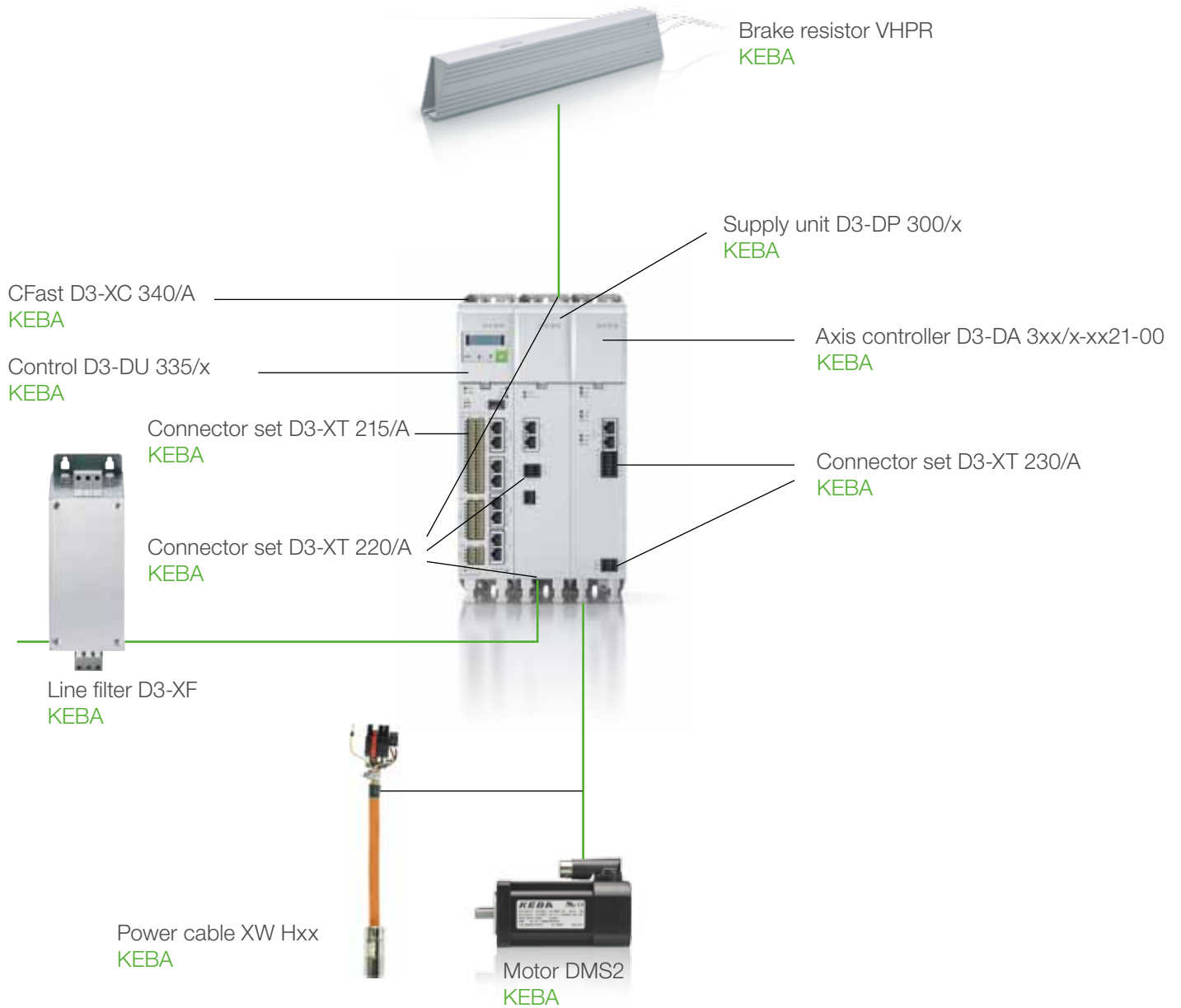

Fit for the future with KEBA.

Founded in 1968, KEBA AG is an internationally successful electronics company based in Linz/Austria with subsidiaries around the world.

In line with its credo, "Automation by innovation", KEBA has been developing and producing inventive, top-quality automation solutions for almost 50 years for industrial, banking, services and energy automation branches. Indeed, as a result of competence, experience and courage, KEBA is the technology and innovation leader in its market segments. Extensive development and production expertise represents a guarantee for the highest quality.

www.keba.com

KEBA AG Headquarters, Gewerbepark Urfahr, 4041 Linz/Austria,
Phone: +43 732 7090-0, Fax: +43 732 730910, keba@keba.com

KEBA Group worldwide

China • Germany • Italy • Japan • Netherlands
Austria • Romania • South Korea • Taiwan
Czech Republic • Turkey • USA



KEBA®

Automation by innovation.