

Data sheet | Item number: 221-612

COMPACT Splicing Connector; for all conductor types; max. 6 mm²; 2-conductor; with levers; transparent housing; Surrounding air temperature: max 85°C (T85); 6,00 mm²; transparent

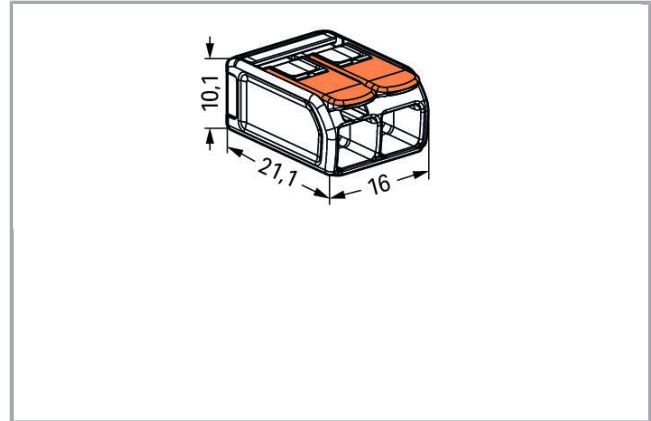

www.wago.com/221-612



RoHS Compliant

[BOMcheck.net](https://www.bomcheck.net)

Subject to changes.

WAGO Kontakttechnik GmbH & Co. KG
Hansastr. 27
32423 Minden
Phone: +49571 887-0 | Fax: +49571 887-169
Email: info.de@wago.com | Web: www.wago.com

Do you have any questions about our products?
We are always happy to take your call at +49 (571) 887-44222.



Item description

Your Benefits:

- Easy to use: Pull the lever up, insert a conductor and push the lever back down
- Available as 2-, 3- and 5-wire connectors
- Easily terminate conductors for all conductors from 0.5 to 6 mm² (20 ... 10 AWG).
- Time savings for installers and device manufacturers.
- Quickly install devices with higher levels of power consumption.
- Safely install long cable runs with larger conductor cross sections.
- Mounting carrier for installation conforming to standards
- Custom carriers are possible

Safety information 1:

In grounded power lines

Data

Electrical data

Subject to changes.

WAGO Kontakttechnik GmbH & Co. KG
Hansastr. 27
32423 Minden
Phone: +49571 887-0 | Fax: +49571 887-169
Email: info.de@wago.com | Web: www.wago.com

Do you have any questions about our products?
We are always happy to take your call at +49 (571) 887-44222.

Ratings per IEC/EN 60664-1

Rated voltage (II / 2)	450 V
Rated impulse voltage (II / 2)	4 kV
Rated current	41 A
Legend (ratings)	(II / 2) \triangleq Overvoltage category II / Pollution degree 2

Approvals per UL 1059

Rated voltage UL (Use Group C)	600 V
Rated current UL (Use Group C)	30 A

Connection data

Connection technology	CAGE CLAMP [®]
Actuation type	Lever
Connectable conductor materials	Copper
Nominal cross section	6 mm ²
Solid conductor	0.5 ... 6 mm ² / 20 ... 10 AWG
Stranded conductor	0.5 ... 6 mm ² / 20 ... 10 AWG
Fine-stranded conductor	0.5 ... 6 mm ² / 20 ... 10 AWG
Strip length	12 ... 14 mm / 0.47 ... 0.55 inch
Total number of connection points	2
Total number of potentials	1
Type of wiring	Side-entry wiring

Geometrical Data

Width	16 mm / 0.63 inch
Height	10.1 mm / 0.398 inch
Depth	21.1 mm / 0.831 inch

Material Data

Color	transparent
Flammability class per UL94	V2
Weight	3 g

Subject to changes.

Environmental Requirements



Surrounding air (operating) temperature	85 °C
Continuous operating temperature	105 °C
T-Marking per EN 60998	T85

Commercial data



Packaging type	BOX
Country of origin	CH
GTIN	4055143704168
Customs Tariff No.	85369010000

Approvals / Certificates

Ship Approvals

Logo	Approval	Additional Approval Text	Certificate name
	ABS American Bureau of Shipping	EN 60998	18- HG1755093- PDA
	DNV GL Det Norske Veritas, Germanischer Lloyd	EN 60998	TAE000015T
	LR Lloyds Register	EN 60998	04/20013 (E8)

UL-Approvals

Logo	Approval	Additional Approval Text	Certificate name
	UL Underwriters Laboratories Inc. WIRE CONNECTOR 667F	UL 486C	E69654
	UL Underwriters Laboratories Inc. GROUNDING EQUIP 64KA	UL 467	E201573



Subject to changes.

WAGO Kontakttechnik GmbH & Co. KG
Hansastr. 27
32423 Minden
Phone: +49571 887-0 | Fax: +49571 887-169
Email: info.de@wago.com | Web: www.wago.com

Do you have any questions about our products?
We are always happy to take your call at +49 (571) 887-44222.

Compatible products

Mounting adapter

	Item no.: 221-510 Mounting carrier; 221 Series - 6 mm ² ; for DIN-35 rail mounting/screw mounting; orange	www.wago.com/221-510
	Item no.: 221-510/000-006 Mounting carrier; 221 Series - 6 mm ² ; for DIN-35 rail mounting/screw mounting; blue	www.wago.com/221-510/000-006
	Item no.: 221-510/000-053 Mounting carrier; 221 Series - 6 mm ² ; for DIN-35 rail mounting/screw mounting; dark gray-yellow	www.wago.com/221-510/000-053

Downloads

Documentation

Additional Information

Technical explanations	03-abr-2019	pdf 2.1 MB	Download
------------------------	-------------	---------------	----------

CAD/CAE-Data

CAD data

2D/3D Models 221-612	URL	Download
----------------------	-----	----------

Installation Notes

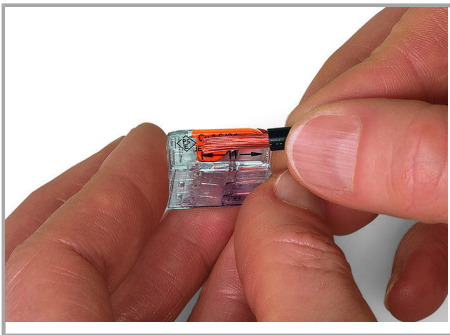

Strip conductor to 11 mm (0.43 inch).

Subject to changes.

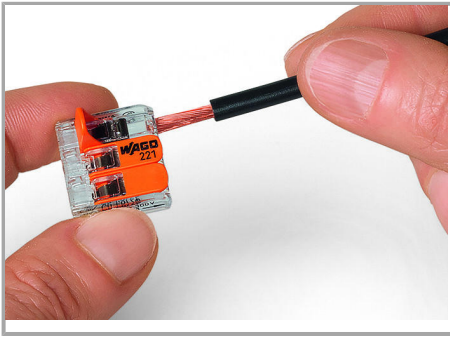

Termination: Lift the lever to open the clamping unit and insert a stripped conductor.

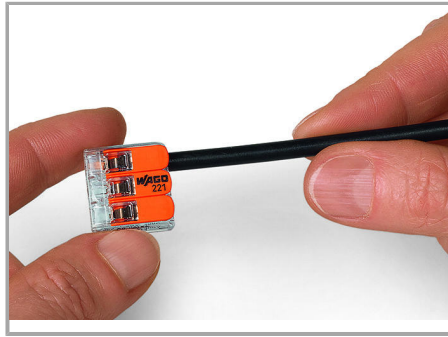

Then, lower the lever to close the clamp.

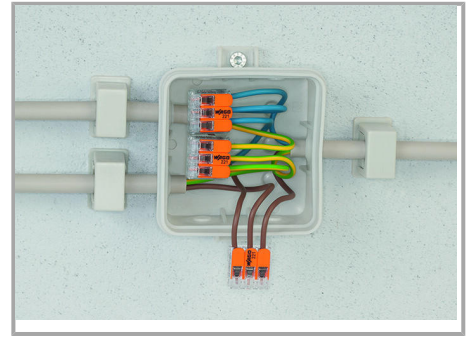

Wiring fine-stranded conductors in a junction box.

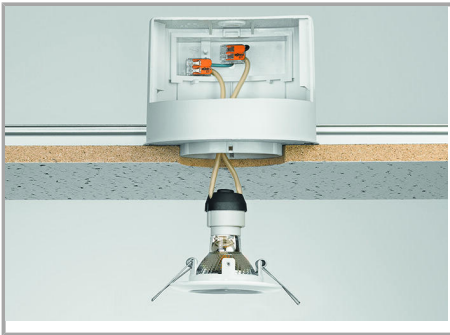

Custom low-voltage lighting system



Lighting distribution in ceiling canopy



Pendant light connection in suspended ceilings

Subject to changes.

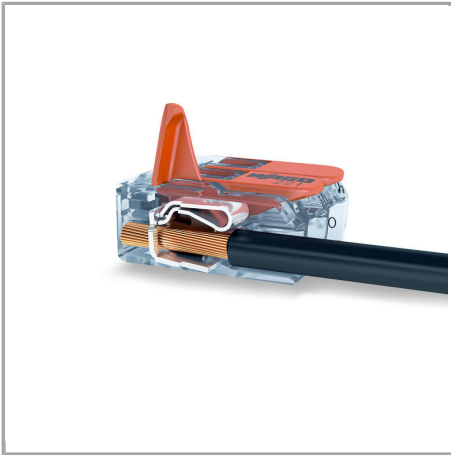

COMPACT Splicing Connectors for All
Conductor Types, 4 mm² (12 AWG), 221
Series

Subject to changes.