

**Data sheet | Item number: 2857-550**

Current signal conditioner; Current input signal; Current and voltage output signal; Digital and relay output; Configuration via software; Supply voltage: 24 VDC; 22.5 mm module width

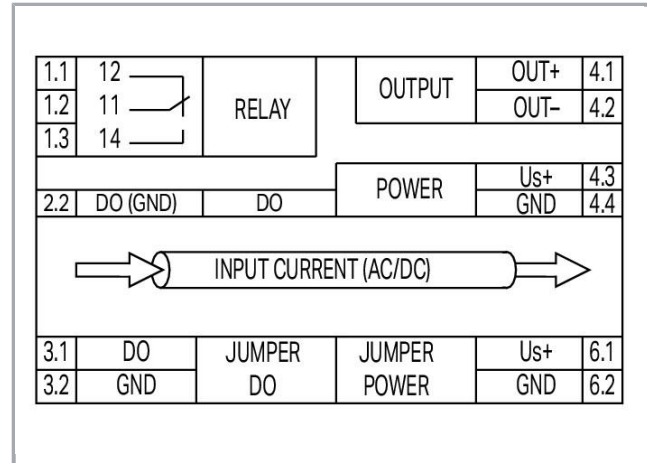

[www.wago.com/2857-550](http://www.wago.com/2857-550)

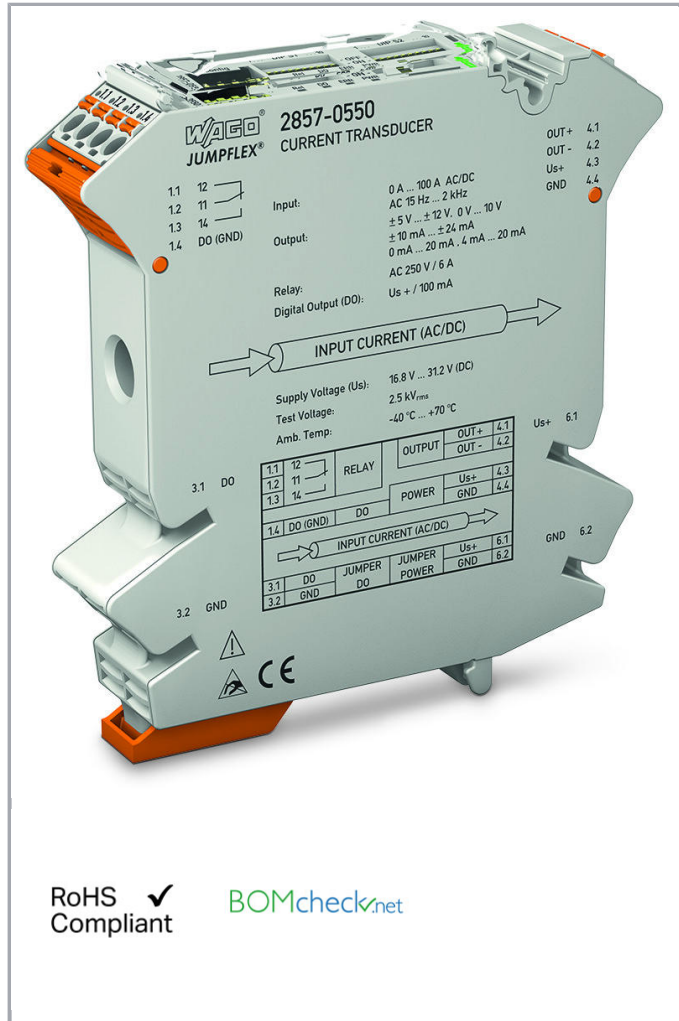

Subject to changes.

WAGO Kontakttechnik GmbH & Co. KG  
 Hansastr. 27  
 32423 Minden  
 Phone: +49571 887-0 | Fax: +49571 887-169  
 Email: [info.de@wago.com](mailto:info.de@wago.com) | Web: [www.wago.com](http://www.wago.com)

Do you have any questions about our products?  
 We are always happy to take your call at +49 (571) 887-44222.

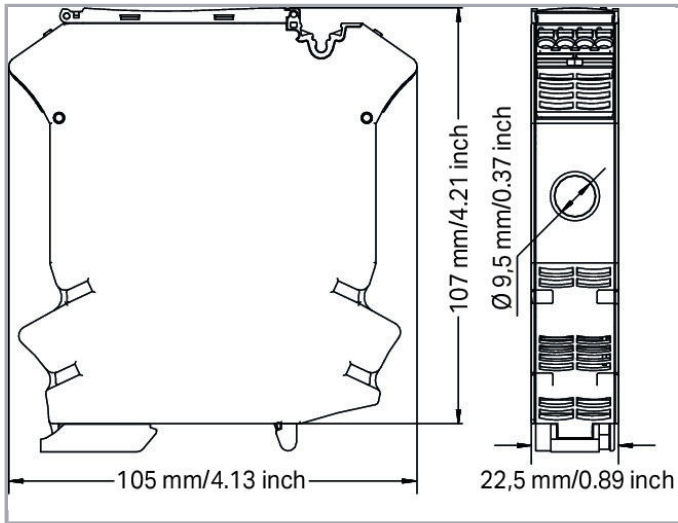

2857-550  
DIP Switch Adjustability

• = ON    Default

DIP Switch S1

Measurement method	Filter	Analog Output Inverted	Output Signal (Bipolar for Arithmetic Mean Value)	
1	2	3	4 5 6	7 8
True RMS	inactive	Not inverted		{ ± 10 ... 20 mA
Arithmetic mean value (Output signal bipolar)	active	Inverted		4 ... 20 mA
				{ ± 10 ... 10 V
				2 ... 10 V
				{ ± 10 ... 10 mA
				2 ... 10 mA
				{ ± 10 ... 5 V
				1 ... 5 V

DIP Switch S1

Measurement Range Underflow	Measurement Range Overflow	Overcurrent (Input Signal End Value + 20 %)	Digital Output (DO)/Relay
7	8	9	10
Lower limit of output range -5%*	Upper limit of output range +2.5%*	Upper limit of output range +5%	OFF
Lower limit of output range	Upper limit of output range +2.5%	Upper limit of output range +5%	DO U <sub>+</sub> switching - Relay puts in
Lower limit of output range	Upper limit of output range	Lower limit of output range -5%	DO GND switching - Relay drops out
Lower limit of output range -5%	Upper limit of output range +5%	Upper limit of output range	Off

DIP Switch S2

Start Value				End Value		
1	2	3	4	5	6	7
A / % (RMS)		A / % (Arithmetic Mean Value)		A / %		
Software configuration (0)		Software configuration (100)		Software configuration (100)		
•	•	•	•	•	•	•
			-100			100
•	•	•	-75	•	•	90
•	•	•	-50	•	•	70
•	•	•	-25	•	•	50
•	•	•	-10	•	•	30
•	•	•	0	•	•	20
•	•	•	5	•	•	10
•	•	•	10			
•	•	•	15			
•	•	•	20			
•	•	•	25			
•	•	•	30			
•	•	•	35			
•	•	•	40			
•	•	•	45			
•	•	•	50			

### Item description

#### Short description:

The 2857-550 Current Signal Conditioner measures AC/DC currents up to 100 A, while converting the measured current into an analog standard signal at the output.

#### Features:

- Both digital signal output and relay with changeover contact react to configured measuring range limits (switching ON/OFF delay and threshold value switch function configurable with up to two threshold values).
- Clipping capability provides analog signal limitation to output end values.
- Adjustable software filter
- Input/Output response simulation via configuration display
- Safe 3-way isolation with 3 kV test voltage per EN 61010-1

#### Note:

Additional setting options via interface configuration software or interface configuration app

### Data

#### Technical Data

### Configuration

Configuration options

DIP switches

WAGO interface configuration software

Subject to changes.

WAGO Kontakttechnik GmbH & Co. KG

Hansastr. 27

32423 Minden

Phone: +49571 887-0 | Fax: +49571 887-169

Email: info.de@wago.com | Web: www.wago.com

Do you have any questions about our products?

We are always happy to take your call at +49 (571) 887-44222.



WAGO interface configuration app  
WAGO configuration display

## Input

Input signal type	Current
Input signal, current	AC 0.5 ... 100 A; DC $\pm$ 100 A
Frequency range	15 ... 1000 Hz
Max. input current	100 A AC/DC
Response threshold	500 mA (AC); 250 mA (DC)
Resolution (current)	10 mA

## Output – Analog

Output signal type	Current Voltage
Output signal voltage	$\pm$ 5 V; 0 ... 5 V; 1 ... 5 V; $\pm$ 10 V; 0 ... 10 V
Output signal current	$\pm$ 10 mA; 0 ... 10 mA; 2 ... 10 mA; $\pm$ 20 mA; 0 ... 20 mA; 4 ... 20 mA
Load impedance (output/voltage)	$\geq$ 1 k $\Omega$
Load impedance (output/current)	$\leq$ 600 $\Omega$

## Output – Digital

Max. switching voltage (DO)	Supply voltage (applied) – 0.3 V
Max. continuous current (DO)	100 mA (no internal restriction)
Number of switching thresholds (DO)	1 or 2 (adjustable)
Configurable rise/fall delay time (DO)	0 ... 60 s (via software)

## Output – Relay

Dielectric strength open contact (AC, 1 min)	1 kV <sub>rms</sub>
Number of changeover/switchover contacts	1
Contact material (relay)	AgNi + Au
Max. switching voltage	AC 250 V
Limiting continuous current (relay; terminal block assembly)	6 A ( $\leq$ 60 °C); 3 A (60 ... 70 °C)
Dielectric strength open contact (AC, 1 min)	1 kV <sub>rms</sub>
Pull-in time (typ.)	8 ms
Drop-out time (typ.)	4 ms
Bounce time (typ)	8 ms
Number of switching thresholds (relay)	1 or 2 (adjustable)
Configurable rise/fall delay time (relay)	0 ... 60 s (via software)

Subject to changes.



## Signal processing

Measuring procedure	True RMS measurement (TRMS); Arithmetic mean value
Max. operating frequency	3.3 kHz
Software filter; adjustable	moving mean value (filtering level: 30)
Step response typ.	60 ms (DC; at software filter 3/default setting); 250 ms (AC)

## Measurement error

Transmission error max.	$\leq 1\%$ (of the full scale value)
Temperature coefficient	$\leq 0.01\%/K$

## Power supply

Type of power supply	24 VDC
Nominal supply voltage $U_S$	DC 24 V
Supply voltage range	$\pm 30\%$
Current consumption at supply voltage	$\leq 50\text{ mA} (+ I_{DO})$

## Safety and protection:

Test voltage (input/output/supply)	AC 3 kV; 50 Hz; 1 min
Test voltage (measuring circuit/output)	AC 4 kV; 50 Hz; 1 min
Protection class	IP20

## Connection data

Connection technology	Push-in CAGE CLAMP <sup>®</sup>
WAGO terminal	picoMAX <sup>®</sup> 5.0
Solid conductor	0.2 ... 2.5 mm <sup>2</sup> / 24 ... 12 AWG
Fine-stranded conductor	0.2 ... 2.5 mm <sup>2</sup> / 24 ... 12 AWG
Strip length	9 ... 10 mm / 0.35 ... 0.39 inch
Feedthrough for measurement conductor	$\varnothing 9.5\text{ mm}$

## Geometrical Data

Width	22.5 mm / 0.886 inch
Height from upper-edge of DIN-35 rail	107 mm / 4.213 inch
Depth	105 mm / 4.134 inch

Subject to changes.

WAGO Kontakttechnik GmbH & Co. KG  
 Hansastr. 27  
 32423 Minden  
 Phone: +49571 887-0 | Fax: +49571 887-169  
 Email: [info.de@wago.com](mailto:info.de@wago.com) | Web: [www.wago.com](http://www.wago.com)

Do you have any questions about our products?  
 We are always happy to take your call at +49 (571) 887-44222.

## Mechanical data

Type of mounting	DIN-35 rail
------------------	-------------

## Material Data

Fire load	1.918 MJ
Weight	102.9 g

## Environmental Requirements

Surrounding air (operating) temperature	-40 ... 70 °C
Surrounding air (storage) temperature	-40 ... 85 °C

## Standards and specifications

Conformity marking	CE
EMC immunity to interference	EN 61000-6-2; EN 61326-2-3; EN 50121-3-2
EMC emission of interference	EN 61000-6-4; EN 61326-2-3; EN 50121-3-2
Standards/specifications	EN 61010-1; EN 61373

## Commercial data

Product Group	6 (Interface Electronics)
Packaging type	bag
Country of origin	DE
GTIN	4050821676997
Customs Tariff No.	85437090300

## Compatible products

### check



Item no.: 735-500

Test pin; 1 mm Ø; with solder connection for test wire

[www.wago.com/735-500](http://www.wago.com/735-500)

### tools

Subject to changes.



**Item no.: 210-720**  
Operating tool; Blade: 3.5 x 0.5 mm; with a partially insulated shaft

[www.wago.com/210-720](http://www.wago.com/210-720)

### Jumper



**Item no.: 281-482**  
Comb-style jumper bar; insulated; 2-way; IN = IN terminal block; gray

[www.wago.com/281-482](http://www.wago.com/281-482)



**Item no.: 859-402**  
Push-in type jumper bar; 2-way; Nominal current 18 A; insulated; light gray

[www.wago.com/859-402](http://www.wago.com/859-402)



**Item no.: 859-402/000-005**  
Push-in type jumper bar; 2-way; Nominal current 18 A; insulated; red

[www.wago.com/859-402/000-005](http://www.wago.com/859-402/000-005)



**Item no.: 859-402/000-006**  
Push-in type jumper bar; 2-way; Nominal current 18 A; insulated; blue

[www.wago.com/859-402/000-006](http://www.wago.com/859-402/000-006)



**Item no.: 859-402/000-029**  
Push-in type jumper bar; 2-way; Nominal current 18 A; insulated; yellow

[www.wago.com/859-402/000-029](http://www.wago.com/859-402/000-029)

### General accessories



**Item no.: 2857-900**  
Configuration display

[www.wago.com/2857-900](http://www.wago.com/2857-900)



**Item no.: 750-921**  
Bluetooth® Adapter; light gray

[www.wago.com/750-921](http://www.wago.com/750-921)



**Item no.: 750-923**  
Configuration cable; USB connector; Length: 2.5 m; black

[www.wago.com/750-923](http://www.wago.com/750-923)



**Item no.: 750-923/000-001**  
Configuration cable; USB connector; Length: 5 m

[www.wago.com/750-923/000-001](http://www.wago.com/750-923/000-001)



**Item no.: 857-304**  
Relay module; Nominal input voltage: 24 VDC; 1 changeover contact; Limiting continuous current: 6 A; Yellow status indicator; Module width: 6 mm; 2,50 mm<sup>2</sup>; gray

[www.wago.com/857-304](http://www.wago.com/857-304)



**Item no.: 857-979**  
Supply and through module; 2,50 mm<sup>2</sup>

[www.wago.com/857-979](http://www.wago.com/857-979)

### Marking accessories



**Item no.: 2009-110**  
Marking strips; on reel; not stretchable; plain; snap-on type; white

[www.wago.com/2009-110](http://www.wago.com/2009-110)



**Item no.: 2009-115**  
WMB-Inline; for Smart Printer; on reel; stretchable 5 - 5.2 mm; plain; snap-on type; white















[www.wago.com/2009-115](http://www.wago.com/2009-115)



**Item no.: 2009-115/000-002**  
WMB-Inline; for Smart Printer; on reel; stretchable 5 - 5.2 mm; plain; snap-on type; yellow

[www.wago.com/2009-115/000-002](http://www.wago.com/2009-115/000-002)

Subject to changes.

	<b>Item no.: 2009-115/000-006</b> WMB-Inline; for Smart Printer; on reel; stretchable 5 - 5.2 mm; plain; snap-on type; blue	<a href="http://www.wago.com/2009-115/000-006">www.wago.com/2009-115/000-006</a>
	<b>Item no.: 2009-115/000-007</b> WMB-Inline; for Smart Printer; on reel; stretchable 5 - 5.2 mm; plain; snap-on type; gray	<a href="http://www.wago.com/2009-115/000-007">www.wago.com/2009-115/000-007</a>
	<b>Item no.: 2009-115/000-012</b> WMB-Inline; for Smart Printer; on reel; stretchable 5 - 5.2 mm; plain; snap-on type; orange	<a href="http://www.wago.com/2009-115/000-012">www.wago.com/2009-115/000-012</a>
	<b>Item no.: 2009-115/000-017</b> WMB-Inline; for Smart Printer; on reel; stretchable 5 - 5.2 mm; plain; snap-on type; light green	<a href="http://www.wago.com/2009-115/000-017">www.wago.com/2009-115/000-017</a>
	<b>Item no.: 2009-115/000-023</b> WMB-Inline; for Smart Printer; on reel; stretchable 5 - 5.2 mm; plain; snap-on type; green	<a href="http://www.wago.com/2009-115/000-023">www.wago.com/2009-115/000-023</a>
	<b>Item no.: 2009-115/000-024</b> WMB-Inline; for Smart Printer; on reel; stretchable 5 - 5.2 mm; plain; snap-on type; violet	<a href="http://www.wago.com/2009-115/000-024">www.wago.com/2009-115/000-024</a>
	<b>Item no.: 2009-141</b> Micro-WSB-Inline; on reel; plain; snap-on type; white	<a href="http://www.wago.com/2009-141">www.wago.com/2009-141</a>
	<b>Item no.: 793-501</b> WMB marking card; as card; not stretchable; plain; snap-on type; white	<a href="http://www.wago.com/793-501">www.wago.com/793-501</a>
	<b>Item no.: 793-501/000-002</b> WMB marking card; as card; not stretchable; plain; snap-on type; yellow	<a href="http://www.wago.com/793-501/000-002">www.wago.com/793-501/000-002</a>
	<b>Item no.: 793-501/000-005</b> WMB marking card; as card; not stretchable; plain; snap-on type; red	<a href="http://www.wago.com/793-501/000-005">www.wago.com/793-501/000-005</a>
	<b>Item no.: 793-501/000-006</b> WMB marking card; as card; not stretchable; plain; snap-on type; blue	<a href="http://www.wago.com/793-501/000-006">www.wago.com/793-501/000-006</a>
	<b>Item no.: 793-501/000-007</b> WMB marking card; as card; not stretchable; plain; snap-on type; gray	<a href="http://www.wago.com/793-501/000-007">www.wago.com/793-501/000-007</a>
	<b>Item no.: 793-501/000-012</b> WMB marking card; as card; not stretchable; plain; snap-on type; orange	<a href="http://www.wago.com/793-501/000-012">www.wago.com/793-501/000-012</a>
	<b>Item no.: 793-501/000-017</b> WMB marking card; as card; not stretchable; plain; snap-on type; light green	<a href="http://www.wago.com/793-501/000-017">www.wago.com/793-501/000-017</a>

Subject to changes.



**Item no.: 793-501/000-023**  
WMB marking card; as card; not stretchable; plain; snap-on type; green

[www.wago.com/793-501/000-023](http://www.wago.com/793-501/000-023)



**Item no.: 793-501/000-024**  
WMB marking card; as card; not stretchable; plain; snap-on type; violet

[www.wago.com/793-501/000-024](http://www.wago.com/793-501/000-024)



**Item no.: 793-502**  
WMB marking card; as card; MARKED; 1 ... 10 (10x); not stretchable; Horizontal marking; snap-on type; white

[www.wago.com/793-502](http://www.wago.com/793-502)



**Item no.: 793-502/000-002**  
WMB marking card; as card; MARKED; 1 ... 10 (10x); not stretchable; Horizontal marking; snap-on type; yellow

[www.wago.com/793-502/000-002](http://www.wago.com/793-502/000-002)



**Item no.: 793-502/000-005**  
WMB marking card; as card; MARKED; 1 ... 10 (10x); not stretchable; Horizontal marking; snap-on type; red

[www.wago.com/793-502/000-005](http://www.wago.com/793-502/000-005)



**Item no.: 793-502/000-006**  
WMB marking card; as card; MARKED; 1 ... 10 (10x); not stretchable; Horizontal marking; snap-on type; blue

[www.wago.com/793-502/000-006](http://www.wago.com/793-502/000-006)



**Item no.: 793-502/000-007**  
WMB marking card; as card; MARKED; 1 ... 10 (10x); not stretchable; Horizontal marking; snap-on type; gray

[www.wago.com/793-502/000-007](http://www.wago.com/793-502/000-007)



**Item no.: 793-502/000-012**  
WMB marking card; as card; MARKED; 1 ... 10 (10x); not stretchable; Horizontal marking; snap-on type; orange

[www.wago.com/793-502/000-012](http://www.wago.com/793-502/000-012)



**Item no.: 793-502/000-017**  
WMB marking card; as card; MARKED; 1 ... 10 (10x); not stretchable; Horizontal marking; snap-on type; light green

[www.wago.com/793-502/000-017](http://www.wago.com/793-502/000-017)



**Item no.: 793-502/000-023**  
WMB marking card; as card; MARKED; 1 ... 10 (10x); not stretchable; Horizontal marking; snap-on type; green

[www.wago.com/793-502/000-023](http://www.wago.com/793-502/000-023)



**Item no.: 793-502/000-024**  
WMB marking card; as card; MARKED; 1 ... 10 (10x); not stretchable; Horizontal marking; snap-on type; violet

[www.wago.com/793-502/000-024](http://www.wago.com/793-502/000-024)



**Item no.: 793-503**  
WMB marking card; as card; MARKED; 11 ... 20 (10x); not stretchable; Horizontal marking; snap-on type; white

[www.wago.com/793-503](http://www.wago.com/793-503)



**Item no.: 793-503/000-002**  
WMB marking card; as card; MARKED; 11 ... 20 (10x); not stretchable; Horizontal marking; snap-on type; yellow

[www.wago.com/793-503/000-002](http://www.wago.com/793-503/000-002)















**Item no.: 793-503/000-005**  
WMB marking card; as card; MARKED; 11 ... 20 (10x); not stretchable; Horizontal marking; snap-on type; red















[www.wago.com/793-503/000-005](http://www.wago.com/793-503/000-005)

Subject to changes.



	<b>Item no.: 793-503/000-006</b> WMB marking card; as card; MARKED; 11 ... 20 (10x); not stretchable; Horizontal marking; snap-on type; blue	<a href="http://www.wago.com/793-503/000-006">www.wago.com/793-503/000-006</a>
	<b>Item no.: 793-503/000-007</b> WMB marking card; as card; MARKED; 11 ... 20 (10x); not stretchable; Horizontal marking; snap-on type; gray	<a href="http://www.wago.com/793-503/000-007">www.wago.com/793-503/000-007</a>
	<b>Item no.: 793-503/000-012</b> WMB marking card; as card; MARKED; 11 ... 20 (10x); not stretchable; Horizontal marking; snap-on type; orange	<a href="http://www.wago.com/793-503/000-012">www.wago.com/793-503/000-012</a>
	<b>Item no.: 793-503/000-017</b> WMB marking card; as card; MARKED; 11 ... 20 (10x); not stretchable; Horizontal marking; snap-on type; light green	<a href="http://www.wago.com/793-503/000-017">www.wago.com/793-503/000-017</a>
	<b>Item no.: 793-503/000-023</b> WMB marking card; as card; MARKED; 11 ... 20 (10x); not stretchable; Horizontal marking; snap-on type; green	<a href="http://www.wago.com/793-503/000-023">www.wago.com/793-503/000-023</a>
	<b>Item no.: 793-503/000-024</b> WMB marking card; as card; MARKED; 11 ... 20 (10x); not stretchable; Horizontal marking; snap-on type; violet	<a href="http://www.wago.com/793-503/000-024">www.wago.com/793-503/000-024</a>
	<b>Item no.: 793-504</b> WMB marking card; as card; MARKED; 21 ... 30 (10x); not stretchable; Horizontal marking; snap-on type; white	<a href="http://www.wago.com/793-504">www.wago.com/793-504</a>
	<b>Item no.: 793-504/000-002</b> WMB marking card; as card; MARKED; 21 ... 30 (10x); not stretchable; Horizontal marking; snap-on type; yellow	<a href="http://www.wago.com/793-504/000-002">www.wago.com/793-504/000-002</a>
	<b>Item no.: 793-504/000-005</b> WMB marking card; as card; MARKED; 21 ... 30 (10x); not stretchable; Horizontal marking; snap-on type; red	<a href="http://www.wago.com/793-504/000-005">www.wago.com/793-504/000-005</a>
	<b>Item no.: 793-504/000-006</b> WMB marking card; as card; MARKED; 21 ... 30 (10x); not stretchable; Horizontal marking; snap-on type; blue	<a href="http://www.wago.com/793-504/000-006">www.wago.com/793-504/000-006</a>
	<b>Item no.: 793-504/000-012</b> WMB marking card; as card; MARKED; 21 ... 30 (10x); not stretchable; Horizontal marking; snap-on type; orange	<a href="http://www.wago.com/793-504/000-012">www.wago.com/793-504/000-012</a>
	<b>Item no.: 793-504/000-017</b> WMB marking card; as card; MARKED; 21 ... 30 (10x); not stretchable; Horizontal marking; snap-on type; light green	<a href="http://www.wago.com/793-504/000-017">www.wago.com/793-504/000-017</a>
	<b>Item no.: 793-504/000-023</b> WMB marking card; as card; MARKED; 21 ... 30 (10x); not stretchable; Horizontal marking; snap-on type; green	<a href="http://www.wago.com/793-504/000-023">www.wago.com/793-504/000-023</a>
	<b>Item no.: 793-505</b>	

Subject to changes.

	WMB marking card; as card; MARKED; 31 ... 40 (10x); not stretchable; Horizontal marking; snap-on type; white	<a href="http://www.wago.com/793-505">www.wago.com/793-505</a>
	<b>Item no.: 793-505/000-005</b> WMB marking card; as card; MARKED; 31 ... 40 (10x); not stretchable; Horizontal marking; snap-on type; red	<a href="http://www.wago.com/793-505/000-005">www.wago.com/793-505/000-005</a>
	<b>Item no.: 793-505/000-006</b> WMB marking card; as card; MARKED; 31 ... 40 (10x); not stretchable; Horizontal marking; snap-on type; blue	<a href="http://www.wago.com/793-505/000-006">www.wago.com/793-505/000-006</a>
	<b>Item no.: 793-505/000-007</b> WMB marking card; as card; MARKED; 31 ... 40 (10x); not stretchable; Horizontal marking; snap-on type; gray	<a href="http://www.wago.com/793-505/000-007">www.wago.com/793-505/000-007</a>
	<b>Item no.: 793-505/000-012</b> WMB marking card; as card; MARKED; 31 ... 40 (10x); not stretchable; Horizontal marking; snap-on type; orange	<a href="http://www.wago.com/793-505/000-012">www.wago.com/793-505/000-012</a>
	<b>Item no.: 793-506</b> WMB marking card; as card; MARKED; 41 ... 50 (10x); not stretchable; Horizontal marking; snap-on type; white	<a href="http://www.wago.com/793-506">www.wago.com/793-506</a>
	<b>Item no.: 793-506/000-005</b> WMB marking card; as card; MARKED; 41 ... 50 (10x); not stretchable; Horizontal marking; snap-on type; red	<a href="http://www.wago.com/793-506/000-005">www.wago.com/793-506/000-005</a>
	<b>Item no.: 793-506/000-006</b> WMB marking card; as card; MARKED; 41 ... 50 (10x); not stretchable; Horizontal marking; snap-on type; blue	<a href="http://www.wago.com/793-506/000-006">www.wago.com/793-506/000-006</a>
	<b>Item no.: 793-506/000-012</b> WMB marking card; as card; MARKED; 41 ... 50 (10x); not stretchable; Horizontal marking; snap-on type; orange	<a href="http://www.wago.com/793-506/000-012">www.wago.com/793-506/000-012</a>
	<b>Item no.: 793-506/000-017</b> WMB marking card; as card; MARKED; 41 ... 50 (10x); not stretchable; Horizontal marking; snap-on type; light green	<a href="http://www.wago.com/793-506/000-017">www.wago.com/793-506/000-017</a>
	<b>Item no.: 793-5501</b> WMB marking card; as card; for terminal block width 5 - 17.5 mm; stretchable 5 - 5.2 mm; plain; snap-on type; white	<a href="http://www.wago.com/793-5501">www.wago.com/793-5501</a>
	<b>Item no.: 793-5501/000-002</b> WMB marking card; as card; for terminal block width 5 - 17.5 mm; stretchable 5 - 5.2 mm; plain; snap-on type; yellow	<a href="http://www.wago.com/793-5501/000-002">www.wago.com/793-5501/000-002</a>
	<b>Item no.: 793-5501/000-005</b> WMB marking card; as card; stretchable 5 - 5.2 mm; plain; snap-on type; red	<a href="http://www.wago.com/793-5501/000-005">www.wago.com/793-5501/000-005</a>
	<b>Item no.: 793-5501/000-006</b> WMB marking card; as card; stretchable 5 - 5.2 mm; plain; snap-on type; blue	<a href="http://www.wago.com/793-5501/000-006">www.wago.com/793-5501/000-006</a>

Subject to changes.



**Item no.: 793-5501/000-007**  
WMB marking card; as card; stretchable 5 - 5.2 mm; plain; snap-on type; gray

[www.wago.com/793-5501/000-007](http://www.wago.com/793-5501/000-007)



**Item no.: 793-5501/000-012**  
WMB marking card; as card; stretchable 5 - 5.2 mm; plain; snap-on type; orange

[www.wago.com/793-5501/000-012](http://www.wago.com/793-5501/000-012)



**Item no.: 793-5501/000-014**  
WMB marking card; as card; stretchable 5 - 5.2 mm; plain; snap-on type; brown

[www.wago.com/793-5501/000-014](http://www.wago.com/793-5501/000-014)



**Item no.: 793-5501/000-017**  
WMB marking card; as card; stretchable 5 - 5.2 mm; plain; snap-on type; light green

[www.wago.com/793-5501/000-017](http://www.wago.com/793-5501/000-017)



**Item no.: 793-5501/000-023**  
WMB marking card; as card; stretchable 5 - 5.2 mm; plain; snap-on type; green

[www.wago.com/793-5501/000-023](http://www.wago.com/793-5501/000-023)



**Item no.: 793-5501/000-024**  
WMB marking card; as card; stretchable 5 - 5.2 mm; plain; snap-on type; violet

[www.wago.com/793-5501/000-024](http://www.wago.com/793-5501/000-024)



**Item no.: 793-566**  
WMB marking card; as card; MARKED; 1 ... 50 (2x); not stretchable; Horizontal marking; snap-on type; white

[www.wago.com/793-566](http://www.wago.com/793-566)



**Item no.: 793-566/000-002**  
WMB marking card; as card; MARKED; 1 ... 50 (2x); not stretchable; Horizontal marking; snap-on type; yellow

[www.wago.com/793-566/000-002](http://www.wago.com/793-566/000-002)



**Item no.: 793-566/000-005**  
WMB marking card; as card; MARKED; 1 ... 50 (2x); not stretchable; Horizontal marking; snap-on type; red

[www.wago.com/793-566/000-005](http://www.wago.com/793-566/000-005)



**Item no.: 793-566/000-006**  
WMB marking card; as card; MARKED; 1 ... 50 (2x); not stretchable; Horizontal marking; snap-on type; blue

[www.wago.com/793-566/000-006](http://www.wago.com/793-566/000-006)



**Item no.: 793-566/000-007**  
WMB marking card; as card; MARKED; 1 ... 50 (2x); not stretchable; Horizontal marking; snap-on type; gray

[www.wago.com/793-566/000-007](http://www.wago.com/793-566/000-007)



**Item no.: 793-566/000-012**  
WMB marking card; as card; MARKED; 1 ... 50 (2x); not stretchable; Horizontal marking; snap-on type; orange

[www.wago.com/793-566/000-012](http://www.wago.com/793-566/000-012)



**Item no.: 793-566/000-017**  
WMB marking card; as card; MARKED; 1 ... 50 (2x); not stretchable; Horizontal marking; snap-on type; light green

[www.wago.com/793-566/000-017](http://www.wago.com/793-566/000-017)

**Item no.: 793-566/000-023**

Subject to changes.



WMB marking card; as card; MARKED; 1 ... 50 (2x); not stretchable; Horizontal marking; snap-on type; green

[www.wago.com/793-566/000-023](http://www.wago.com/793-566/000-023)



**Item no.: 793-566/000-024**

WMB marking card; as card; MARKED; 1 ... 50 (2x); not stretchable; Horizontal marking; snap-on type; violet

[www.wago.com/793-566/000-024](http://www.wago.com/793-566/000-024)

#### assembling



**Item no.: 249-116**

Screwless end stop; 6 mm wide; for DIN-rail 35 x 15 and 35 x 7.5; gray

[www.wago.com/249-116](http://www.wago.com/249-116)



**Item no.: 249-117**

Screwless end stop; 10 mm wide; for DIN-rail 35 x 15 and 35 x 7.5; gray

[www.wago.com/249-117](http://www.wago.com/249-117)



**Item no.: 249-197**

Screwless end stop; 14 mm wide; for DIN-rail 35 x 15 and 35 x 7.5; gray

[www.wago.com/249-197](http://www.wago.com/249-197)

#### power supply



**Item no.: 787-2852**

Switched-mode power supply; for JUMPFLEX® Signal Conditioners; 1-phase; 24 VDC output voltage; 1 A output current; -

[www.wago.com/787-2852](http://www.wago.com/787-2852)

## Downloads

### Documentation

#### Instruction Leaflet

JUMPFLEX®-Messumformer, Strommessumformer AC/DC 100 A	V 1.4.0	pdf 1.9 MB	Download
---	---------	---------------	----------

#### Additional Information

Disposal; Electrical and electronic equipment, Packaging	V 1.0.0	pdf 265.8 kB	Download
--	---------	-----------------	----------

2857-550, Additional Information		pdf 73.2 kB	Download
----------------------------------	--	----------------	----------

JUMPFLEX®-Messumformer, Strommessumformer AC/DC 100 A		pdf 1.5 MB	Download
---	--	---------------	----------

## Engineering-Software

### Software for Interface-Products

WAGO Interface Configuration Software SMALL	1.6.3.7	exe 48.0 MB	Download
The full setup only includes the WAGO Interface Configuration Software.	17-sep-2019		

Subject to changes.

WAGO Kontakttechnik GmbH & Co. KG

Hansastr. 27

32423 Minden

Phone: +49571 887-0 | Fax: +49571 887-169

Email: [info.de@wago.com](mailto:info.de@wago.com) | Web: [www.wago.com](http://www.wago.com)

Do you have any questions about our products?

We are always happy to take your call at +49 (571) 887-44222.

WAGO Interface Configuration Software FULL	1.6.3.7	exe	Download
The full setup, in addition to the WAGO Interface Configuration Software, includes the installation for the Microsoft .NET Framework.	17-sep-2019	98.5 MB	

## Runtime Software

### Firmware

Firmware: 2857-550 Current signal conditioner; Current input signal; Current and voltage output signal; Digital and relay output; Configuration via software; Supply voltage: 24 VDC; 22.5 mm module width	03	zip	Download
	09-may-2017	600.8 kB	

## CAD/CAE-Data

### CAD data

2D/3D Models 2857-550	URL	Download
-----------------------	-----	----------

### CAE data

EPLAN Data Portal 2857-550	Download
----------------------------	----------

WSCAD Universe 2857-550	Download
-------------------------	----------

## Installation Notes

### Configuring



Configuration via DIP switches

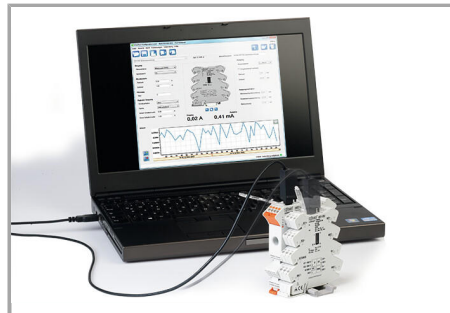

Configuration via WAGO interface configuration software

Subject to changes.

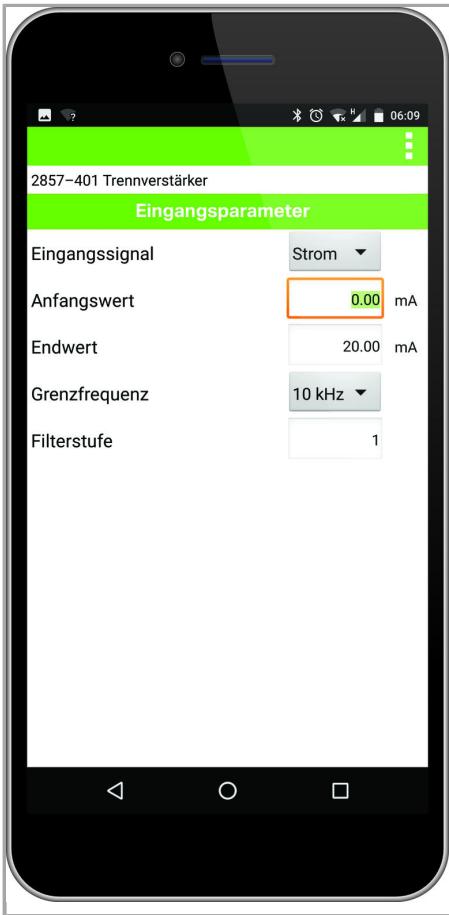

Configuration via WAGO interface configuration app



Configuration via WAGO configuration display

### Inserting a conductor

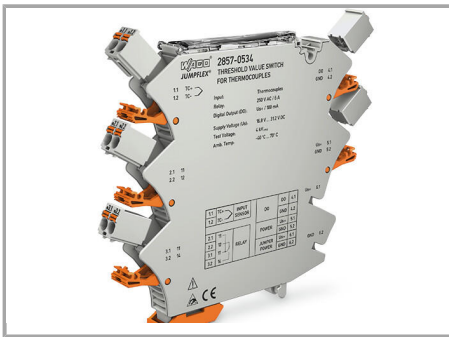

Pluggable connection technology

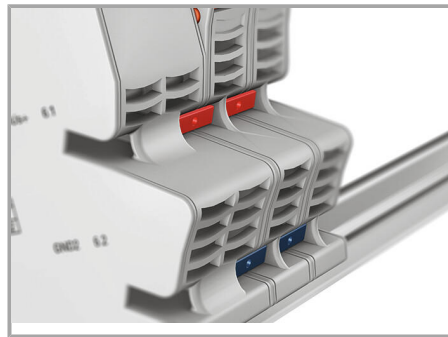

Commoning, not discrete wiring – same outline allows the use of a single in-line, push-in jumper

Subject to changes.

WAGO Kontakttechnik GmbH & Co. KG  
Hansastr. 27  
32423 Minden  
Phone: +49571 887-0 | Fax: +49571 887-169  
Email: [info.de@wago.com](mailto:info.de@wago.com) | Web: [www.wago.com](http://www.wago.com)

Do you have any questions about our products?  
We are always happy to take your call at +49 (571) 887-44222.

### Safety

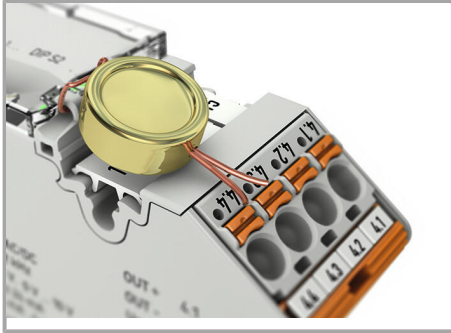

Lock-out seal option

Subject to changes.