

Data sheet | Item number: 750-453

4-channel analog input; 0 ... 20 mA; Single-ended; light gray

[www.wago.com/750-453](http://www.wago.com/750-453)

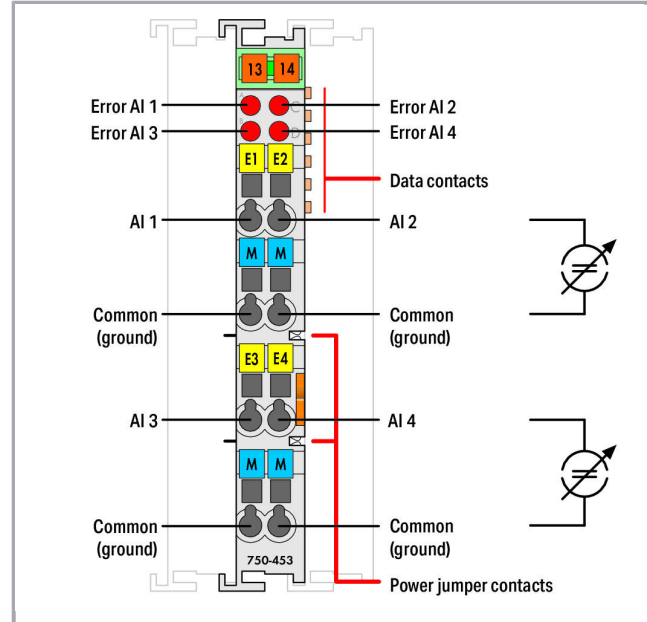
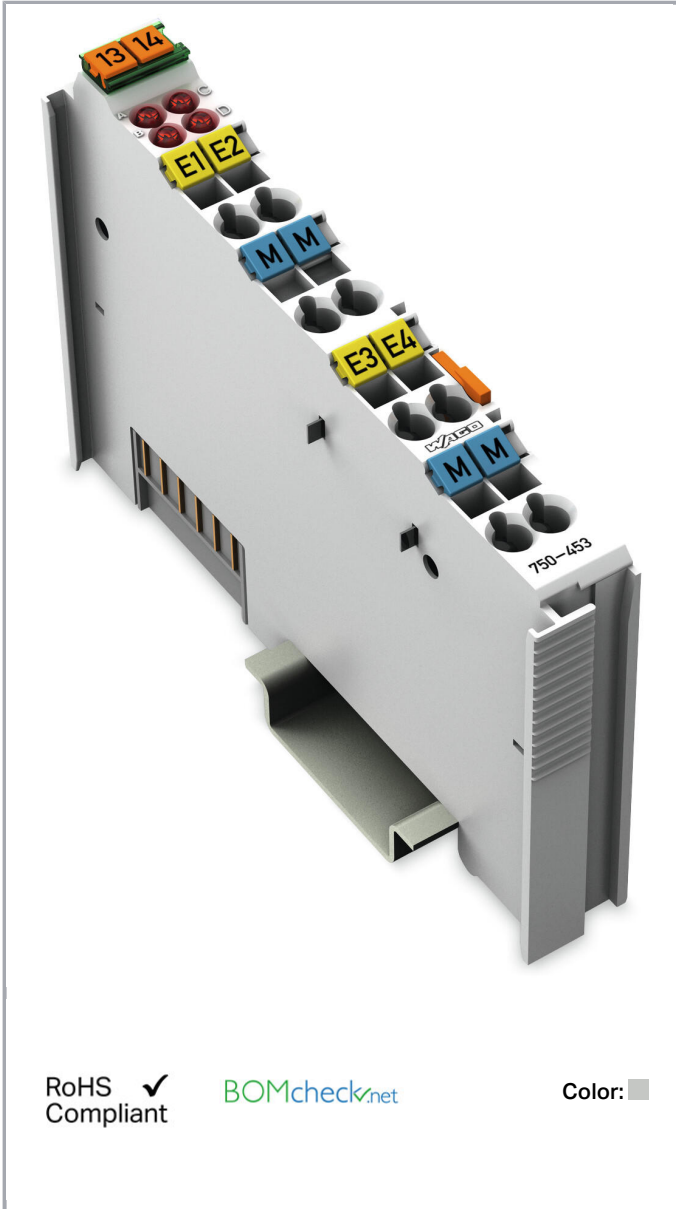

RoHS Compliant

[BOMcheck.net](https://www.bomcheck.net)

Color:

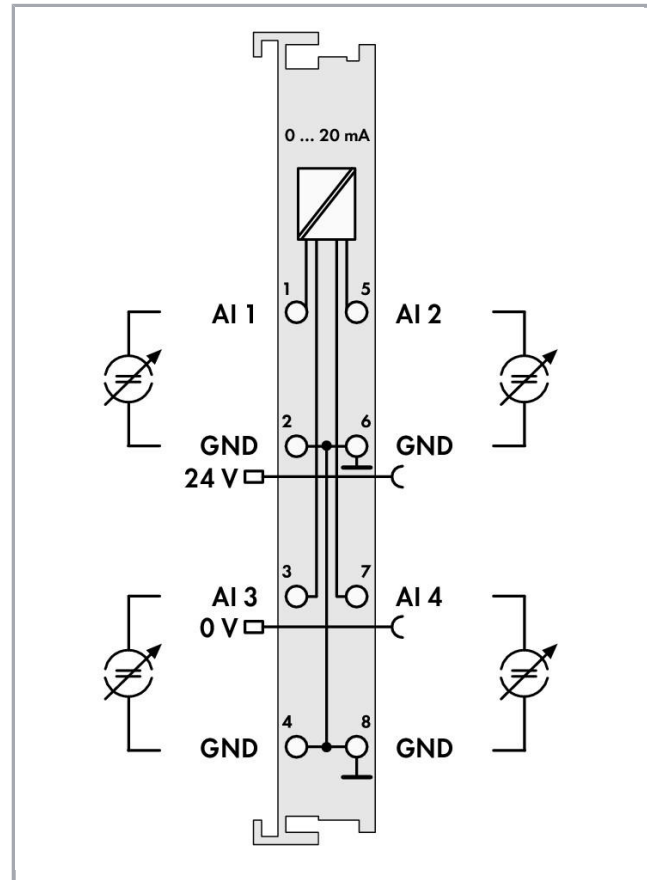
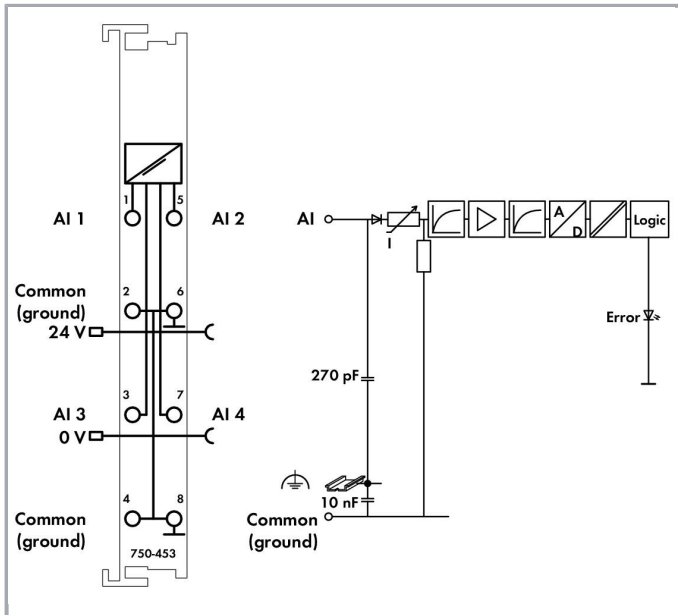

## Item description

The analog input module processes signals of a standard magnitude 0–20mA.

The input signal is electrically isolated and is transmitted with a resolution of 12 bits.

The internal system supply powers the module.

The input channels of the module have one common ground potential.

## Data

### Technical Data

Number of analog inputs	4
Total number of channels (module)	4
Type of signal	Current
Type of signal current	DC 0 ... 20 mA
Sensor connection	4 x (2-conductor)
Input voltage (max.)	32V
Signal characteristic	Single-ended
Resolution [bit]	12 Bit
Input resistance max.	100 Ω



Bit width	4 x 16-bit data; 4 x 8-bit control/status (optional)
Conversion time (typ. $\leq$ )	10 ms
Messfehler, Bezugstemperatur	25 °C
Messfehler, Abweichung max. vom Messbereichsendwert	0.1 %
Temperaturfehler max. vom Messbereichsendwert	0.01 %/K
System supply voltage	DC 5 V; via data contacts
Current consumption, system supply (5 V)	65 mA
Field supply voltage	DC 24 V (-25 ... +30 %); über Leistungskontakte (Einspeisung über Messerkontakt; Weiterleitung über Federkontakt)
Isolation	500 V system/field
Number of incoming power jumper contacts	2
Number of outgoing power jumper contacts	2
Current carrying capacity of the power jumper contacts	10 A

### Connection data

Connection technology: In-/Outputs	8 x CAGE CLAMP®
Connection type (1)	Inputs/Outputs
Solid conductor	0.08 ... 2.5 mm <sup>2</sup> / 28 ... 14 AWG
Fine-stranded conductor	0.08 ... 2.5 mm <sup>2</sup> / 28 ... 14 AWG
Strip length	8 ... 9 mm / 0.31 ... 0.35 inch

### Geometrical Data

Width	12 mm / 0.472 inch
Height	69.8 mm / 2.748 inch
Height from upper-edge of DIN-35 rail	62.6 mm / 2.465 inch
Depth	100 mm / 3.937 inch

### Mechanical data

Type of mounting	DIN-35 rail
------------------	-------------

### Material Data

Color	light gray
Housing material	Polycarbonate, polyamide 6.6
Fire load	1.237 MJ
Weight	51.226 g
Conformity marking	CE

### Environmental Requirements

Surrounding air (operating) temperature	0 ... 55 °C
Surrounding air (storage) temperature	-40 ... 85 °C



Protection class	IP20
Degree of pollution (5)	2 per IEC 61131-2
Operating altitude	0 ... 2000 m
Mounting position	horizontal (standing/lying) or vertical
Relative air humidity (no condensation)	95 %
Vibration resistance	4g per IEC 60068-2-6
Shock resistance	15g per IEC 60068-2-27
EMC immunity to interference	acc. to EN 61000-6-2, marine applications
EMC emission of interference	acc. to EN 61000-6-4, marine applications
Exposure to pollutants	Per IEC 60068-2-42 and IEC 60068-2-43
Permissible H <sub>2</sub> S contaminant concentration at a relative humidity 75 %	10 ppm
Permissible SO <sub>2</sub> contaminant concentration at a relative humidity 75 %	25 ppm

## Commercial data

Product Group	15 (Remote I/O)
Packaging type	BOX
Country of origin	DE
GTIN	4045454481902
Customs Tariff No.	85389099990

## Approvals / Certificates

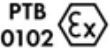
### Ex-Approvals

Logo	Approval	Additional Approval Text	Certificate name
	ATEX TUEV Nord Cert GmbH	EN 60079-0	TÜV 07 ATEX 554086 X en.
	TUEV Nord TUEV Nord Cert GmbH	IEC 60079-0	IECEx TUN 09.0001 X
	UL Underwriters Laboratories Inc. (HAZARDOUS LOCATIONS)	UL 121201	E198726 Sec.1

### Country specific Approvals

Logo	Approval	Additional Approval Text	Certificate name
	KC	Article 58-2, Clause 3	MSIP-



National Radio Research Agency

REM-W43-  
AIM750

## Ship Approvals













Logo	Approval	Additional Approval Text	Certificate name
	<b>ABS</b> American Bureau of Shipping	-	19- HG1821926
	<b>BV</b> Bureau Veritas S.A.	-	13453/DO BV
	<b>DNV GL</b> Det Norske Veritas, Germanischer Lloyd	-	TAA0000194
	<b>KR</b> Korean Register of Shipping	-	KR HMB05880- AC001
	<b>LR</b> Lloyds Register	-	02/20026 (E6)
	<b>NK</b> Nippon Kaiji Kyokai	-	TA17255M
	<b>PRS</b> Polski Rejestr Statków	-	TE/2236 /880590/19
	<b>RINA</b> RINA Germany GmbH	-	ELE066419XG

## UL-Approvals

Logo	Approval	Additional Approval Text	Certificate name
	<b>UL</b> UL International Netherlands B.V. (ORDINARY LOCATIONS)	UL 508	E175199 Sec.1

## Compatible products

### system box

	<b>Item no.: 850-804</b> IP65 enclosure; Stainless steel; WxHxD (400x123x200 mm); 4 x M20, 16 x M16, 28 x M12 cable grip	<a href="http://www.wago.com/850-804">www.wago.com/850-804</a>
	<b>Item no.: 850-804/000-001</b> IP65 enclosure; Stainless steel; WxHxD (400x123x200 mm); 2 x M20, 13 x M16, 32 x M12 cable grip	<a href="http://www.wago.com/850-804/000-001">www.wago.com/850-804/000-001</a>
	<b>Item no.: 850-805</b> IP65 enclosure; Stainless steel; WxHxD (600x123x200 mm); 4 x M20, 19 x M16, 67 x M12 cable grip	<a href="http://www.wago.com/850-805">www.wago.com/850-805</a>
	<b>Item no.: 850-814/002-000</b> IP65 enclosure; Sheet steel (RAL 7035); WxHxD (200x120x200 mm); without flange plate	<a href="http://www.wago.com/850-814/002-000">www.wago.com/850-814/002-000</a>
	<b>Item no.: 850-815/002-000</b> IP65 enclosure; Sheet steel (RAL 7035); WxHxD (300x120x200 mm); without flange plate	<a href="http://www.wago.com/850-815/002-000">www.wago.com/850-815/002-000</a>
	<b>Item no.: 850-816/002-000</b> IP65 enclosure; Sheet steel (RAL 7035); WxHxD (400x120x200 mm); without flange plate	<a href="http://www.wago.com/850-816/002-000">www.wago.com/850-816/002-000</a>
	<b>Item no.: 850-817/002-000</b> IP65 enclosure; Sheet steel (RAL 7035); WxHxD (600x120x200 mm); without flange plate	<a href="http://www.wago.com/850-817/002-000">www.wago.com/850-817/002-000</a>
	<b>Item no.: 850-825</b> IP65 enclosure; Aluminium (RAL 7032); WxHxD (160x100x160 mm); 9 x M12, 4 x M20	<a href="http://www.wago.com/850-825">www.wago.com/850-825</a>
	<b>Item no.: 850-826</b> IP65 enclosure; Aluminium (RAL 7032); WxHxD (240x100x160 mm); 4 x M20, 4 x M16, 14 x M12 cable grip	<a href="http://www.wago.com/850-826">www.wago.com/850-826</a>
	<b>Item no.: 850-826/002-000</b> IP65 enclosure; Aluminium (RAL 7035); WxHxD (240x100x160 mm); 4 x M20, 4 x M16, 14 x M12 cable grip	<a href="http://www.wago.com/850-826/002-000">www.wago.com/850-826/002-000</a>
	<b>Item no.: 850-827</b> IP65 enclosure; Aluminium (RAL 7032); WxHxD (320x100x160 mm); 4 x M20, 8 x M16, 17 x M12 cable grip	<a href="http://www.wago.com/850-827">www.wago.com/850-827</a>
	<b>Item no.: 850-827/002-000</b> IP65 enclosure; Aluminium (RAL 7035); WxHxD (320x100x160 mm); 4 x M20, 8 x M16, 17 x M12 cable grip	<a href="http://www.wago.com/850-827/002-000">www.wago.com/850-827/002-000</a>
	<b>Item no.: 850-828</b> IP65 enclosure; Aluminium (RAL 7032); WxHxD (480x100x160 mm); 4 x M20, 10 x M16, 35 x M12 cable grip	<a href="http://www.wago.com/850-828">www.wago.com/850-828</a>
	<b>Item no.: 850-828/002-000</b>	



IP65 enclosure; Aluminium (RAL 7035); WxHxD (480x100x160 mm); 4 x M20, 10 x M16, 35 x M12 cable grip

[www.wago.com/850-828/002-000](http://www.wago.com/850-828/002-000)



**Item no.: 850-834**

IP65 enclosure; Polyester (RAL 7032); WxHxD (164x100x164 mm); 9 x M12, 4 x M20

[www.wago.com/850-834](http://www.wago.com/850-834)



**Item no.: 850-835**

IP65 enclosure; Polyester (RAL 7032); WxHxD (244x100x164 mm); 4 x M20, 4 x M16, 14 x M12 cable grip

[www.wago.com/850-835](http://www.wago.com/850-835)



**Item no.: 850-836**

IP65 enclosure; Polyester (RAL 7032); WxHxD (324x100x164 mm); 4 x M20, 8 x M16, 17 x M12 cable grip

[www.wago.com/850-836](http://www.wago.com/850-836)

**Marking accessories**



**Item no.: 2009-145**

Mini-WSB Inline; for Smart Printer; on reel; stretchable 5 - 5.2 mm; plain; snap-on type; white

[www.wago.com/2009-145](http://www.wago.com/2009-145)



**Item no.: 2009-145/000-002**

Mini-WSB Inline; for Smart Printer; on reel; stretchable 5 - 5.2 mm; plain; snap-on type; yellow

[www.wago.com/2009-145/000-002](http://www.wago.com/2009-145/000-002)



**Item no.: 2009-145/000-005**

Mini-WSB Inline; for Smart Printer; on reel; stretchable 5 - 5.2 mm; plain; snap-on type; red

[www.wago.com/2009-145/000-005](http://www.wago.com/2009-145/000-005)



**Item no.: 2009-145/000-006**

Mini-WSB Inline; for Smart Printer; on reel; stretchable 5 - 5.2 mm; plain; snap-on type; blue

[www.wago.com/2009-145/000-006](http://www.wago.com/2009-145/000-006)



**Item no.: 2009-145/000-007**

Mini-WSB Inline; for Smart Printer; on reel; stretchable 5 - 5.2 mm; plain; snap-on type; gray

[www.wago.com/2009-145/000-007](http://www.wago.com/2009-145/000-007)



**Item no.: 2009-145/000-012**

Mini-WSB Inline; for Smart Printer; on reel; stretchable 5 - 5.2 mm; plain; snap-on type; orange

[www.wago.com/2009-145/000-012](http://www.wago.com/2009-145/000-012)



**Item no.: 2009-145/000-023**

Mini-WSB Inline; for Smart Printer; on reel; stretchable 5 - 5.2 mm; plain; snap-on type; green

[www.wago.com/2009-145/000-023](http://www.wago.com/2009-145/000-023)



**Item no.: 2009-145/000-024**

Mini-WSB Inline; for Smart Printer; on reel; stretchable 5 - 5.2 mm; plain; snap-on type; violet

[www.wago.com/2009-145/000-024](http://www.wago.com/2009-145/000-024)



**Item no.: 248-501**

Miniature WSB Quick marking system; plain; Marker width 5 mm; 10 strips with 10 markers per card

[www.wago.com/248-501](http://www.wago.com/248-501)



**Item no.: 248-501/000-002**

Mini-WSB marking card; as card; not stretchable; plain; snap-on type; yellow

[www.wago.com/248-501/000-002](http://www.wago.com/248-501/000-002)



**Item no.: 248-501/000-005**

Mini-WSB marking card; as card; not stretchable; plain; snap-on type; red

[www.wago.com/248-501/000-005](http://www.wago.com/248-501/000-005)

**Item no.: 248-501/000-006**

Mini-WSB marking card; as card; not stretchable; plain; snap-on type; blue

[www.wago.com/248-501/000-006](http://www.wago.com/248-501/000-006)



**Item no.: 248-501/000-007**

Mini-WSB marking card; as card; not stretchable; plain; snap-on type; gray

[www.wago.com/248-501/000-007](http://www.wago.com/248-501/000-007)



**Item no.: 248-501/000-012**

Mini-WSB marking card; as card; not stretchable; plain; snap-on type; orange

[www.wago.com/248-501/000-012](http://www.wago.com/248-501/000-012)



**Item no.: 248-501/000-017**

Mini-WSB marking card; as card; not stretchable; plain; snap-on type; light green

[www.wago.com/248-501/000-017](http://www.wago.com/248-501/000-017)



**Item no.: 248-501/000-023**

Mini-WSB marking card; as card; not stretchable; plain; snap-on type; green

[www.wago.com/248-501/000-023](http://www.wago.com/248-501/000-023)



**Item no.: 248-501/000-024**

Mini-WSB marking card; as card; not stretchable; plain; snap-on type; violet

[www.wago.com/248-501/000-024](http://www.wago.com/248-501/000-024)



**Item no.: 750-100**

Marker card; as a DIN A4 sheet; plain; white

[www.wago.com/750-100](http://www.wago.com/750-100)



**Item no.: 750-103**

Group marker carrier

[www.wago.com/750-103](http://www.wago.com/750-103)



**Item no.: 750-106**

Group marker carrier

[www.wago.com/750-106](http://www.wago.com/750-106)

**Carrier rail**



**Item no.: 210-112**

Steel carrier rail; 35 x 7.5 mm; 1 mm thick; 2 m long; slotted; according to EN 60715; "Hole width 25 mm

[www.wago.com/210-112](http://www.wago.com/210-112)



**Item no.: 210-113**

Steel carrier rail; 35 x 7.5 mm; 1 mm thick; 2 m long; unslotted; according to EN 60715

[www.wago.com/210-113](http://www.wago.com/210-113)



**Item no.: 210-114**

Steel carrier rail; 35 x 15 mm; 1.5 mm thick; 2 m long; unslotted; similar to EN 60715

[www.wago.com/210-114](http://www.wago.com/210-114)



**Item no.: 210-115**

Steel carrier rail; 35 x 7.5 mm; 1 mm thick; 2 m long; slotted; according to EN 60715; "Hole width 18 mm

[www.wago.com/210-115](http://www.wago.com/210-115)



**Item no.: 210-118**

Steel carrier rail; 35 x 15 mm; 2.3 mm thick; 2 m long; unslotted; according to EN 60715

[www.wago.com/210-118](http://www.wago.com/210-118)



**Item no.: 210-196**

Aluminum carrier rail; 35 x 8.2 mm; 1.6 mm thick; 2 m long; unslotted; similar to EN 60715; silver-colored

[www.wago.com/210-196](http://www.wago.com/210-196)



**Item no.: 210-197**

Steel carrier rail; 35 x 15 mm; 1.5 mm thick; 2 m long; slotted; similar to EN 60715

[www.wago.com/210-197](http://www.wago.com/210-197)













**Item no.: 210-198**

Copper carrier rail; 35 x 15 mm; 2.3 mm thick; 2 m long; unslotted; according to EN 60715; copper-colored

[www.wago.com/210-198](http://www.wago.com/210-198)



	<b>Item no.: 210-504</b> Steel carrier rail; 35 x 7.5 mm; 1 mm thick; 2 m long; slotted; galvanized; according to EN 60715	<a href="http://www.wago.com/210-504">www.wago.com/210-504</a>
	<b>Item no.: 210-505</b> Steel carrier rail; 35 x 7.5 mm; 1 mm thick; 2 m long; unslotted; galvanized; according to EN 60715	<a href="http://www.wago.com/210-505">www.wago.com/210-505</a>
	<b>Item no.: 210-506</b> Steel carrier rail; 35 x 15 mm; 1.5 mm thick; 2 m long; unslotted; galvanized; similar to EN 60715	<a href="http://www.wago.com/210-506">www.wago.com/210-506</a>
	<b>Item no.: 210-508</b> Steel carrier rail; 35 x 15 mm; 1.5 mm thick; 2 m long; slotted; galvanized; similar to EN 60715	<a href="http://www.wago.com/210-508">www.wago.com/210-508</a>
<b>shield connection</b>		
	<b>Item no.: 790-108</b> Shield clamping saddle; 11 mm wide; diameter of compatible conductor	<a href="http://www.wago.com/790-108">www.wago.com/790-108</a>
	<b>Item no.: 790-116</b> Shield clamping saddle; 19 mm wide; diameter of compatible conductor; 7 ... 16 mm	<a href="http://www.wago.com/790-116">www.wago.com/790-116</a>
	<b>Item no.: 790-124</b> Shield clamping saddle; 27 mm wide; diameter of compatible conductor; 6 ... 24 mm	<a href="http://www.wago.com/790-124">www.wago.com/790-124</a>
	<b>Item no.: 790-140</b> Shield clamping saddle; diameter of compatible conductor	<a href="http://www.wago.com/790-140">www.wago.com/790-140</a>
	<b>Item no.: 790-208</b> Shield clamping saddle; 12.4 mm wide; 3 ... 8 mm	<a href="http://www.wago.com/790-208">www.wago.com/790-208</a>
	<b>Item no.: 790-216</b> Shield clamping saddle; 21.8 mm wide; 6 ... 16 mm	<a href="http://www.wago.com/790-216">www.wago.com/790-216</a>
	<b>Item no.: 790-220</b> Shield clamping saddle; 30 mm wide; 6 ... 20 mm	<a href="http://www.wago.com/790-220">www.wago.com/790-220</a>

## Downloads

### Documentation

#### Manual

4-channel, 0-20mA, single-ended	V 1.1.1	pdf 2.0 MB	Download
---------------------------------	---------	---------------	----------

#### Additional Information

Disposal; Electrical and electronic equipment, Packaging	V 1.0.0	pdf 265.8 kB	Download
--	---------	-----------------	----------

#### System Description

750/753 Series I/O-System – General Product Information		pdf 1.7 MB	Download
---	--	---------------	----------

Overview on WAGO-I/O-SYSTEM 750 approvals		pdf 780.2 kB	Download
---	--	-----------------	----------

#### Use in Hazardous Environments



Term definition, marking and installation regulations	V 1.0.0	pdf 1.0 MB	Download
Design Notes Basic conditions and recommendations for higher operational safety	V 2.0.0	pdf 1.5 MB	Download

## CAD/CAE-Data

### CAD data

2D/3D Models 750-453		URL	Download
----------------------	--	-----	----------

### CAE data

EPLAN Data Portal 750-453			Download
WSCAD Universe 750-453			Download

## Device Files

### Device Driver

WAGO USB Service Kabel Treiber / Serie 750 und 857	6.5.3.0 2014-09-10	zip 4.8 MB	Download
--	-----------------------	---------------	----------

## Installation Notes

## Product family

**750/753 Series – I/O System**  
[Show all products from the family](#)

Subject to changes.