

Data sheet | Item number: 750-457

4-channel analog input; ± 10 VDC; Single-ended; light gray

www.wago.com/750-457

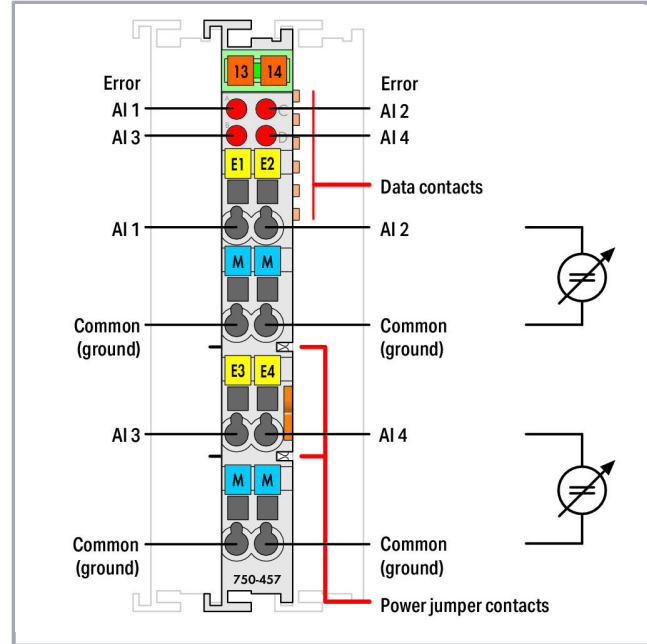

RoHS Compliant

[BOMcheck.net](https://www.bomcheck.net)

Color:

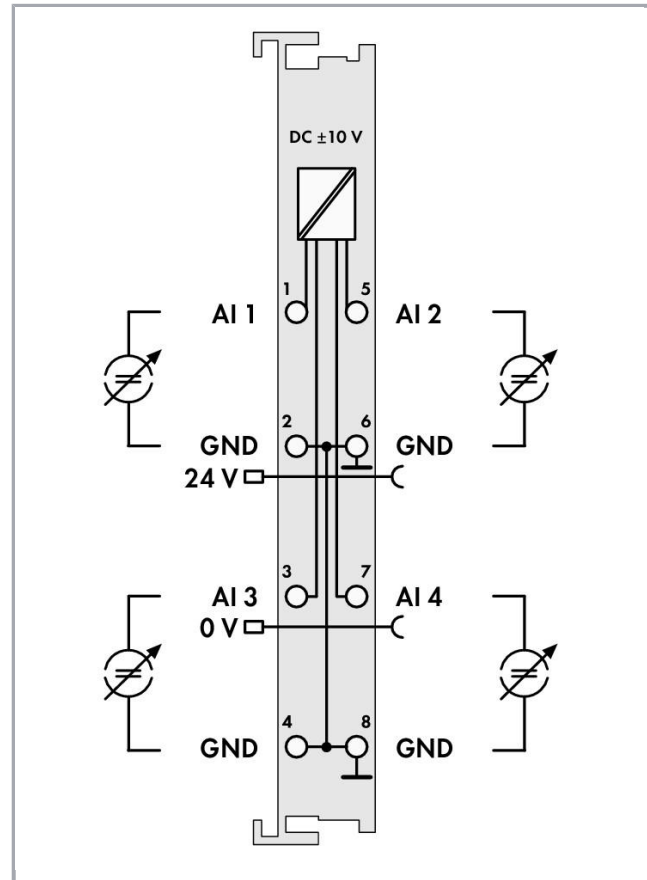
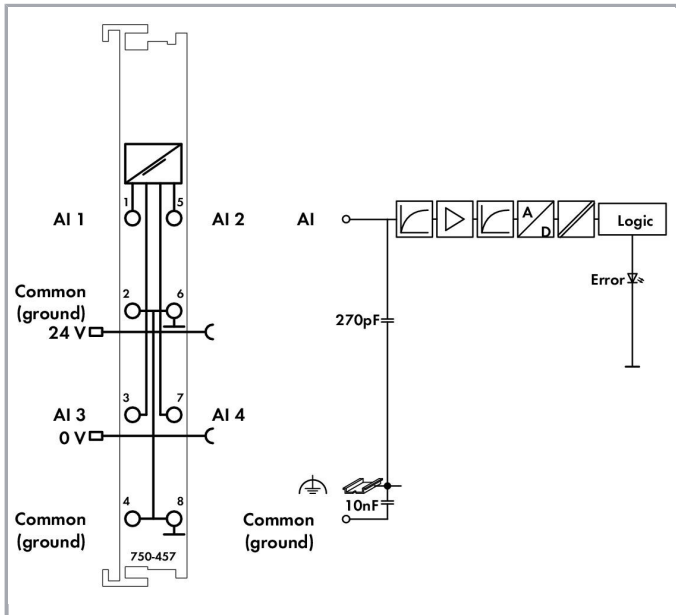

Item description

The analog input module processes signals of a standard magnitude $\pm 10V$.

The input signal is electrically isolated and is transmitted with a resolution of 12 bits.

The internal system supply powers the module.

The input channels of the module have one common ground potential.

Data

Technical Data

Number of analog inputs	4
Total number of channels (module)	4
Type of signal	Voltage
Type of signal voltage	DC -10 ... +10 V
Sensor connection	4 x (2-conductor)
Input voltage (max.)	$\pm 40 V$
Signal characteristic	Single-ended
Resolution [bit]	12 Bit
Bit width	4 x 16-bit data; 4 x 8-bit control/status (optional)



Internal resistance	100 kΩ
Conversion time (typ. ≤)	10 ms
Messfehler, Bezugstemperatur	25 °C
Messfehler, Abweichung max. vom Messbereichsendwert	0.1 %
Temperaturfehler max. vom Messbereichsendwert	0.01 %/K
System supply voltage	DC 5 V; via data contacts
Current consumption, system supply (5 V)	65 mA
Field supply voltage	DC 24 V (-25 ... +30 %); über Leistungskontakte (Einspeisung über Messerkontakt; Weiterleitung über Federkontakt)
Isolation	500 V system/supply
Number of incoming power jumper contacts	2
Number of outgoing power jumper contacts	2
Current carrying capacity of the power jumper contacts	10 A

Connection data

Connection technology: In-/Outputs	8 x CAGE CLAMP®
Connection type (1)	Inputs/Outputs
Solid conductor	0.08 ... 2.5 mm ² / 28 ... 14 AWG
Fine-stranded conductor	0.08 ... 2.5 mm ² / 28 ... 14 AWG
Strip length	8 ... 9 mm / 0.31 ... 0.35 inch

Geometrical Data

Width	12 mm / 0.472 inch
Height	69.8 mm / 2.748 inch
Height from upper-edge of DIN-35 rail	62.6 mm / 2.465 inch
Depth	100 mm / 3.937 inch

Mechanical data

Type of mounting	DIN-35 rail
------------------	-------------

Material Data

Color	light gray
Housing material	Polycarbonate, polyamide 6.6
Fire load	1.499 MJ
Weight	50.7 g
Conformity marking	CE

Environmental Requirements

Surrounding air (operating) temperature	0 ... 55 °C
Surrounding air (storage) temperature	-40 ... 85 °C



Protection class	IP20
Degree of pollution (5)	2 per IEC 61131-2
Operating altitude	0 ... 2000 m
Mounting position	horizontal (standing/lying) or vertical
Relative air humidity (no condensation)	95 %
Vibration resistance	4g per IEC 60068-2-6
Shock resistance	15g per IEC 60068-2-27
EMC immunity to interference	acc. to EN 61000-6-2, marine applications
EMC emission of interference	acc. to EN 61000-6-4, marine applications
Exposure to pollutants	Per IEC 60068-2-42 and IEC 60068-2-43
Permissible H ₂ S contaminant concentration at a relative humidity 75 %	10 ppm
Permissible SO ₂ contaminant concentration at a relative humidity 75 %	25 ppm

Commercial data

Product Group	15 (Remote I/O)
Packaging type	BOX
Country of origin	DE
GTIN	4045454485375
Customs Tariff No.	85389099990

Approvals / Certificates

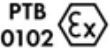
Ex-Approvals

Logo	Approval	Additional Approval Text	Certificate name
	ATEX TUEV Nord Cert GmbH	EN 60079-0	TÜV 07 ATEX 554086 X en.
	TUEV Nord TUEV Nord Cert GmbH	IEC 60079-0	IECEX TUN 09.0001 X
	UL Underwriters Laboratories Inc. (HAZARDOUS LOCATIONS)	UL 121201	E198726 Sec.1

Country specific Approvals

Logo	Approval	Additional Approval Text	Certificate name
	KC	Article 58-2, Clause 3	MSIP-



National Radio Research Agency

REM-W43-
AIM750

Ship Approvals







Logo	Approval	Additional Approval Text	Certificate name
	ABS American Bureau of Shipping	-	19- HG1821926
	BV Bureau Veritas S.A.	-	13453/DO BV
	DNV GL Det Norske Veritas, Germanischer Lloyd	-	TAA0000194
	KR Korean Register of Shipping	-	KR HMB05880- AC001
	LR Lloyds Register	-	02/20026 (E6)
	NK Nippon Kaiji Kyokai	-	TA17255M
	PRS Polski Rejestr Statków	-	TE/2236 /880590/19
	RINA RINA Germany GmbH	-	ELE066419XG

UL-Approvals

Logo	Approval	Additional Approval Text	Certificate name
	UL UL International Netherlands B.V. (ORDINARY LOCATIONS)	UL 508	E175199 Sec.1

















Compatible products

shield connection

	Item no.: 790-108 Shield clamping saddle; 11 mm wide; diameter of compatible conductor; 3 ... 8 mm	www.wago.com/790-108
	Item no.: 790-116 Shield clamping saddle; 19 mm wide; diameter of compatible conductor; 7 ... 16 mm	www.wago.com/790-116
	Item no.: 790-124 Shield clamping saddle; 27 mm wide; diameter of compatible conductor; 6 ... 24 mm	www.wago.com/790-124
	Item no.: 790-140 Shield clamping saddle; diameter of compatible conductor	www.wago.com/790-140
	Item no.: 790-208 Shield clamping saddle; 12.4 mm wide; 3 ... 8 mm	www.wago.com/790-208
	Item no.: 790-216 Shield clamping saddle; 21.8 mm wide; 6 ... 16 mm	www.wago.com/790-216
	Item no.: 790-220 Shield clamping saddle; 30 mm wide; 6 ... 20 mm	www.wago.com/790-220

Carrier rail

	Item no.: 210-112 Steel carrier rail; 35 x 7.5 mm; 1 mm thick; 2 m long; slotted; according to EN 60715; "Hole width 25 mm	www.wago.com/210-112
	Item no.: 210-113 Steel carrier rail; 35 x 7.5 mm; 1 mm thick; 2 m long; unslotted; according to EN 60715	www.wago.com/210-113
	Item no.: 210-114 Steel carrier rail; 35 x 15 mm; 1.5 mm thick; 2 m long; unslotted; similar to EN 60715	www.wago.com/210-114
	Item no.: 210-115 Steel carrier rail; 35 x 7.5 mm; 1 mm thick; 2 m long; slotted; according to EN 60715; "Hole width 18 mm	www.wago.com/210-115
	Item no.: 210-118 Steel carrier rail; 35 x 15 mm; 2.3 mm thick; 2 m long; unslotted; according to EN 60715	www.wago.com/210-118
	Item no.: 210-196 Aluminum carrier rail; 35 x 8.2 mm; 1.6 mm thick; 2 m long; unslotted; similar to EN 60715; silver-colored	www.wago.com/210-196
	Item no.: 210-197 Steel carrier rail; 35 x 15 mm; 1.5 mm thick; 2 m long; slotted; similar to EN 60715	www.wago.com/210-197
	Item no.: 210-198 Copper carrier rail; 35 x 15 mm; 2.3 mm thick; 2 m long; unslotted; according to EN 60715; copper-colored	www.wago.com/210-198
	Item no.: 210-504 Steel carrier rail; 35 x 7.5 mm; 1 mm thick; 2 m long; slotted; galvanized; according to EN 60715	www.wago.com/210-504

	Item no.: 210-505 Steel carrier rail; 35 x 7.5 mm; 1 mm thick; 2 m long; unslotted; galvanized; according to EN 60715	www.wago.com/210-505
	Item no.: 210-506 Steel carrier rail; 35 x 15 mm; 1.5 mm thick; 2 m long; unslotted; galvanized; similar to EN 60715	www.wago.com/210-506
	Item no.: 210-508 Steel carrier rail; 35 x 15 mm; 1.5 mm thick; 2 m long; slotted; galvanized; similar to EN 60715	www.wago.com/210-508
system box		
	Item no.: 850-804 IP65 enclosure; Stainless steel; WxHxD (400x123x200 mm); 4 x M20, 16 x M16, 28 x M12 cable grip	www.wago.com/850-804
	Item no.: 850-804/000-001 IP65 enclosure; Stainless steel; WxHxD (400x123x200 mm); 2 x M20, 13 x M16, 32 x M12 cable grip	www.wago.com/850-804/000-001
	Item no.: 850-805 IP65 enclosure; Stainless steel; WxHxD (600x123x200 mm); 4 x M20, 19 x M16, 67 x M12 cable grip	www.wago.com/850-805
	Item no.: 850-814/002-000 IP65 enclosure; Sheet steel (RAL 7035); WxHxD (200x120x200 mm); without flange plate	www.wago.com/850-814/002-000
	Item no.: 850-815/002-000 IP65 enclosure; Sheet steel (RAL 7035); WxHxD (300x120x200 mm); without flange plate	www.wago.com/850-815/002-000
	Item no.: 850-816/002-000 IP65 enclosure; Sheet steel (RAL 7035); WxHxD (400x120x200 mm); without flange plate	www.wago.com/850-816/002-000
	Item no.: 850-817/002-000 IP65 enclosure; Sheet steel (RAL 7035); WxHxD (600x120x200 mm); without flange plate	www.wago.com/850-817/002-000
	Item no.: 850-825 IP65 enclosure; Aluminium (RAL 7032); WxHxD (160x100x160 mm); 9 x M12, 4 x M20	www.wago.com/850-825
	Item no.: 850-826 IP65 enclosure; Aluminium (RAL 7032); WxHxD (240x100x160 mm); 4 x M20, 4 x M16, 14 x M12 cable grip	www.wago.com/850-826
	Item no.: 850-826/002-000 IP65 enclosure; Aluminium (RAL 7035); WxHxD (240x100x160 mm); 4 x M20, 4 x M16, 14 x M12 cable grip	www.wago.com/850-826/002-000
	Item no.: 850-827 IP65 enclosure; Aluminium (RAL 7032); WxHxD (320x100x160 mm); 4 x M20, 8 x M16, 17 x M12 cable grip	www.wago.com/850-827
	Item no.: 850-827/002-000 IP65 enclosure; Aluminium (RAL 7035); WxHxD (320x100x160 mm); 4 x M20, 8 x M16, 17 x M12 cable grip	www.wago.com/850-827/002-000
	Item no.: 850-828 IP65 enclosure; Aluminium (RAL 7032); WxHxD (480x100x160 mm); 4 x M20, 10 x M16, 35 x M12 cable grip	www.wago.com/850-828
	Item no.: 850-828/002-000	



IP65 enclosure; Aluminium (RAL 7035); WxHxD (480x100x160 mm); 4 x M20, 10 x M16, 35 x M12 cable grip

www.wago.com/850-828/002-000



Item no.: 850-834
IP65 enclosure; Polyester (RAL 7032); WxHxD (164x100x164 mm); 9 x M12, 4 x M20

www.wago.com/850-834



Item no.: 850-835
IP65 enclosure; Polyester (RAL 7032); WxHxD (244x100x164 mm); 4 x M20, 4 x M16, 14 x M12 cable grip

www.wago.com/850-835



Item no.: 850-836
IP65 enclosure; Polyester (RAL 7032); WxHxD (324x100x164 mm); 4 x M20, 8 x M16, 17 x M12 cable grip

www.wago.com/850-836

Marking accessories



Item no.: 2009-145
Mini-WSB Inline; for Smart Printer; on reel; stretchable 5 - 5.2 mm; plain; snap-on type; white

www.wago.com/2009-145



Item no.: 2009-145/000-002
Mini-WSB Inline; for Smart Printer; on reel; stretchable 5 - 5.2 mm; plain; snap-on type; yellow

www.wago.com/2009-145/000-002



Item no.: 2009-145/000-005
Mini-WSB Inline; for Smart Printer; on reel; stretchable 5 - 5.2 mm; plain; snap-on type; red

www.wago.com/2009-145/000-005



Item no.: 2009-145/000-006
Mini-WSB Inline; for Smart Printer; on reel; stretchable 5 - 5.2 mm; plain; snap-on type; blue

www.wago.com/2009-145/000-006



Item no.: 2009-145/000-007
Mini-WSB Inline; for Smart Printer; on reel; stretchable 5 - 5.2 mm; plain; snap-on type; gray

www.wago.com/2009-145/000-007



Item no.: 2009-145/000-012
Mini-WSB Inline; for Smart Printer; on reel; stretchable 5 - 5.2 mm; plain; snap-on type; orange

www.wago.com/2009-145/000-012



Item no.: 2009-145/000-023
Mini-WSB Inline; for Smart Printer; on reel; stretchable 5 - 5.2 mm; plain; snap-on type; green

www.wago.com/2009-145/000-023



Item no.: 2009-145/000-024
Mini-WSB Inline; for Smart Printer; on reel; stretchable 5 - 5.2 mm; plain; snap-on type; violet

www.wago.com/2009-145/000-024



Item no.: 248-501
Miniature WSB Quick marking system; plain; Marker width 5 mm; 10 strips with 10 markers per card

www.wago.com/248-501



Item no.: 248-501/000-002
Mini-WSB marking card; as card; not stretchable; plain; snap-on type; yellow

www.wago.com/248-501/000-002



Item no.: 248-501/000-005
Mini-WSB marking card; as card; not stretchable; plain; snap-on type; red

www.wago.com/248-501/000-005



Item no.: 248-501/000-006
Mini-WSB marking card; as card; not stretchable; plain; snap-on type; blue

www.wago.com/248-501/000-006



Item no.: 248-501/000-007
Mini-WSB marking card; as card; not stretchable; plain; snap-on type; gray

www.wago.com/248-501/000-007



Item no.: 248-501/000-012
Mini-WSB marking card; as card; not stretchable; plain; snap-on type; orange

www.wago.com/248-501/000-012



Item no.: 248-501/000-017
Mini-WSB marking card; as card; not stretchable; plain; snap-on type; light green

www.wago.com/248-501/000-017



Item no.: 248-501/000-023
Mini-WSB marking card; as card; not stretchable; plain; snap-on type; green

www.wago.com/248-501/000-023



Item no.: 248-501/000-024
Mini-WSB marking card; as card; not stretchable; plain; snap-on type; violet

www.wago.com/248-501/000-024



Item no.: 750-100
Marker card; as a DIN A4 sheet; plain; white

www.wago.com/750-100



Item no.: 750-103
Group marker carrier

www.wago.com/750-103



Item no.: 750-106
Group marker carrier

www.wago.com/750-106

Downloads

Documentation

Manual

4-channel, ± 10VDC, single ended	V 1.2.0	pdf 2.1 MB	Download
----------------------------------	---------	---------------	----------

Additional Information

Disposal; Electrical and electronic equipment, Packaging	V 1.0.0	pdf 265.8 kB	Download
--	---------	-----------------	----------

System Description

Design Notes Basic conditions and recommendations for higher operational safety	V 2.0.0	pdf 1.5 MB	Download
--	---------	---------------	----------

750/753 Series I/O-System – General Product Information		pdf 1.7 MB	Download
---	--	---------------	----------

Overview on WAGO-I/O-SYSTEM 750 approvals



pdf
780.2 kB

Download

Use in Hazardous Environments Term definition, marking and installation regulations	V 1.0.0	pdf 1.0 MB	Download
--	---------	---------------	----------

CAD/CAE-Data

CAD data

2D/3D Models 750-457		URL	Download
----------------------	--	-----	----------

CAE data

EPLAN Data Portal 750-457			Download
---------------------------	--	--	----------

WSCAD Universe 750-457			Download
------------------------	--	--	----------

Device Files

Device Driver

WAGO USB Service Kabel Treiber / Serie 750 und 857	6.5.3.0 10-sep-2014	zip 4.8 MB	Download
--	------------------------	---------------	----------

Installation Notes

Product family

750/753 Series – I/O System

[Show all products from the family](#)

Subject to changes.