

Data sheet | Item number: 857-800

Temperature signal conditioner for RTD sensors; Current and voltage output signal; Configuration via DIP switch; Supply voltage: 24 VDC; 6 mm module width

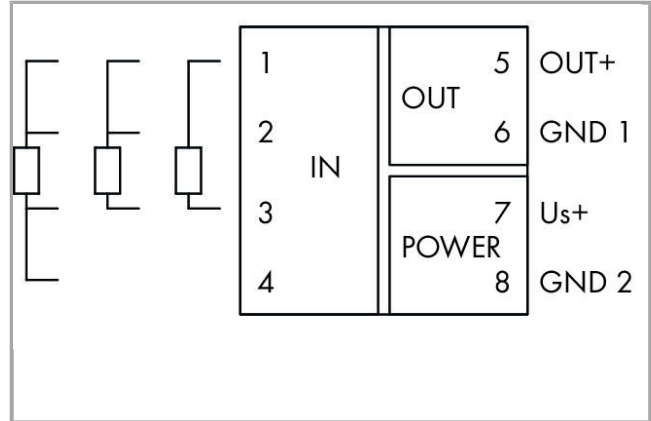

[www.wago.com/857-800](http://www.wago.com/857-800)

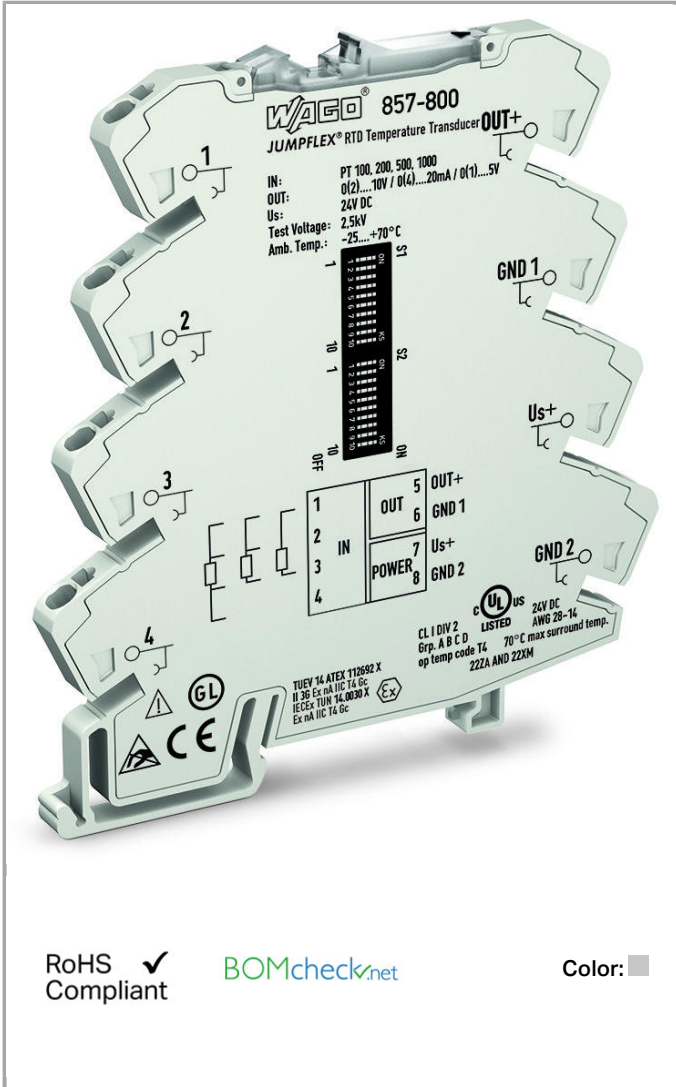

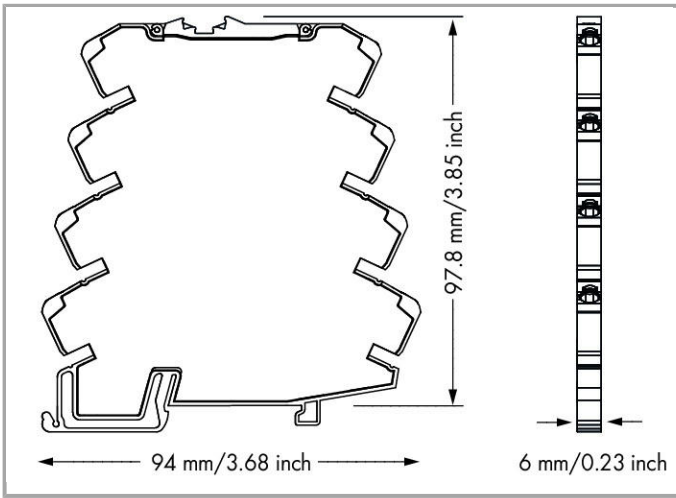

857-800  
DIP Switch Adjustability

• = ON    Default

DIP Switch S1				Measurement Range Underflow		Measurement Range Overflow		Wire Break		Short Circuit	
Wire Connection	Sensor Type	Output Signal		9	10	9	10	9	10	9	10
2-LEADER	Pt100	0...20 mA				Lower limit of output range -5 %*	Upper limit of output range +2.5 %*	Upper limit of output range +5 %*	Lower limit of output range -2.5 %*		
3-LEADER	Pt200	4...20 mA									
4-LEADER	Pt500	0...10 mA				Lower limit of output range	Upper limit of output range + 2.5 %	Upper limit of output range + 5 %	Lower limit of output range		
	Pt1000	2...10 mA				Lower limit of output range	Upper limit of output range	Upper limit of output range + 5 %	Lower limit of output range		
	1 kΩ	0...10 V				Lower limit of output range	Upper limit of output range	Upper limit of output range + 5 %	Lower limit of output range		
	4.5 kΩ	2...10 V				Lower limit of output range	Upper limit of output range	Upper limit of output range + 5 %	Lower limit of output range		
		0...5 V				Lower limit of output range	Upper limit of output range	Upper limit of output range	Lower limit of output range		
		1...5 V				Lower limit of output range	Upper limit of output range	Upper limit of output range	Lower limit of output range		

\* acc. to NAMUR NE 43

DIP Switch S2																																	
Start Temperature						End Temperature																											
1	2	3	4	°C	°F	5	6	7	8	9	10	°C	°F	5	6	7	8	9	10	°C	°F												
				0	32							100	212							75	167					210	410					475	887
				-200	-328							0	32							80	176					220	428					500	932
				-175	-283							5	41							85	185					230	446					525	997
				-150	-238							10	50							90	194					240	464					550	1022
				-125	-193							15	59							95	203					250	482					575	1067
				-100	-148							20	68							100	212					260	500					600	1112
				-90	-130							25	77							110	230					270	518					625	1157
				-80	-112							30	86							120	248					280	536					650	1202
				-70	-94							35	95							130	266					290	554					675	1247
				-60	-76							40	104							140	284					300	572					700	1292
				-50	-58							45	113							150	302					325	617					725	1337
				-40	-40							50	122							160	320					350	662					750	1382
				-30	-22							55	131							170	338					375	707					775	1427
				-20	-4							60	140							180	356					400	752					800	1472
				-10	14							65	149							190	374					425	797					825	1517
				0	32							70	158							200	392					450	842					850	1562

The minimum distance from the start temperature to the end temperature may not fall short of 50K degrees on the Celsius (C) scale or 122K degrees on the Fahrenheit (F) scale.

### Item description

#### Short description:

This temperature signal conditioner records Pt100, Pt200, Pt500, and Pt1000 Sensors, as well as resistors up to 4.5 kOhm, converting the temperature signal into a standard analog signal on the output side.

#### Features:

- For Pt100, Pt200, Pt500 and Pt1000 sensors, as well as resistors up to 4.5 kOhm
- 2-, 3-, and 4-wire connection technology.
- Switching between measurement ranges is calibrated
- Detect wire break/sensor short circuit
- Detect measurement range underflow/measurement range overflow
- Integrate a switchable clipping function to limit the standard analog signal to the upper range values
- Safe 3-way isolation with 2.5 kV test voltage per EN 61140

### Data

#### Technical Data

#### Configuration

Configuration options

DIP switches

#### Input

Input signal type

Pt sensors

Resistance

#### Input – RTD sensors

Sensor types (RTD)

Pt100

Pt200



	Pt500 Pt1000
Sensor connection	2-wire; 3-wire; 4-wire (switchable)
Max. sensor supply current (RTD)	≤ 0.5 mA
Measurement range temperature (RTD)	-200 ... 850°C

### Input – Resistors

Input range resistance	0 ... 1 kΩ; 0 ... 4.5 kΩ
------------------------	--------------------------

### Output

Output signal type	Current Voltage
Output signal voltage	0 ... 5 V; 1 ... 5 V; 0 ... 10 V; 2 ... 10 V
Output signal current	0 ... 10 mA; 2 ... 10 mA; 0 ... 20 mA; 4 ... 20 mA
Load impedance (output/voltage)	≥ 2 kΩ
Load impedance (output/current)	≤ 600 Ω

### Signal processing

Step response typ.	180 ms (2-wire); 360 ms (3-wire)
--------------------	----------------------------------

### Measurement error

Transmission error typ.	≤ 0.1 % at max. measuring span
Transmission error of set measurement range	≤ ((10 K/set measurement range [K]) + 0,1) %
Temperature coefficient	≤ 0.02 %/K

### Power supply

Type of power supply	24 VDC
Nominal supply voltage $U_S$	DC 24 V
Supply voltage range	±30 %
Current consumption at supply voltage	≤ 40 mA

### Safety and protection:

Test voltage (input/output/supply)	AC 2.5 kV; 50 Hz; 1 min
Protection class	IP20

### Connection data

Connection technology	Push-in CAGE CLAMP®
Solid conductor	0.08 ... 2.5 mm <sup>2</sup> / 28 ... 14 AWG
Fine-stranded conductor	0.34 ... 2.5 mm <sup>2</sup> / 22 ... 14 AWG

Strip length	9 ... 10 mm / 0.35 ... 0.39 inch
--------------	----------------------------------

### Geometrical Data

Width	6 mm / 0.236 inch
Height from upper-edge of DIN-35 rail	97.8 mm / 3.85 inch
Depth	94 mm / 3.701 inch

### Mechanical data

Type of mounting	DIN-35 rail
------------------	-------------

### Material Data

Color	light gray
Fire load	0.596 MJ
Weight	35.3 g

### Environmental Requirements

Surrounding air (operating) temperature	-25 ... 70 °C
Surrounding air (storage) temperature	-40 ... 85 °C

### Standards and specifications

Conformity marking	1
EMC immunity to interference	EN 61000-6-2
EMC emission of interference	EN 61000-6-4

### Commercial data

Product Group	6 (Interface Electronics)
Country of origin	DE
GTIN	4045454470128
Customs Tariff No.	85437090300

### Approvals / Certificates

#### Ex-Approvals

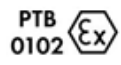

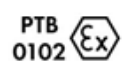

Logo	Approval	Additional Approval Text	Certificate name
	IECEX TUEV Nord Cert GmbH	EN 60079-0	TÜV_14_ATEX_112692_X



	IECEX TUEV Nord Cert GmbH	IEC 60079-0	IECEX_TUN_14.0030_X
--	------------------------------	-------------	---------------------



## Ship Approvals

Logo	Approval	Additional Approval Text	Certificate name
	<b>BV</b> Bureau Veritas S.A.	-	40179_A0
	<b>DNV GL</b> Det Norske Veritas, Germanischer Lloyd	-	TAA00001D1
	<b>NK</b> Nippon Kaiji Kyokai	-	TA17255M
	<b>PRS</b> Polski Rejestr Statków	-	TE/2186 /880590/18

## UL-Approvals

Logo	Approval	Additional Approval Text	Certificate name
	<b>UL</b> UL International Netherlands B.V. (ORDINARY LOCATIONS)	UL 508	E175199 Sec.4

## Compatible products

## power supply

**Item no.: 787-2852**

Switched-mode power supply; for JUMPFLEX® Signal Conditioners; 1-phase; 24 VDC output voltage; 1 A output current [www.wago.com/787-2852](http://www.wago.com/787-2852)

## transfer module

**Item no.: 857-980**

JUMPFLEX® adapter; with 16-pole flat cable connector per DIN 41651; analog











[www.wago.com/857-980](http://www.wago.com/857-980)

## assembling

**Item no.: 249-116**

Screwless end stop; 6 mm wide

[www.wago.com/249-116](http://www.wago.com/249-116)

	<b>Item no.: 249-117</b> Screwless end stop; 10 mm wide	<a href="http://www.wago.com/249-117">www.wago.com/249-117</a>
	<b>Item no.: 249-197</b> Screwless end stop; 14 mm wide	<a href="http://www.wago.com/249-197">www.wago.com/249-197</a>
<b>Jumper</b>		
	<b>Item no.: 281-482</b> Comb-style jumper bar; insulated; 2-way; IN = IN terminal block	<a href="http://www.wago.com/281-482">www.wago.com/281-482</a>
	<b>Item no.: 859-402</b> Push-in type jumper bar; 2-way; Nominal current 18 A; insulated	<a href="http://www.wago.com/859-402">www.wago.com/859-402</a>
	<b>Item no.: 859-402/000-005</b> Push-in type jumper bar; 2-way; Nominal current 18 A; insulated	<a href="http://www.wago.com/859-402/000-005">www.wago.com/859-402/000-005</a>
	<b>Item no.: 859-402/000-006</b> Push-in type jumper bar; 2-way; Nominal current 18 A; insulated	<a href="http://www.wago.com/859-402/000-006">www.wago.com/859-402/000-006</a>
	<b>Item no.: 859-402/000-029</b> Push-in type jumper bar; 2-way; Nominal current 18 A; insulated	<a href="http://www.wago.com/859-402/000-029">www.wago.com/859-402/000-029</a>
	<b>Item no.: 859-403</b> Push-in type jumper bar; 3-way; Nominal current 18 A; insulated	<a href="http://www.wago.com/859-403">www.wago.com/859-403</a>
	<b>Item no.: 859-403/000-005</b> Push-in type jumper bar; 3-way; Nominal current 18 A; insulated	<a href="http://www.wago.com/859-403/000-005">www.wago.com/859-403/000-005</a>
	<b>Item no.: 859-403/000-006</b> Push-in type jumper bar; 3-way; Nominal current 18 A; insulated	<a href="http://www.wago.com/859-403/000-006">www.wago.com/859-403/000-006</a>
	<b>Item no.: 859-403/000-029</b> Push-in type jumper bar; 3-way; Nominal current 18 A; insulated	<a href="http://www.wago.com/859-403/000-029">www.wago.com/859-403/000-029</a>
	<b>Item no.: 859-404</b> Push-in type jumper bar; 4-way; Nominal current 18 A; insulated	<a href="http://www.wago.com/859-404">www.wago.com/859-404</a>
	<b>Item no.: 859-404/000-005</b> Push-in type jumper bar; 4-way; Nominal current 18 A; insulated	<a href="http://www.wago.com/859-404/000-005">www.wago.com/859-404/000-005</a>
	<b>Item no.: 859-404/000-006</b> Push-in type jumper bar; 4-way; Nominal current 18 A; insulated	<a href="http://www.wago.com/859-404/000-006">www.wago.com/859-404/000-006</a>
	<b>Item no.: 859-404/000-029</b> Push-in type jumper bar; 4-way; Nominal current 18 A; insulated	<a href="http://www.wago.com/859-404/000-029">www.wago.com/859-404/000-029</a>
	<b>Item no.: 859-405</b> Push-in type jumper bar; 5-way; Nominal current 18 A; insulated	<a href="http://www.wago.com/859-405">www.wago.com/859-405</a>



**Item no.: 859-405/000-005**  
Push-in type jumper bar; 5-way; Nominal current 18 A; insulated

[www.wago.com/859-405/000-005](http://www.wago.com/859-405/000-005)



**Item no.: 859-405/000-006**  
Push-in type jumper bar; 5-way; Nominal current 18 A; insulated

[www.wago.com/859-405/000-006](http://www.wago.com/859-405/000-006)



**Item no.: 859-405/000-029**  
Push-in type jumper bar; 5-way; Nominal current 18 A; insulated

[www.wago.com/859-405/000-029](http://www.wago.com/859-405/000-029)



**Item no.: 859-406**  
Push-in type jumper bar; 6-way; Nominal current 18 A; insulated

[www.wago.com/859-406](http://www.wago.com/859-406)



**Item no.: 859-406/000-005**  
Push-in type jumper bar; 6-way; Nominal current 18 A; insulated

[www.wago.com/859-406/000-005](http://www.wago.com/859-406/000-005)



**Item no.: 859-406/000-006**  
Push-in type jumper bar; 6-way; Nominal current 18 A; insulated

[www.wago.com/859-406/000-006](http://www.wago.com/859-406/000-006)



**Item no.: 859-406/000-029**  
Push-in type jumper bar; 6-way; Nominal current 18 A; insulated

[www.wago.com/859-406/000-029](http://www.wago.com/859-406/000-029)



**Item no.: 859-407**  
Push-in type jumper bar; 7-way; Nominal current 18 A; insulated

[www.wago.com/859-407](http://www.wago.com/859-407)



**Item no.: 859-407/000-005**  
Push-in type jumper bar; 7-way; Nominal current 18 A; insulated

[www.wago.com/859-407/000-005](http://www.wago.com/859-407/000-005)



**Item no.: 859-407/000-006**  
Push-in type jumper bar; 7-way; Nominal current 18 A; insulated

[www.wago.com/859-407/000-006](http://www.wago.com/859-407/000-006)



**Item no.: 859-407/000-029**  
Push-in type jumper bar; 7-way; Nominal current 18 A; insulated

[www.wago.com/859-407/000-029](http://www.wago.com/859-407/000-029)



**Item no.: 859-408**  
Push-in type jumper bar; 8-way; Nominal current 18 A; insulated

[www.wago.com/859-408](http://www.wago.com/859-408)



**Item no.: 859-408/000-005**  
Push-in type jumper bar; 8-way; Nominal current 18 A; insulated

[www.wago.com/859-408/000-005](http://www.wago.com/859-408/000-005)



**Item no.: 859-408/000-006**  
Push-in type jumper bar; 8-way; Nominal current 18 A; insulated

[www.wago.com/859-408/000-006](http://www.wago.com/859-408/000-006)



**Item no.: 859-408/000-029**  
Push-in type jumper bar; 8-way; Nominal current 18 A; insulated

[www.wago.com/859-408/000-029](http://www.wago.com/859-408/000-029)



**Item no.: 859-409**  
Push-in type jumper bar; 9-way; Nominal current 18 A; insulated

[www.wago.com/859-409](http://www.wago.com/859-409)



**Item no.: 859-409/000-005**  
Push-in type jumper bar; 9-way; Nominal current 18 A; insulated

[www.wago.com/859-409/000-005](http://www.wago.com/859-409/000-005)



**Item no.: 859-409/000-006**  
Push-in type jumper bar; 9-way; Nominal current 18 A; insulated

[www.wago.com/859-409/000-006](http://www.wago.com/859-409/000-006)



**Item no.: 859-409/000-029**  
Push-in type jumper bar; 9-way; Nominal current 18 A; insulated

[www.wago.com/859-409/000-029](http://www.wago.com/859-409/000-029)



**Item no.: 859-410**  
Push-in type jumper bar; 10-way; Nominal current 18 A; insulated

[www.wago.com/859-410](http://www.wago.com/859-410)



**Item no.: 859-410/000-005**  
Push-in type jumper bar; 10-way; Nominal current 18 A; insulated

[www.wago.com/859-410/000-005](http://www.wago.com/859-410/000-005)



**Item no.: 859-410/000-006**  
Push-in type jumper bar; 10-way; Nominal current 18 A; insulated

[www.wago.com/859-410/000-006](http://www.wago.com/859-410/000-006)



**Item no.: 859-410/000-029**  
Push-in type jumper bar; 10-way; Nominal current 18 A; insulated

[www.wago.com/859-410/000-029](http://www.wago.com/859-410/000-029)

#### tools

**Item no.: 210-720**  
Operating tool with partially insulated shaft; Type 2, blade (3.5 x 0.5) mm

[www.wago.com/210-720](http://www.wago.com/210-720)

#### General accessories

**Item no.: 857-979**  
Supply and through module

[www.wago.com/857-979](http://www.wago.com/857-979)

#### Marking accessories

**Item no.: 2009-110**  
Marking strips; on reel; not stretchable; plain; snap-on type

[www.wago.com/2009-110](http://www.wago.com/2009-110)

**Item no.: 2009-115**  
WMB-Inline; for Smart Printer; on reel; stretchable 5 - 5.2 mm; plain; snap-on type

[www.wago.com/2009-115](http://www.wago.com/2009-115)

**Item no.: 2009-115/000-002**  
WMB-Inline; for Smart Printer; on reel; stretchable 5 - 5.2 mm; plain; snap-on type

[www.wago.com/2009-115/000-002](http://www.wago.com/2009-115/000-002)

**Item no.: 2009-115/000-006**  
WMB-Inline; for smartPRINTER; on reel; stretchable 5 - 5.2 mm; plain; snap-on type

[www.wago.com/2009-115/000-006](http://www.wago.com/2009-115/000-006)



**Item no.: 2009-115/000-007**  
WMB-Inline; for smartPRINTER; on reel; stretchable 5 - 5.2 mm; plain; snap-on type















[www.wago.com/2009-115/000-007](http://www.wago.com/2009-115/000-007)



**Item no.: 2009-115/000-012**  
WMB-Inline; for smartPRINTER; on reel; stretchable 5 - 5.2 mm; plain; snap-on type

[www.wago.com/2009-115/000-012](http://www.wago.com/2009-115/000-012)



	<p><b>Item no.: 2009-115/000-017</b>                  WMB-Inline; for smartPRINTER; on reel; stretchable 5 - 5.2 mm; plain; snap-on type</p>	<a href="http://www.wago.com/2009-115/000-017">www.wago.com/2009-115/000-017</a>
	<p><b>Item no.: 2009-115/000-023</b>                  WMB-Inline; for smartPRINTER; on reel; stretchable 5 - 5.2 mm; plain; snap-on type</p>	<a href="http://www.wago.com/2009-115/000-023">www.wago.com/2009-115/000-023</a>
	<p><b>Item no.: 2009-115/000-024</b>                  WMB-Inline; for smartPRINTER; on reel; stretchable 5 - 5.2 mm; plain; snap-on type</p>	<a href="http://www.wago.com/2009-115/000-024">www.wago.com/2009-115/000-024</a>
	<p><b>Item no.: 793-501</b>                  WMB marking card; as card; not stretchable; plain; snap-on type</p>	<a href="http://www.wago.com/793-501">www.wago.com/793-501</a>
	<p><b>Item no.: 793-501/000-002</b>                  WMB marking card; as card; not stretchable; plain; snap-on type</p>	<a href="http://www.wago.com/793-501/000-002">www.wago.com/793-501/000-002</a>
	<p><b>Item no.: 793-501/000-005</b>                  WMB marking card; as card; not stretchable; plain; snap-on type</p>	<a href="http://www.wago.com/793-501/000-005">www.wago.com/793-501/000-005</a>
	<p><b>Item no.: 793-501/000-006</b>                  WMB marking card; as card; not stretchable; plain; snap-on type</p>	<a href="http://www.wago.com/793-501/000-006">www.wago.com/793-501/000-006</a>
	<p><b>Item no.: 793-501/000-007</b>                  WMB marking card; as card; not stretchable; plain; snap-on type</p>	<a href="http://www.wago.com/793-501/000-007">www.wago.com/793-501/000-007</a>
	<p><b>Item no.: 793-501/000-012</b>                  WMB marking card; as card; not stretchable; plain; snap-on type</p>	<a href="http://www.wago.com/793-501/000-012">www.wago.com/793-501/000-012</a>
	<p><b>Item no.: 793-501/000-017</b>                  WMB marking card; as card; not stretchable; plain; snap-on type</p>	<a href="http://www.wago.com/793-501/000-017">www.wago.com/793-501/000-017</a>
	<p><b>Item no.: 793-501/000-023</b>                  WMB marking card; as card; not stretchable; plain; snap-on type</p>	<a href="http://www.wago.com/793-501/000-023">www.wago.com/793-501/000-023</a>
	<p><b>Item no.: 793-501/000-024</b>                  WMB marking card; as card; not stretchable; plain; snap-on type</p>	<a href="http://www.wago.com/793-501/000-024">www.wago.com/793-501/000-024</a>
	<p><b>Item no.: 793-502</b>                  WMB marking card; as card; MARKED; 1 ... 10 (10x); not stretchable; Horizontal marking; snap-on type</p>	<a href="http://www.wago.com/793-502">www.wago.com/793-502</a>
	<p><b>Item no.: 793-502/000-002</b>                  WMB marking card; as card; MARKED; 1 ... 10 (10x); not stretchable; Horizontal marking; snap-on type</p>	<a href="http://www.wago.com/793-502/000-002">www.wago.com/793-502/000-002</a>
	<p><b>Item no.: 793-502/000-005</b>                  WMB marking card; as card; MARKED; 1 ... 10 (10x); not stretchable; Horizontal marking; snap-on type</p>	<a href="http://www.wago.com/793-502/000-005">www.wago.com/793-502/000-005</a>

**Item no.: 793-502/000-006**

WMB marking card; as card; MARKED; 1 ... 10 (10x); not stretchable; Horizontal marking; snap-on type

[www.wago.com/793-502/000-006](http://www.wago.com/793-502/000-006)**Item no.: 793-502/000-007**

WMB marking card; as card; MARKED; 1 ... 10 (10x); not stretchable; Horizontal marking; snap-on type

[www.wago.com/793-502/000-007](http://www.wago.com/793-502/000-007)**Item no.: 793-502/000-012**

WMB marking card; as card; MARKED; 1 ... 10 (10x); not stretchable; Horizontal marking; snap-on type

[www.wago.com/793-502/000-012](http://www.wago.com/793-502/000-012)**Item no.: 793-502/000-017**

WMB marking card; as card; MARKED; 1 ... 10 (10x); not stretchable; Horizontal marking; snap-on type

[www.wago.com/793-502/000-017](http://www.wago.com/793-502/000-017)**Item no.: 793-502/000-023**

WMB marking card; as card; MARKED; 1 ... 10 (10x); not stretchable; Horizontal marking; snap-on type

[www.wago.com/793-502/000-023](http://www.wago.com/793-502/000-023)**Item no.: 793-502/000-024**

WMB marking card; as card; MARKED; 1 ... 10 (10x); not stretchable; Horizontal marking; snap-on type

[www.wago.com/793-502/000-024](http://www.wago.com/793-502/000-024)**Item no.: 793-503**

WMB marking card; as card; MARKED; 11 ... 20 (10x); not stretchable; Horizontal marking; snap-on type

[www.wago.com/793-503](http://www.wago.com/793-503)**Item no.: 793-503/000-002**

WMB marking card; as card; MARKED; 11 ... 20 (10x); not stretchable; Horizontal marking; snap-on type

[www.wago.com/793-503/000-002](http://www.wago.com/793-503/000-002)**Item no.: 793-503/000-005**

WMB marking card; as card; MARKED; 11 ... 20 (10x); not stretchable; Horizontal marking; snap-on type

[www.wago.com/793-503/000-005](http://www.wago.com/793-503/000-005)**Item no.: 793-503/000-006**

WMB marking card; as card; MARKED; 11 ... 20 (10x); not stretchable; Horizontal marking; snap-on type

[www.wago.com/793-503/000-006](http://www.wago.com/793-503/000-006)**Item no.: 793-503/000-007**

WMB marking card; as card; MARKED; 11 ... 20 (10x); not stretchable; Horizontal marking; snap-on type

[www.wago.com/793-503/000-007](http://www.wago.com/793-503/000-007)**Item no.: 793-503/000-012**

WMB marking card; as card; MARKED; 11 ... 20 (10x); not stretchable; Horizontal marking; snap-on type

[www.wago.com/793-503/000-012](http://www.wago.com/793-503/000-012)**Item no.: 793-503/000-017**

WMB marking card; as card; MARKED; 11 ... 20 (10x); not stretchable; Horizontal marking; snap-on type















[www.wago.com/793-503/000-017](http://www.wago.com/793-503/000-017)**Item no.: 793-503/000-023**

WMB marking card; as card; MARKED; 11 ... 20 (10x); not stretchable; Horizontal marking; snap-on type

[www.wago.com/793-503/000-023](http://www.wago.com/793-503/000-023)**Item no.: 793-503/000-024**

WMB marking card; as card; MARKED; 11 ... 20 (10x); not stretchable; Horizontal marking; snap-on type

[www.wago.com/793-503/000-024](http://www.wago.com/793-503/000-024)

	<p><b>Item no.: 793-504</b> WMB marking card; as card; MARKED; 21 ... 30 (10x); not stretchable; Horizontal marking; snap-on type</p>	<a href="http://www.wago.com/793-504">www.wago.com/793-504</a>
	<p><b>Item no.: 793-504/000-002</b> WMB marking card; as card; MARKED; 21 ... 30 (10x); not stretchable; Horizontal marking; snap-on type</p>	<a href="http://www.wago.com/793-504/000-002">www.wago.com/793-504/000-002</a>
	<p><b>Item no.: 793-504/000-005</b> WMB marking card; as card; MARKED; 21 ... 30 (10x); not stretchable; Horizontal marking; snap-on type</p>	<a href="http://www.wago.com/793-504/000-005">www.wago.com/793-504/000-005</a>
	<p><b>Item no.: 793-504/000-006</b> WMB marking card; as card; MARKED; 21 ... 30 (10x); not stretchable; Horizontal marking; snap-on type</p>	<a href="http://www.wago.com/793-504/000-006">www.wago.com/793-504/000-006</a>
	<p><b>Item no.: 793-504/000-012</b> WMB marking card; as card; MARKED; 21 ... 30 (10x); not stretchable; Horizontal marking; snap-on type</p>	<a href="http://www.wago.com/793-504/000-012">www.wago.com/793-504/000-012</a>
	<p><b>Item no.: 793-504/000-017</b> WMB marking card; as card; MARKED; 21 ... 30 (10x); not stretchable; Horizontal marking; snap-on type</p>	<a href="http://www.wago.com/793-504/000-017">www.wago.com/793-504/000-017</a>
	<p><b>Item no.: 793-504/000-023</b> WMB marking card; as card; MARKED; 21 ... 30 (10x); not stretchable; Horizontal marking; snap-on type</p>	<a href="http://www.wago.com/793-504/000-023">www.wago.com/793-504/000-023</a>
	<p><b>Item no.: 793-505</b> WMB marking card; as card; MARKED; 31 ... 40 (10x); not stretchable; Horizontal marking; snap-on type</p>	<a href="http://www.wago.com/793-505">www.wago.com/793-505</a>
	<p><b>Item no.: 793-505/000-005</b> WMB marking card; as card; MARKED; 31 ... 40 (10x); not stretchable; Horizontal marking; snap-on type</p>	<a href="http://www.wago.com/793-505/000-005">www.wago.com/793-505/000-005</a>
	<p><b>Item no.: 793-505/000-006</b> WMB marking card; as card; MARKED; 31 ... 40 (10x); not stretchable; Horizontal marking; snap-on type</p>	<a href="http://www.wago.com/793-505/000-006">www.wago.com/793-505/000-006</a>
	<p><b>Item no.: 793-505/000-007</b> WMB marking card; as card; MARKED; 31 ... 40 (10x); not stretchable; Horizontal marking; snap-on type</p>	<a href="http://www.wago.com/793-505/000-007">www.wago.com/793-505/000-007</a>
	<p><b>Item no.: 793-505/000-012</b> WMB marking card; as card; MARKED; 31 ... 40 (10x); not stretchable; Horizontal marking; snap-on type</p>	<a href="http://www.wago.com/793-505/000-012">www.wago.com/793-505/000-012</a>
	<p><b>Item no.: 793-506</b> WMB marking card; as card; MARKED; 41 ... 50 (10x); not stretchable; Horizontal marking; snap-on type</p>	<a href="http://www.wago.com/793-506">www.wago.com/793-506</a>
	<p><b>Item no.: 793-506/000-005</b> WMB marking card; as card; MARKED; 41 ... 50 (10x); not stretchable; Horizontal marking; snap-on type</p>	<a href="http://www.wago.com/793-506/000-005">www.wago.com/793-506/000-005</a>
	<p><b>Item no.: 793-506/000-006</b> WMB marking card; as card; MARKED; 41 ... 50 (10x); not stretchable; Horizontal marking; snap-on type</p>	<a href="http://www.wago.com/793-506/000-006">www.wago.com/793-506/000-006</a>

**Item no.: 793-506/000-012**

WMB marking card; as card; MARKED; 41 ... 50 (10x); not stretchable; Horizontal marking; snap-on type [www.wago.com/793-506/000-012](http://www.wago.com/793-506/000-012)

**Item no.: 793-506/000-017**

WMB marking card; as card; MARKED; 41 ... 50 (10x); not stretchable; Horizontal marking; snap-on type [www.wago.com/793-506/000-017](http://www.wago.com/793-506/000-017)

**Item no.: 793-5501**

WMB marking card; as card; for terminal block width 5 - 17.5 mm; stretchable 5 - 5.2 mm; plain; snap-on type [www.wago.com/793-5501](http://www.wago.com/793-5501)

**Item no.: 793-5501/000-002**

WMB marking card; as card; for terminal block width 5 - 17.5 mm; stretchable 5 - 5.2 mm; plain; snap-on type [www.wago.com/793-5501/000-002](http://www.wago.com/793-5501/000-002)

**Item no.: 793-5501/000-005**

WMB marking card; as card; stretchable 5 - 5.2 mm; plain; snap-on type [www.wago.com/793-5501/000-005](http://www.wago.com/793-5501/000-005)

**Item no.: 793-5501/000-006**

WMB marking card; as card; stretchable 5 - 5.2 mm; plain; snap-on type [www.wago.com/793-5501/000-006](http://www.wago.com/793-5501/000-006)

**Item no.: 793-5501/000-007**

WMB marking card; as card; stretchable 5 - 5.2 mm; plain; snap-on type [www.wago.com/793-5501/000-007](http://www.wago.com/793-5501/000-007)

**Item no.: 793-5501/000-012**

WMB marking card; as card; stretchable 5 - 5.2 mm; plain; snap-on type [www.wago.com/793-5501/000-012](http://www.wago.com/793-5501/000-012)

**Item no.: 793-5501/000-014**

WMB marking card; as card; stretchable 5 - 5.2 mm; plain; snap-on type [www.wago.com/793-5501/000-014](http://www.wago.com/793-5501/000-014)

**Item no.: 793-5501/000-017**

WMB marking card; as card; stretchable 5 - 5.2 mm; plain; snap-on type [www.wago.com/793-5501/000-017](http://www.wago.com/793-5501/000-017)

**Item no.: 793-5501/000-023**

WMB marking card; as card; stretchable 5 - 5.2 mm; plain; snap-on type [www.wago.com/793-5501/000-023](http://www.wago.com/793-5501/000-023)

**Item no.: 793-5501/000-024**

WMB marking card; as card; stretchable 5 - 5.2 mm; plain; snap-on type [www.wago.com/793-5501/000-024](http://www.wago.com/793-5501/000-024)

**Item no.: 793-566**

WMB marking card; as card; MARKED; 1 ... 50 (2x); not stretchable; Horizontal marking; snap-on type [www.wago.com/793-566](http://www.wago.com/793-566)

**Item no.: 793-566/000-002**

WMB marking card; as card; MARKED; 1 ... 50 (2x); not stretchable; Horizontal marking; snap-on type [www.wago.com/793-566/000-002](http://www.wago.com/793-566/000-002)

**Item no.: 793-566/000-005**

WMB marking card; as card; MARKED; 1 ... 50 (2x); not stretchable; Horizontal marking; snap-on type [www.wago.com/793-566/000-005](http://www.wago.com/793-566/000-005)



Item no.: 793-566/000-006

WMB marking card; as card; MARKED; 1 ... 50 (2x); not stretchable; Horizontal marking; snap-on type

[www.wago.com/793-566/000-006](http://www.wago.com/793-566/000-006)



Item no.: 793-566/000-007

WMB marking card; as card; MARKED; 1 ... 50 (2x); not stretchable; Horizontal marking; snap-on type

[www.wago.com/793-566/000-007](http://www.wago.com/793-566/000-007)



Item no.: 793-566/000-012

WMB marking card; as card; MARKED; 1 ... 50 (2x); not stretchable; Horizontal marking; snap-on type

[www.wago.com/793-566/000-012](http://www.wago.com/793-566/000-012)



Item no.: 793-566/000-017

WMB marking card; as card; MARKED; 1 ... 50 (2x); not stretchable; Horizontal marking; snap-on type

[www.wago.com/793-566/000-017](http://www.wago.com/793-566/000-017)



Item no.: 793-566/000-023

WMB marking card; as card; MARKED; 1 ... 50 (2x); not stretchable; Horizontal marking; snap-on type

[www.wago.com/793-566/000-023](http://www.wago.com/793-566/000-023)



Item no.: 793-566/000-024

WMB marking card; as card; MARKED; 1 ... 50 (2x); not stretchable; Horizontal marking; snap-on type

[www.wago.com/793-566/000-024](http://www.wago.com/793-566/000-024)

## Downloads

### Documentation

#### Instruction Leaflet

Signal Conditioners and Isolating Amps	10 13, 10	pdf	Download
Temperature transducer Pt100, Pt200, Pt500, Pt1000, Resistors 0 ... 1 kOhm, 0 ... 4.5 kOhm DIP switch		2.2 MB	

#### Additional Information

Disposal; Electrical and electronic equipment, Packaging	V 1.0.0 10 10, 18	pdf 265.8 kB	Download
--	----------------------	-----------------	----------

## CAD/CAE - Smart Data

### CAD data

3D Download 857-800		URL	Download
Step file 857-08xx Series	1.0 06 30, 11	STP 348.4 kB	Download



Subject to changes.

---

WAGO Kontakttechnik GmbH & Co. KG  
Hansastr. 27  
32423 Minden  
Phone: +49571 887-0 | Fax: +49571 887-169  
Email: [info.de@wago.com](mailto:info.de@wago.com) | Web: [www.wago.com](http://www.wago.com)

Do you have any questions about our products?  
We are always happy to take your call at {0}.