

Data sheet | Item number: 857-801

Temperature signal conditioner for RTD sensors; Current and voltage output signal; Configuration via software; Supply voltage: 24 VDC; 6 mm module width

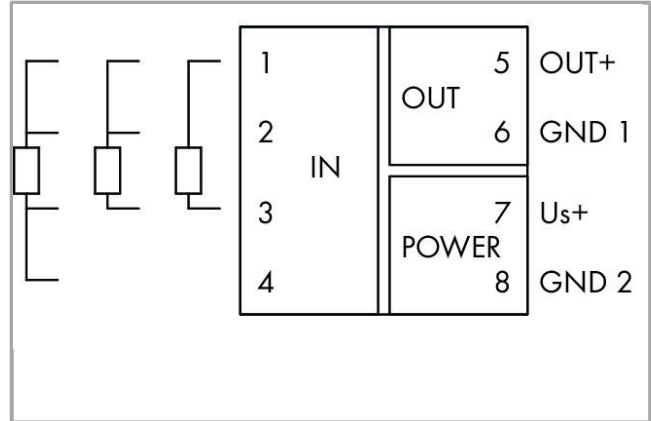

www.wago.com/857-801

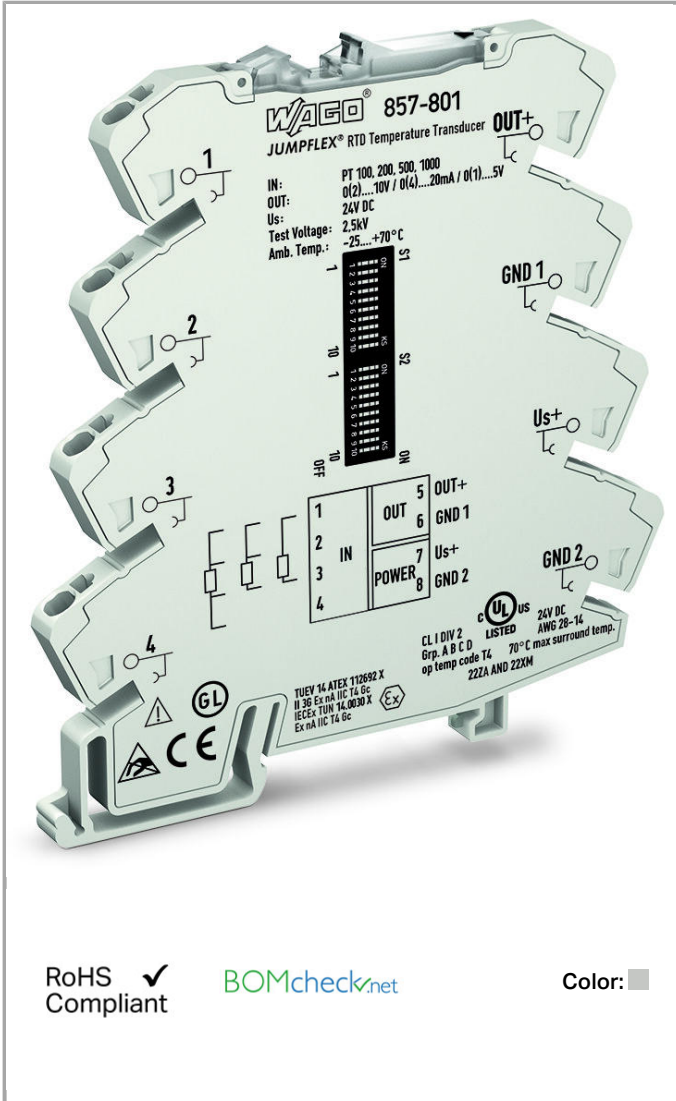

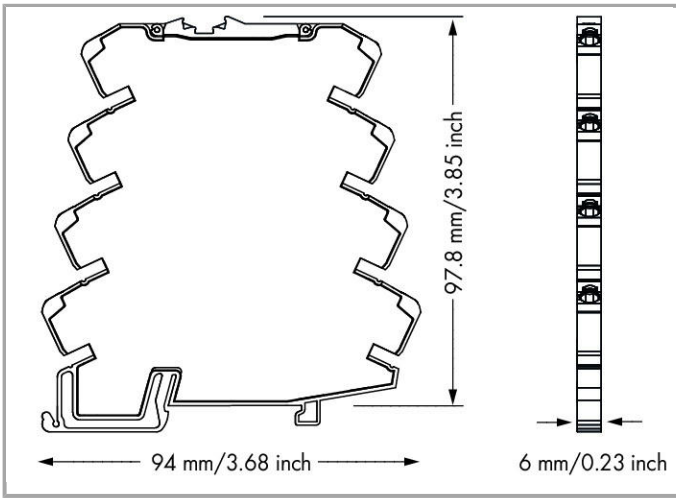

857-801
DIP Switch Adjustability

• = ON Default

DIP Switch S1

Wire Connection	Sensor Type	Output Signal	Measurement Range Underflow	Measurement Range Overflow	Wire Break	Short Circuit
2-wire	Pt100	0...20 mA	Lower limit of output range - 5 %*	Upper limit of output range + 2.5 %*	Upper limit of output range + 5 %*	Lower limit of output range - 2.5 %*
3-wire	Pt200	4...20 mA				
4-wire	Pt500	0...10 mA	Lower limit of output range	Upper limit of output range + 2.5 %	Upper limit of output range + 5 %	Lower limit of output range
	Pt1000	2...10 mA	Lower limit of output range	Upper limit of output range	Upper limit of output range + 5 %	Lower limit of output range
	1 kΩ	0...10 V	Lower limit of output range	Upper limit of output range	Upper limit of output range + 5 %	Lower limit of output range
	4.5 kΩ	2...10 V	Lower limit of output range	Upper limit of output range	Upper limit of output range + 5 %	Lower limit of output range
		0...5 V	Lower limit of output range	Upper limit of output range	Upper limit of output range	Lower limit of output range
		1...5 V	Lower limit of output range	Upper limit of output range	Upper limit of output range	Lower limit of output range

* acc. to NAMUR NE 43

DIP Switch S2

Start Temperature										End Temperature																				
1	2	3	4	°C	°F	5	6	7	8	9	10	°C	°F	5	6	7	8	9	10	°C	°F	5	6	7	8	9	10	°C	°F	
•	•	•	•	0	32	•	•	•	•	•	•	100	212	•	•	•	•	•	•	•	75	167	•	•	•	•	•	•	210	410
•	•	•	•	-200	-328	•	•	•	•	•	•	0	32	•	•	•	•	•	•	•	80	176	•	•	•	•	•	•	220	428
•	•	•	•	-175	-283	•	•	•	•	•	•	5	41	•	•	•	•	•	•	•	85	185	•	•	•	•	•	•	230	446
•	•	•	•	-150	-238	•	•	•	•	•	•	10	50	•	•	•	•	•	•	•	90	194	•	•	•	•	•	•	240	464
•	•	•	•	-125	-193	•	•	•	•	•	•	15	59	•	•	•	•	•	•	•	95	203	•	•	•	•	•	•	250	482
•	•	•	•	-100	-148	•	•	•	•	•	•	20	68	•	•	•	•	•	•	•	100	212	•	•	•	•	•	•	260	500
•	•	•	•	-90	-130	•	•	•	•	•	•	25	77	•	•	•	•	•	•	•	110	230	•	•	•	•	•	•	270	518
•	•	•	•	-80	-112	•	•	•	•	•	•	30	86	•	•	•	•	•	•	•	120	248	•	•	•	•	•	•	280	536
•	•	•	•	-70	-94	•	•	•	•	•	•	35	95	•	•	•	•	•	•	•	130	266	•	•	•	•	•	•	280	554
•	•	•	•	-60	-76	•	•	•	•	•	•	40	104	•	•	•	•	•	•	•	140	284	•	•	•	•	•	•	300	572
•	•	•	•	-50	-58	•	•	•	•	•	•	45	113	•	•	•	•	•	•	•	150	302	•	•	•	•	•	•	325	617
•	•	•	•	-40	-40	•	•	•	•	•	•	50	122	•	•	•	•	•	•	•	160	320	•	•	•	•	•	•	350	652
•	•	•	•	-30	-22	•	•	•	•	•	•	55	131	•	•	•	•	•	•	•	170	338	•	•	•	•	•	•	375	707
•	•	•	•	-20	-4	•	•	•	•	•	•	60	140	•	•	•	•	•	•	•	180	356	•	•	•	•	•	•	400	752
•	•	•	•	-10	14	•	•	•	•	•	•	65	149	•	•	•	•	•	•	•	190	374	•	•	•	•	•	•	425	797
•	•	•	•	0	32	•	•	•	•	•	•	70	158	•	•	•	•	•	•	•	200	392	•	•	•	•	•	•	450	842

The minimum distance from the start temperature to the end temperature may not fall short of 50K degrees on the Celsius (C) scale or 122K degrees on the Fahrenheit (F) scale.

Item description

Short description:

This temperature signal conditioner records Pt100, Pt200, Pt500, and Pt1000 Sensors, as well as resistors up to 4.5 kOhm, converting the temperature signal into a standard analog signal on the output side.

Features:

- PC configuration interface
- For Pt100, Pt200, Pt500 and Pt1000 sensors, as well as resistors up to 4.5 kOhm
- 2-, 3-, and 4-wire connection technology.
- Detect calibrated measurement range switching
- Detect wire break/sensor short circuit
- Measurement range underflow/overflow
- Integrate a switchable clipping function to limit the standard analog signal to the upper range values
- Safe 3-way isolation with 2.5 kV test voltage per EN 61140

Note:

Additional setting options as well as output signal inversion via interface configuration software or interface configuration app

Data

Technical Data

Configuration

Configuration options

DIP switches
Interface configuration software
Interface configuration app

Input

Input signal type	Pt sensors Resistance
-------------------	--------------------------

Input – RTD sensors

Sensor types (RTD)	Pt100 Pt200 Pt500 Pt1000
Sensor connection	2-wire; 3-wire; 4-wire (switchable)
Max. sensor supply current (RTD)	≤ 0.5 mA
Measurement range temperature (RTD)	-200 ... 850°C
Min. measuring span (RTD)	50 K

Input – Resistors

Input range resistance	0 ... 1 kΩ; 0 ... 4.5 kΩ
Min. measuring span	50 Ω

Output

Output signal type	Current Voltage
Output signal voltage	0 ... 5 V; 1 ... 5 V; 0 ... 10 V; 2 ... 10 V
Output signal current	0 ... 10 mA; 2 ... 10 mA; 0 ... 20 mA; 4 ... 20 mA
Load impedance (output/voltage)	≥ 2 kΩ
Load impedance (output/current)	≤ 600 Ω

Signal processing

Step response typ.	180 ms (2-wire); 360 ms (3-wire)
--------------------	----------------------------------

Measurement error

Transmission error typ.	≤ 0.1 % at max. measuring span
Transmission error of set measurement range	≤ ((10 K/set measurement range [K]) + 0,1) %
Temperature coefficient	≤ 0.02 %/K

Power supply

Type of power supply	24 VDC
Nominal supply voltage U_S	DC 24 V
Supply voltage range	±30 %
Current consumption at supply voltage	≤ 40 mA

Safety and protection:

Test voltage (input/output/supply)	AC 2.5 kV; 50 Hz; 1 min
Protection class	IP20

Connection data

Connection technology	Push-in CAGE CLAMP®
Solid conductor	0.08 ... 2.5 mm ² / 28 ... 14 AWG
Fine-stranded conductor	0.34 ... 2.5 mm ² / 22 ... 14 AWG
Strip length	9 ... 10 mm / 0.35 ... 0.39 inch

Geometrical Data

Width	6 mm / 0.236 inch
Height from upper-edge of DIN-35 rail	97.8 mm / 3.85 inch
Depth	94 mm / 3.701 inch

Mechanical data

Type of mounting	DIN-35 rail
------------------	-------------

Material Data

Color	light gray
Fire load	0.596 MJ
Weight	35.1 g

Environmental Requirements

Surrounding air (operating) temperature	-25 ... 70 °C
Surrounding air (storage) temperature	-40 ... 85 °C

Standards and specifications



Conformity marking	1
EMC immunity to interference	EN 61000-6-2
EMC emission of interference	EN 61000-6-4

Commercial data



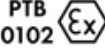

Product Group	6 (Interface Electronics)
Country of origin	DE
GTIN	4045454502713
Customs Tariff No.	85437090300

Approvals / Certificates

Ex-Approvals

Logo	Approval	Additional Approval Text	Certificate name
	IECEX TUEV Nord Cert GmbH	EN 60079-0	TÜV_14_ATEX_112692_X
	IECEX TUEV Nord Cert GmbH	IEC 60079-0	IECEX_TUN_14.0030_X

Ship Approvals

Logo	Approval	Additional Approval Text	Certificate name
	BV Bureau Veritas S.A.	-	40179_A0
	DNV GL Det Norske Veritas, Germanischer Lloyd	-	TAA00001D1
	NK Nippon Kaiji Kyokai	-	TA17255M
	PRS Polski Rejestr Statków	-	TE/2186 /880590/18

UL-Approvals

Logo	Approval	Additional Approval Text	Certificate name
	UL UL International Netherlands B.V. (ORDINARY LOCATIONS)	UL 508	E175199 Sec.4

Compatible products

power supply

Item no.: 787-2852

Switched-mode power supply; for JUMPFLEX® Signal Conditioners; 1-phase; 24 VDC output voltage; 1 A output current www.wago.com/787-2852

Marking accessories

Item no.: 2009-110

Marking strips; on reel; not stretchable; plain; snap-on type www.wago.com/2009-110

Item no.: 2009-115

WMB-Inline; for Smart Printer; on reel; stretchable 5 - 5.2 mm; plain; snap-on type www.wago.com/2009-115

**Item no.: 2009-115/000-002**

WMB-Inline; for Smart Printer; on reel; stretchable 5 - 5.2 mm; plain; snap-on type www.wago.com/2009-115/000-002

Item no.: 2009-115/000-006

WMB-Inline; for smartPRINTER; on reel; stretchable 5 - 5.2 mm; plain; snap-on type www.wago.com/2009-115/000-006

Item no.: 2009-115/000-007

WMB-Inline; for smartPRINTER; on reel; stretchable 5 - 5.2 mm; plain; snap-on type www.wago.com/2009-115/000-007

Item no.: 2009-115/000-012

WMB-Inline; for smartPRINTER; on reel; stretchable 5 - 5.2 mm; plain; snap-on type www.wago.com/2009-115/000-012

**Item no.: 2009-115/000-017**

WMB-Inline; for smartPRINTER; on reel; stretchable 5 - 5.2 mm; plain; snap-on type www.wago.com/2009-115/000-017

**Item no.: 2009-115/000-023**

WMB-Inline; for smartPRINTER; on reel; stretchable 5 - 5.2 mm; plain; snap-on type www.wago.com/2009-115/000-023

**Item no.: 2009-115/000-024**

WMB-Inline; for smartPRINTER; on reel; stretchable 5 - 5.2 mm; plain; snap-on type www.wago.com/2009-115/000-024

**Item no.: 793-501**

WMB marking card; as card; not stretchable; plain; snap-on type www.wago.com/793-501

**Item no.: 793-501/000-002**

WMB marking card; as card; not stretchable; plain; snap-on type www.wago.com/793-501/000-002

**Item no.: 793-501/000-005**

WMB marking card; as card; not stretchable; plain; snap-on type www.wago.com/793-501/000-005

**Item no.: 793-501/000-006**

WMB marking card; as card; not stretchable; plain; snap-on type www.wago.com/793-501/000-006



Item no.: 793-501/000-007
WMB marking card; as card; not stretchable; plain; snap-on type

www.wago.com/793-501/000-007



Item no.: 793-501/000-012
WMB marking card; as card; not stretchable; plain; snap-on type

www.wago.com/793-501/000-012



Item no.: 793-501/000-017
WMB marking card; as card; not stretchable; plain; snap-on type

www.wago.com/793-501/000-017



Item no.: 793-501/000-023
WMB marking card; as card; not stretchable; plain; snap-on type

www.wago.com/793-501/000-023



Item no.: 793-501/000-024
WMB marking card; as card; not stretchable; plain; snap-on type

www.wago.com/793-501/000-024



Item no.: 793-502
WMB marking card; as card; MARKED; 1 ... 10 (10x); not stretchable; Horizontal marking; snap-on type

www.wago.com/793-502



Item no.: 793-502/000-002
WMB marking card; as card; MARKED; 1 ... 10 (10x); not stretchable; Horizontal marking; snap-on type

www.wago.com/793-502/000-002



Item no.: 793-502/000-005
WMB marking card; as card; MARKED; 1 ... 10 (10x); not stretchable; Horizontal marking; snap-on type

www.wago.com/793-502/000-005



Item no.: 793-502/000-006
WMB marking card; as card; MARKED; 1 ... 10 (10x); not stretchable; Horizontal marking; snap-on type

www.wago.com/793-502/000-006



Item no.: 793-502/000-007
WMB marking card; as card; MARKED; 1 ... 10 (10x); not stretchable; Horizontal marking; snap-on type

www.wago.com/793-502/000-007



Item no.: 793-502/000-012
WMB marking card; as card; MARKED; 1 ... 10 (10x); not stretchable; Horizontal marking; snap-on type

www.wago.com/793-502/000-012



Item no.: 793-502/000-017
WMB marking card; as card; MARKED; 1 ... 10 (10x); not stretchable; Horizontal marking; snap-on type

www.wago.com/793-502/000-017



Item no.: 793-502/000-023
WMB marking card; as card; MARKED; 1 ... 10 (10x); not stretchable; Horizontal marking; snap-on type

www.wago.com/793-502/000-023



Item no.: 793-502/000-024
WMB marking card; as card; MARKED; 1 ... 10 (10x); not stretchable; Horizontal marking; snap-on type

www.wago.com/793-502/000-024



Item no.: 793-503
WMB marking card; as card; MARKED; 11 ... 20 (10x); not stretchable; Horizontal marking; snap-on type

www.wago.com/793-503



Item no.: 793-503/000-002 www.wago.com/793-503/000-002
 WMB marking card; as card; MARKED; 11 ... 20 (10x); not stretchable; Horizontal marking; snap-on type



Item no.: 793-503/000-005 www.wago.com/793-503/000-005
 WMB marking card; as card; MARKED; 11 ... 20 (10x); not stretchable; Horizontal marking; snap-on type



Item no.: 793-503/000-006 www.wago.com/793-503/000-006
 WMB marking card; as card; MARKED; 11 ... 20 (10x); not stretchable; Horizontal marking; snap-on type



Item no.: 793-503/000-007 www.wago.com/793-503/000-007
 WMB marking card; as card; MARKED; 11 ... 20 (10x); not stretchable; Horizontal marking; snap-on type



Item no.: 793-503/000-012 www.wago.com/793-503/000-012
 WMB marking card; as card; MARKED; 11 ... 20 (10x); not stretchable; Horizontal marking; snap-on type



Item no.: 793-503/000-017 www.wago.com/793-503/000-017
 WMB marking card; as card; MARKED; 11 ... 20 (10x); not stretchable; Horizontal marking; snap-on type



Item no.: 793-503/000-023 www.wago.com/793-503/000-023
 WMB marking card; as card; MARKED; 11 ... 20 (10x); not stretchable; Horizontal marking; snap-on type



Item no.: 793-503/000-024 www.wago.com/793-503/000-024
 WMB marking card; as card; MARKED; 11 ... 20 (10x); not stretchable; Horizontal marking; snap-on type



Item no.: 793-504 www.wago.com/793-504
 WMB marking card; as card; MARKED; 21 ... 30 (10x); not stretchable; Horizontal marking; snap-on type



Item no.: 793-504/000-002 www.wago.com/793-504/000-002
 WMB marking card; as card; MARKED; 21 ... 30 (10x); not stretchable; Horizontal marking; snap-on type



Item no.: 793-504/000-005 www.wago.com/793-504/000-005
 WMB marking card; as card; MARKED; 21 ... 30 (10x); not stretchable; Horizontal marking; snap-on type



Item no.: 793-504/000-006 www.wago.com/793-504/000-006
 WMB marking card; as card; MARKED; 21 ... 30 (10x); not stretchable; Horizontal marking; snap-on type

















Item no.: 793-504/000-012 www.wago.com/793-504/000-012
 WMB marking card; as card; MARKED; 21 ... 30 (10x); not stretchable; Horizontal marking; snap-on type



Item no.: 793-504/000-017 www.wago.com/793-504/000-017
 WMB marking card; as card; MARKED; 21 ... 30 (10x); not stretchable; Horizontal marking; snap-on type



Item no.: 793-504/000-023 www.wago.com/793-504/000-023
 WMB marking card; as card; MARKED; 21 ... 30 (10x); not stretchable; Horizontal marking; snap-on type

	Item no.: 793-505 WMB marking card; as card; MARKED; 31 ... 40 (10x); not stretchable; Horizontal marking; snap-on type	www.wago.com/793-505
	Item no.: 793-505/000-005 WMB marking card; as card; MARKED; 31 ... 40 (10x); not stretchable; Horizontal marking; snap-on type	www.wago.com/793-505/000-005
	Item no.: 793-505/000-006 WMB marking card; as card; MARKED; 31 ... 40 (10x); not stretchable; Horizontal marking; snap-on type	www.wago.com/793-505/000-006
	Item no.: 793-505/000-007 WMB marking card; as card; MARKED; 31 ... 40 (10x); not stretchable; Horizontal marking; snap-on type	www.wago.com/793-505/000-007
	Item no.: 793-505/000-012 WMB marking card; as card; MARKED; 31 ... 40 (10x); not stretchable; Horizontal marking; snap-on type	www.wago.com/793-505/000-012
	Item no.: 793-506 WMB marking card; as card; MARKED; 41 ... 50 (10x); not stretchable; Horizontal marking; snap-on type	www.wago.com/793-506
	Item no.: 793-506/000-005 WMB marking card; as card; MARKED; 41 ... 50 (10x); not stretchable; Horizontal marking; snap-on type	www.wago.com/793-506/000-005
	Item no.: 793-506/000-006 WMB marking card; as card; MARKED; 41 ... 50 (10x); not stretchable; Horizontal marking; snap-on type	www.wago.com/793-506/000-006
	Item no.: 793-506/000-012 WMB marking card; as card; MARKED; 41 ... 50 (10x); not stretchable; Horizontal marking; snap-on type	www.wago.com/793-506/000-012
	Item no.: 793-506/000-017 WMB marking card; as card; MARKED; 41 ... 50 (10x); not stretchable; Horizontal marking; snap-on type	www.wago.com/793-506/000-017
	Item no.: 793-5501 WMB marking card; as card; for terminal block width 5 - 17.5 mm; stretchable 5 - 5.2 mm; plain; snap-on type	www.wago.com/793-5501
	Item no.: 793-5501/000-002 WMB marking card; as card; for terminal block width 5 - 17.5 mm; stretchable 5 - 5.2 mm; plain; snap-on type	www.wago.com/793-5501/000-002
	Item no.: 793-5501/000-005 WMB marking card; as card; stretchable 5 - 5.2 mm; plain; snap-on type	www.wago.com/793-5501/000-005
	Item no.: 793-5501/000-006 WMB marking card; as card; stretchable 5 - 5.2 mm; plain; snap-on type	www.wago.com/793-5501/000-006
	Item no.: 793-5501/000-007 WMB marking card; as card; stretchable 5 - 5.2 mm; plain; snap-on type	www.wago.com/793-5501/000-007



Item no.: 793-5501/000-012
WMB marking card; as card; stretchable 5 - 5.2 mm; plain; snap-on type

www.wago.com/793-5501/000-012



Item no.: 793-5501/000-014
WMB marking card; as card; stretchable 5 - 5.2 mm; plain; snap-on type

www.wago.com/793-5501/000-014



Item no.: 793-5501/000-017
WMB marking card; as card; stretchable 5 - 5.2 mm; plain; snap-on type

www.wago.com/793-5501/000-017



Item no.: 793-5501/000-023
WMB marking card; as card; stretchable 5 - 5.2 mm; plain; snap-on type

www.wago.com/793-5501/000-023



Item no.: 793-5501/000-024
WMB marking card; as card; stretchable 5 - 5.2 mm; plain; snap-on type

www.wago.com/793-5501/000-024



Item no.: 793-566
WMB marking card; as card; MARKED; 1 ... 50 (2x); not stretchable; Horizontal marking; snap-on type

www.wago.com/793-566



Item no.: 793-566/000-002
WMB marking card; as card; MARKED; 1 ... 50 (2x); not stretchable; Horizontal marking; snap-on type

www.wago.com/793-566/000-002



Item no.: 793-566/000-005
WMB marking card; as card; MARKED; 1 ... 50 (2x); not stretchable; Horizontal marking; snap-on type

www.wago.com/793-566/000-005



Item no.: 793-566/000-006
WMB marking card; as card; MARKED; 1 ... 50 (2x); not stretchable; Horizontal marking; snap-on type

www.wago.com/793-566/000-006



Item no.: 793-566/000-007
WMB marking card; as card; MARKED; 1 ... 50 (2x); not stretchable; Horizontal marking; snap-on type

www.wago.com/793-566/000-007



Item no.: 793-566/000-012
WMB marking card; as card; MARKED; 1 ... 50 (2x); not stretchable; Horizontal marking; snap-on type

www.wago.com/793-566/000-012



Item no.: 793-566/000-017
WMB marking card; as card; MARKED; 1 ... 50 (2x); not stretchable; Horizontal marking; snap-on type

www.wago.com/793-566/000-017



Item no.: 793-566/000-023
WMB marking card; as card; MARKED; 1 ... 50 (2x); not stretchable; Horizontal marking; snap-on type

www.wago.com/793-566/000-023









Item no.: 793-566/000-024
WMB marking card; as card; MARKED; 1 ... 50 (2x); not stretchable; Horizontal marking; snap-on type

www.wago.com/793-566/000-024

assembling

Item no.: 249-116
Screwless end stop; 6 mm wide

www.wago.com/249-116

	Item no.: 249-117 Screwless end stop; 10 mm wide	www.wago.com/249-117
	Item no.: 249-197 Screwless end stop; 14 mm wide	www.wago.com/249-197
tools		
	Item no.: 210-720 Operating tool with partially insulated shaft; Type 2, blade (3.5 x 0.5) mm	www.wago.com/210-720
General accessories		
	Item no.: 750-921 Bluetooth® Adapter	www.wago.com/750-921
	Item no.: 750-923 Configuration cable; USB connector	www.wago.com/750-923
	Item no.: 750-923/000-001 Configuration cable; USB connector; Length: 5 m	www.wago.com/750-923/000-001
	Item no.: 857-979 Supply and through module	www.wago.com/857-979
transfer module		
	Item no.: 857-980 JUMPFLEX® adapter; with 16-pole flat cable connector per DIN 41651; analog	www.wago.com/857-980
Jumper		
	Item no.: 281-482 Comb-style jumper bar; insulated; 2-way; IN = IN terminal block	www.wago.com/281-482
	Item no.: 859-402 Push-in type jumper bar; 2-way; Nominal current 18 A; insulated	www.wago.com/859-402
	Item no.: 859-402/000-005 Push-in type jumper bar; 2-way; Nominal current 18 A; insulated	www.wago.com/859-402/000-005
	Item no.: 859-402/000-006 Push-in type jumper bar; 2-way; Nominal current 18 A; insulated	www.wago.com/859-402/000-006
	Item no.: 859-402/000-029 Push-in type jumper bar; 2-way; Nominal current 18 A; insulated	www.wago.com/859-402/000-029
	Item no.: 859-403 Push-in type jumper bar; 3-way; Nominal current 18 A; insulated	www.wago.com/859-403
	Item no.: 859-403/000-005 Push-in type jumper bar; 3-way; Nominal current 18 A; insulated	www.wago.com/859-403/000-005
	Item no.: 859-403/000-006 Push-in type jumper bar; 3-way; Nominal current 18 A; insulated	www.wago.com/859-403/000-006



Item no.: 859-403/000-029
Push-in type jumper bar; 3-way; Nominal current 18 A; insulated

www.wago.com/859-403/000-029



Item no.: 859-404
Push-in type jumper bar; 4-way; Nominal current 18 A; insulated

www.wago.com/859-404



Item no.: 859-404/000-005
Push-in type jumper bar; 4-way; Nominal current 18 A; insulated

www.wago.com/859-404/000-005



Item no.: 859-404/000-006
Push-in type jumper bar; 4-way; Nominal current 18 A; insulated

www.wago.com/859-404/000-006



Item no.: 859-404/000-029
Push-in type jumper bar; 4-way; Nominal current 18 A; insulated

www.wago.com/859-404/000-029



Item no.: 859-405
Push-in type jumper bar; 5-way; Nominal current 18 A; insulated

www.wago.com/859-405



Item no.: 859-405/000-005
Push-in type jumper bar; 5-way; Nominal current 18 A; insulated

www.wago.com/859-405/000-005



Item no.: 859-405/000-006
Push-in type jumper bar; 5-way; Nominal current 18 A; insulated

www.wago.com/859-405/000-006



Item no.: 859-405/000-029
Push-in type jumper bar; 5-way; Nominal current 18 A; insulated

www.wago.com/859-405/000-029



Item no.: 859-406
Push-in type jumper bar; 6-way; Nominal current 18 A; insulated

www.wago.com/859-406



Item no.: 859-406/000-005
Push-in type jumper bar; 6-way; Nominal current 18 A; insulated

www.wago.com/859-406/000-005



Item no.: 859-406/000-006
Push-in type jumper bar; 6-way; Nominal current 18 A; insulated

www.wago.com/859-406/000-006



Item no.: 859-406/000-029
Push-in type jumper bar; 6-way; Nominal current 18 A; insulated

www.wago.com/859-406/000-029



Item no.: 859-407
Push-in type jumper bar; 7-way; Nominal current 18 A; insulated

www.wago.com/859-407















Item no.: 859-407/000-005
Push-in type jumper bar; 7-way; Nominal current 18 A; insulated

www.wago.com/859-407/000-005



Item no.: 859-407/000-006
Push-in type jumper bar; 7-way; Nominal current 18 A; insulated

www.wago.com/859-407/000-006

	Item no.: 859-407/000-029 Push-in type jumper bar; 7-way; Nominal current 18 A; insulated	www.wago.com/859-407/000-029
	Item no.: 859-408 Push-in type jumper bar; 8-way; Nominal current 18 A; insulated	www.wago.com/859-408
	Item no.: 859-408/000-005 Push-in type jumper bar; 8-way; Nominal current 18 A; insulated	www.wago.com/859-408/000-005
	Item no.: 859-408/000-006 Push-in type jumper bar; 8-way; Nominal current 18 A; insulated	www.wago.com/859-408/000-006
	Item no.: 859-408/000-029 Push-in type jumper bar; 8-way; Nominal current 18 A; insulated	www.wago.com/859-408/000-029
	Item no.: 859-409 Push-in type jumper bar; 9-way; Nominal current 18 A; insulated	www.wago.com/859-409
	Item no.: 859-409/000-005 Push-in type jumper bar; 9-way; Nominal current 18 A; insulated	www.wago.com/859-409/000-005
	Item no.: 859-409/000-006 Push-in type jumper bar; 9-way; Nominal current 18 A; insulated	www.wago.com/859-409/000-006
	Item no.: 859-409/000-029 Push-in type jumper bar; 9-way; Nominal current 18 A; insulated	www.wago.com/859-409/000-029
	Item no.: 859-410 Push-in type jumper bar; 10-way; Nominal current 18 A; insulated	www.wago.com/859-410
	Item no.: 859-410/000-005 Push-in type jumper bar; 10-way; Nominal current 18 A; insulated	www.wago.com/859-410/000-005
	Item no.: 859-410/000-006 Push-in type jumper bar; 10-way; Nominal current 18 A; insulated	www.wago.com/859-410/000-006
	Item no.: 859-410/000-029 Push-in type jumper bar; 10-way; Nominal current 18 A; insulated	www.wago.com/859-410/000-029

Downloads

Documentation

Instruction Leaflet

Measurement Transducer and Isolation Amplifier

13-oct-2010

pdf
2.2 MB

Download



Temperature transducer Pt100, Pt200, Pt500, Pt1000, Resistors 0 ... 1 kOhm, 0 ... 4.5 kOhm DIP switch / FDT/DTM GUI

Additional Information

Disposal; Electrical and electronic equipment, Packaging	V 1.0.0 10-oct-2018	pdf 265.8 kB	Download
--	------------------------	-----------------	----------

Engineering-Software

Software for Interface-Products

Interface Configuration Software FULL The full setup, in addition to the WAGO Interface Configuration Software, includes the installation for the Microsoft .NET Framework.	1.6.2.11 14-ene-2019	exe 97.5 MB	Download
--	-------------------------	----------------	----------

Interface Configuration Software SMALL The full setup only includes the WAGO Interface Configuration Software.	1.6.2.11 14-ene-2019	exe 47.1 MB	Download
---	-------------------------	----------------	----------

CAD/CAE - Smart Data

CAD data

3D Download 857-801	URL	Download
---------------------	-----	----------

Subject to changes.