

Data sheet | Item number: 857-811

Temperature signal conditioner for thermocouples; Current and voltage output signal; Configuration via software; Supply voltage: 24 VDC; 6 mm module width

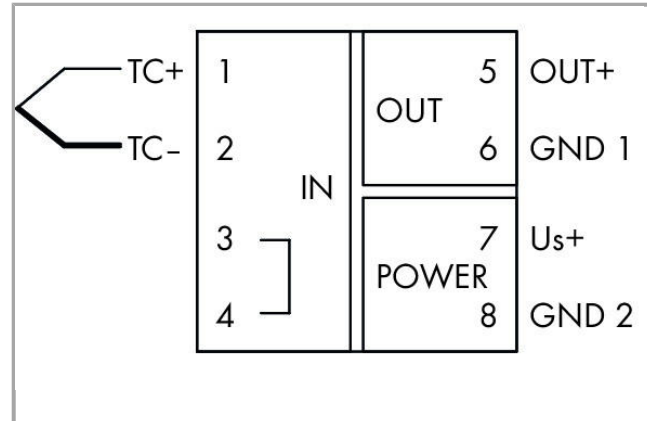

[www.wago.com/857-811](http://www.wago.com/857-811)

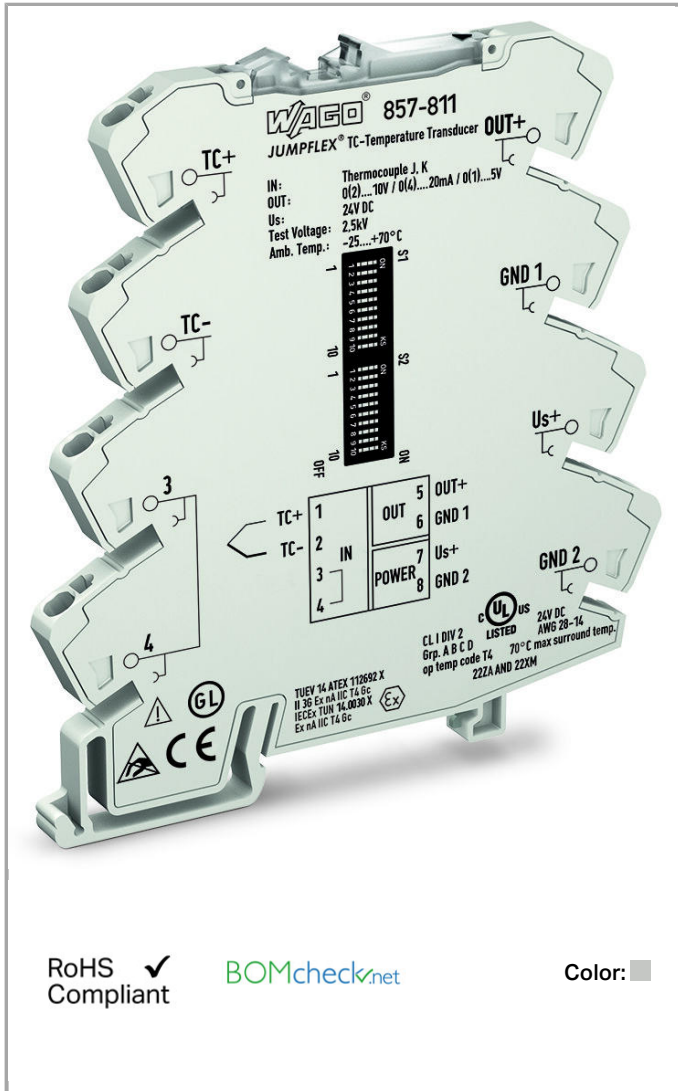



## Input

Input signal type	TC sensors
-------------------	------------

## Input – TC sensors

Sensor types (TC)	Type J Type K
Measurement range temperature (TC)	-150 ... 1200 °C (Type J); -150 ... 1350 °C (Type K)
Min. measuring span (TC)	100 K
Cold junction compensation	On/Off (Default: On)
Cold junction error	3 K (typ. 2 K)

## Output

Output signal type	Current Voltage
Output signal voltage	0 ... 5 V; 1 ... 5 V; 0 ... 10 V; 2 ... 10 V
Output signal current	0 ... 10 mA; 2 ... 10 mA; 0 ... 20 mA; 4 ... 20 mA
Load impedance (output/voltage)	$\geq 2 \text{ k}\Omega$
Load impedance (output/current)	$\leq 600 \Omega$

## Signal processing

Step response typ.	60 ms (cold junction compensation off); 120 ms (cold junction compensation on)
--------------------	--------------------------------------------------------------------------------

## Measurement error

Transmission error typ.	$\leq 0.1 \%$ at max. measuring span (Type J, K)
Transmission error of set measurement range	$\leq (150 \text{ K}/\text{set measurement range [K]}) \%$
Temperature coefficient	$\leq 0.04 \%/K$

## Power supply

Type of power supply	24 VDC
Nominal supply voltage $U_S$	DC 24 V
Supply voltage range	$\pm 30 \%$
Current consumption at supply voltage	$\leq 40 \text{ mA}$

## Safety and protection:

Test voltage (input/output/supply)	AC 2.5 kV; 50 Hz; 1 min
Protection class	IP20



## Connection data

Connection technology	Push-in CAGE CLAMP®
Solid conductor	0.08 ... 2.5 mm <sup>2</sup> / 28 ... 14 AWG
Fine-stranded conductor	0.34 ... 2.5 mm <sup>2</sup> / 22 ... 14 AWG
Strip length	9 ... 10 mm / 0.35 ... 0.39 inch

## Geometrical Data

Width	6 mm / 0.236 inch
Height from upper-edge of DIN-35 rail	97.8 mm / 3.85 inch
Depth	94 mm / 3.701 inch

## Mechanical data

Type of mounting	DIN-35 rail
------------------	-------------

## Material Data

Color	light gray
Fire load	0.598 MJ
Weight	36 g

## Environmental Requirements

Surrounding air (operating) temperature	-25 ... 70 °C
Surrounding air (storage) temperature	-40 ... 85 °C

## Standards and specifications

Conformity marking	1
EMC immunity to interference	EN 61000-6-2
EMC emission of interference	EN 61000-6-4

## Commercial data

Product Group	6 (Interface Electronics)
Country of origin	DE
GTIN	4045454502751
Customs Tariff No.	85437090300

## Approvals / Certificates

### Ex-Approvals

Logo	Approval	Additional Approval Text	Certificate name
	IECEX TUEV Nord Cert GmbH	EN 60079-0	TÜV_14_ATEX_112692_X

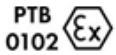





IECEX  
TUEV Nord Cert GmbH

IEC 60079-0

IECEX\_TUN\_14.0030\_X

## Ship Approvals

Logo	Approval	Additional Approval Text	Certificate name
	<b>BV</b> Bureau Veritas S.A.	-	40179_A0
	<b>DNV GL</b> Det Norske Veritas, Germanischer Lloyd	-	TAA00001D1
	<b>NK</b> Nippon Kaiji Kyokai	-	TA17255M
	<b>PRS</b> Polski Rejestr Statków	-	TE/2186 /880590/18

## UL-Approvals















Logo	Approval	Additional Approval Text	Certificate name
	<b>UL</b> UL International Netherlands B.V. (ORDINARY LOCATIONS)	UL 508	E175199 Sec.4

## Compatible products

## Jumper

Item no.: 281-482  
Comb-style jumper bar; insulated; 2-way; IN = IN terminal block

[www.wago.com/281-482](http://www.wago.com/281-482)

	<b>Item no.: 859-402</b> Push-in type jumper bar; 2-way; Nominal current 18 A; insulated	<a href="http://www.wago.com/859-402">www.wago.com/859-402</a>
	<b>Item no.: 859-402/000-005</b> Push-in type jumper bar; 2-way; Nominal current 18 A; insulated	<a href="http://www.wago.com/859-402/000-005">www.wago.com/859-402/000-005</a>
	<b>Item no.: 859-402/000-006</b> Push-in type jumper bar; 2-way; Nominal current 18 A; insulated	<a href="http://www.wago.com/859-402/000-006">www.wago.com/859-402/000-006</a>
	<b>Item no.: 859-402/000-029</b> Push-in type jumper bar; 2-way; Nominal current 18 A; insulated	<a href="http://www.wago.com/859-402/000-029">www.wago.com/859-402/000-029</a>
	<b>Item no.: 859-403</b> Push-in type jumper bar; 3-way; Nominal current 18 A; insulated	<a href="http://www.wago.com/859-403">www.wago.com/859-403</a>
	<b>Item no.: 859-403/000-005</b> Push-in type jumper bar; 3-way; Nominal current 18 A; insulated	<a href="http://www.wago.com/859-403/000-005">www.wago.com/859-403/000-005</a>
	<b>Item no.: 859-403/000-006</b> Push-in type jumper bar; 3-way; Nominal current 18 A; insulated	<a href="http://www.wago.com/859-403/000-006">www.wago.com/859-403/000-006</a>
	<b>Item no.: 859-403/000-029</b> Push-in type jumper bar; 3-way; Nominal current 18 A; insulated	<a href="http://www.wago.com/859-403/000-029">www.wago.com/859-403/000-029</a>
	<b>Item no.: 859-404</b> Push-in type jumper bar; 4-way; Nominal current 18 A; insulated	<a href="http://www.wago.com/859-404">www.wago.com/859-404</a>
	<b>Item no.: 859-404/000-005</b> Push-in type jumper bar; 4-way; Nominal current 18 A; insulated	<a href="http://www.wago.com/859-404/000-005">www.wago.com/859-404/000-005</a>
	<b>Item no.: 859-404/000-006</b> Push-in type jumper bar; 4-way; Nominal current 18 A; insulated	<a href="http://www.wago.com/859-404/000-006">www.wago.com/859-404/000-006</a>
	<b>Item no.: 859-404/000-029</b> Push-in type jumper bar; 4-way; Nominal current 18 A; insulated	<a href="http://www.wago.com/859-404/000-029">www.wago.com/859-404/000-029</a>
	<b>Item no.: 859-405</b> Push-in type jumper bar; 5-way; Nominal current 18 A; insulated	<a href="http://www.wago.com/859-405">www.wago.com/859-405</a>
	<b>Item no.: 859-405/000-005</b> Push-in type jumper bar; 5-way; Nominal current 18 A; insulated	<a href="http://www.wago.com/859-405/000-005">www.wago.com/859-405/000-005</a>
	<b>Item no.: 859-405/000-006</b> Push-in type jumper bar; 5-way; Nominal current 18 A; insulated	<a href="http://www.wago.com/859-405/000-006">www.wago.com/859-405/000-006</a>



**Item no.: 859-405/000-029**  
Push-in type jumper bar; 5-way; Nominal current 18 A; insulated

[www.wago.com/859-405/000-029](http://www.wago.com/859-405/000-029)



**Item no.: 859-406**  
Push-in type jumper bar; 6-way; Nominal current 18 A; insulated

[www.wago.com/859-406](http://www.wago.com/859-406)



**Item no.: 859-406/000-005**  
Push-in type jumper bar; 6-way; Nominal current 18 A; insulated

[www.wago.com/859-406/000-005](http://www.wago.com/859-406/000-005)



**Item no.: 859-406/000-006**  
Push-in type jumper bar; 6-way; Nominal current 18 A; insulated

[www.wago.com/859-406/000-006](http://www.wago.com/859-406/000-006)



**Item no.: 859-406/000-029**  
Push-in type jumper bar; 6-way; Nominal current 18 A; insulated

[www.wago.com/859-406/000-029](http://www.wago.com/859-406/000-029)



**Item no.: 859-407**  
Push-in type jumper bar; 7-way; Nominal current 18 A; insulated

[www.wago.com/859-407](http://www.wago.com/859-407)



**Item no.: 859-407/000-005**  
Push-in type jumper bar; 7-way; Nominal current 18 A; insulated

[www.wago.com/859-407/000-005](http://www.wago.com/859-407/000-005)



**Item no.: 859-407/000-006**  
Push-in type jumper bar; 7-way; Nominal current 18 A; insulated

[www.wago.com/859-407/000-006](http://www.wago.com/859-407/000-006)



**Item no.: 859-407/000-029**  
Push-in type jumper bar; 7-way; Nominal current 18 A; insulated

[www.wago.com/859-407/000-029](http://www.wago.com/859-407/000-029)



**Item no.: 859-408**  
Push-in type jumper bar; 8-way; Nominal current 18 A; insulated

[www.wago.com/859-408](http://www.wago.com/859-408)



**Item no.: 859-408/000-005**  
Push-in type jumper bar; 8-way; Nominal current 18 A; insulated

[www.wago.com/859-408/000-005](http://www.wago.com/859-408/000-005)



**Item no.: 859-408/000-006**  
Push-in type jumper bar; 8-way; Nominal current 18 A; insulated

[www.wago.com/859-408/000-006](http://www.wago.com/859-408/000-006)



**Item no.: 859-408/000-029**  
Push-in type jumper bar; 8-way; Nominal current 18 A; insulated

[www.wago.com/859-408/000-029](http://www.wago.com/859-408/000-029)



**Item no.: 859-409**  
Push-in type jumper bar; 9-way; Nominal current 18 A; insulated

[www.wago.com/859-409](http://www.wago.com/859-409)



**Item no.: 859-409/000-005**  
Push-in type jumper bar; 9-way; Nominal current 18 A; insulated

[www.wago.com/859-409/000-005](http://www.wago.com/859-409/000-005)



**Item no.: 859-409/000-006**  
Push-in type jumper bar; 9-way; Nominal current 18 A; insulated

[www.wago.com/859-409/000-006](http://www.wago.com/859-409/000-006)



**Item no.: 859-409/000-029**  
Push-in type jumper bar; 9-way; Nominal current 18 A; insulated

[www.wago.com/859-409/000-029](http://www.wago.com/859-409/000-029)



**Item no.: 859-410**  
Push-in type jumper bar; 10-way; Nominal current 18 A; insulated

[www.wago.com/859-410](http://www.wago.com/859-410)



**Item no.: 859-410/000-005**  
Push-in type jumper bar; 10-way; Nominal current 18 A; insulated

[www.wago.com/859-410/000-005](http://www.wago.com/859-410/000-005)



**Item no.: 859-410/000-006**  
Push-in type jumper bar; 10-way; Nominal current 18 A; insulated

[www.wago.com/859-410/000-006](http://www.wago.com/859-410/000-006)



**Item no.: 859-410/000-029**  
Push-in type jumper bar; 10-way; Nominal current 18 A; insulated

[www.wago.com/859-410/000-029](http://www.wago.com/859-410/000-029)

#### assembling

**Item no.: 249-116**  
Screwless end stop; 6 mm wide

[www.wago.com/249-116](http://www.wago.com/249-116)

**Item no.: 249-117**  
Screwless end stop; 10 mm wide

[www.wago.com/249-117](http://www.wago.com/249-117)



**Item no.: 249-197**  
Screwless end stop; 14 mm wide

[www.wago.com/249-197](http://www.wago.com/249-197)

#### General accessories

**Item no.: 750-921**  
Bluetooth® Adapter

[www.wago.com/750-921](http://www.wago.com/750-921)

**Item no.: 750-923**  
Configuration cable; USB connector

[www.wago.com/750-923](http://www.wago.com/750-923)

**Item no.: 750-923/000-001**  
Configuration cable; USB connector; Length: 5 m

[www.wago.com/750-923/000-001](http://www.wago.com/750-923/000-001)

**Item no.: 857-979**  
Supply and through module

[www.wago.com/857-979](http://www.wago.com/857-979)

#### tools

**Item no.: 210-720**  
Operating tool with partially insulated shaft; Type 2, blade (3.5 x 0.5) mm

[www.wago.com/210-720](http://www.wago.com/210-720)

#### power supply

**Item no.: 787-2852**  
Switched-mode power supply; for JUMPFLEX® Signal Conditioners; 1-phase; 24 VDC output voltage; 1 A output current

[www.wago.com/787-2852](http://www.wago.com/787-2852)

#### Marking accessories















**Item no.: 2009-110**  
Marking strips; on reel; not stretchable; plain; snap-on type

[www.wago.com/2009-110](http://www.wago.com/2009-110)

**Item no.: 2009-115**  
WMB-Inline; for Smart Printer; on reel; stretchable 5 - 5.2 mm; plain; snap-on type

[www.wago.com/2009-115](http://www.wago.com/2009-115)



	<p><b>Item no.: 2009-115/000-002</b> WMB-Inline; for Smart Printer; on reel; stretchable 5 - 5.2 mm; plain; snap-on type</p>	<p><a href="http://www.wago.com/2009-115/000-002">www.wago.com/2009-115/000-002</a></p>
	<p><b>Item no.: 2009-115/000-006</b> WMB-Inline; for smartPRINTER; on reel; stretchable 5 - 5.2 mm; plain; snap-on type</p>	<p><a href="http://www.wago.com/2009-115/000-006">www.wago.com/2009-115/000-006</a></p>
	<p><b>Item no.: 2009-115/000-007</b> WMB-Inline; for Smart Printer; on reel; stretchable 5 - 5.2 mm; plain; snap-on type</p>	<p><a href="http://www.wago.com/2009-115/000-007">www.wago.com/2009-115/000-007</a></p>
	<p><b>Item no.: 2009-115/000-012</b> WMB-Inline; for smartPRINTER; on reel; stretchable 5 - 5.2 mm; plain; snap-on type</p>	<p><a href="http://www.wago.com/2009-115/000-012">www.wago.com/2009-115/000-012</a></p>
	<p><b>Item no.: 2009-115/000-017</b> WMB-Inline; for smartPRINTER; on reel; stretchable 5 - 5.2 mm; plain; snap-on type</p>	<p><a href="http://www.wago.com/2009-115/000-017">www.wago.com/2009-115/000-017</a></p>
	<p><b>Item no.: 2009-115/000-023</b> WMB-Inline; for Smart Printer; on reel; stretchable 5 - 5.2 mm; plain; snap-on type</p>	<p><a href="http://www.wago.com/2009-115/000-023">www.wago.com/2009-115/000-023</a></p>
	<p><b>Item no.: 2009-115/000-024</b> WMB-Inline; for smartPRINTER; on reel; stretchable 5 - 5.2 mm; plain; snap-on type</p>	<p><a href="http://www.wago.com/2009-115/000-024">www.wago.com/2009-115/000-024</a></p>
	<p><b>Item no.: 793-501</b> WMB marking card; as card; not stretchable; plain; snap-on type</p>	<p><a href="http://www.wago.com/793-501">www.wago.com/793-501</a></p>
	<p><b>Item no.: 793-501/000-002</b> WMB marking card; as card; not stretchable; plain; snap-on type</p>	<p><a href="http://www.wago.com/793-501/000-002">www.wago.com/793-501/000-002</a></p>
	<p><b>Item no.: 793-501/000-005</b> WMB marking card; as card; not stretchable; plain; snap-on type</p>	<p><a href="http://www.wago.com/793-501/000-005">www.wago.com/793-501/000-005</a></p>
	<p><b>Item no.: 793-501/000-006</b> WMB marking card; as card; not stretchable; plain; snap-on type</p>	<p><a href="http://www.wago.com/793-501/000-006">www.wago.com/793-501/000-006</a></p>
	<p><b>Item no.: 793-501/000-007</b> WMB marking card; as card; not stretchable; plain; snap-on type</p>	<p><a href="http://www.wago.com/793-501/000-007">www.wago.com/793-501/000-007</a></p>
	<p><b>Item no.: 793-501/000-012</b> WMB marking card; as card; not stretchable; plain; snap-on type</p>	<p><a href="http://www.wago.com/793-501/000-012">www.wago.com/793-501/000-012</a></p>
	<p><b>Item no.: 793-501/000-017</b> WMB marking card; as card; not stretchable; plain; snap-on type</p>	<p><a href="http://www.wago.com/793-501/000-017">www.wago.com/793-501/000-017</a></p>
	<p><b>Item no.: 793-501/000-023</b> WMB marking card; as card; not stretchable; plain; snap-on type</p>	<p><a href="http://www.wago.com/793-501/000-023">www.wago.com/793-501/000-023</a></p>



**Item no.: 793-501/000-024**  
WMB marking card; as card; not stretchable; plain; snap-on type

[www.wago.com/793-501/000-024](http://www.wago.com/793-501/000-024)



**Item no.: 793-502**  
WMB marking card; as card; MARKED; 1 ... 10 (10x); not stretchable; Horizontal marking; snap-on type

[www.wago.com/793-502](http://www.wago.com/793-502)



**Item no.: 793-502/000-002**  
WMB marking card; as card; MARKED; 1 ... 10 (10x); not stretchable; Horizontal marking; snap-on type

[www.wago.com/793-502/000-002](http://www.wago.com/793-502/000-002)



**Item no.: 793-502/000-005**  
WMB marking card; as card; MARKED; 1 ... 10 (10x); not stretchable; Horizontal marking; snap-on type

[www.wago.com/793-502/000-005](http://www.wago.com/793-502/000-005)



**Item no.: 793-502/000-006**  
WMB marking card; as card; MARKED; 1 ... 10 (10x); not stretchable; Horizontal marking; snap-on type

[www.wago.com/793-502/000-006](http://www.wago.com/793-502/000-006)



**Item no.: 793-502/000-007**  
WMB marking card; as card; MARKED; 1 ... 10 (10x); not stretchable; Horizontal marking; snap-on type

[www.wago.com/793-502/000-007](http://www.wago.com/793-502/000-007)



**Item no.: 793-502/000-012**  
WMB marking card; as card; MARKED; 1 ... 10 (10x); not stretchable; Horizontal marking; snap-on type

[www.wago.com/793-502/000-012](http://www.wago.com/793-502/000-012)



**Item no.: 793-502/000-017**  
WMB marking card; as card; MARKED; 1 ... 10 (10x); not stretchable; Horizontal marking; snap-on type

[www.wago.com/793-502/000-017](http://www.wago.com/793-502/000-017)



**Item no.: 793-502/000-023**  
WMB marking card; as card; MARKED; 1 ... 10 (10x); not stretchable; Horizontal marking; snap-on type

[www.wago.com/793-502/000-023](http://www.wago.com/793-502/000-023)



**Item no.: 793-502/000-024**  
WMB marking card; as card; MARKED; 1 ... 10 (10x); not stretchable; Horizontal marking; snap-on type

[www.wago.com/793-502/000-024](http://www.wago.com/793-502/000-024)



**Item no.: 793-503**  
WMB marking card; as card; MARKED; 11 ... 20 (10x); not stretchable; Horizontal marking; snap-on type

[www.wago.com/793-503](http://www.wago.com/793-503)



**Item no.: 793-503/000-002**  
WMB marking card; as card; MARKED; 11 ... 20 (10x); not stretchable; Horizontal marking; snap-on type

[www.wago.com/793-503/000-002](http://www.wago.com/793-503/000-002)



**Item no.: 793-503/000-005**  
WMB marking card; as card; MARKED; 11 ... 20 (10x); not stretchable; Horizontal marking; snap-on type

[www.wago.com/793-503/000-005](http://www.wago.com/793-503/000-005)



**Item no.: 793-503/000-006**  
WMB marking card; as card; MARKED; 11 ... 20 (10x); not stretchable; Horizontal marking; snap-on type

[www.wago.com/793-503/000-006](http://www.wago.com/793-503/000-006)



**Item no.: 793-503/000-007**  
WMB marking card; as card; MARKED; 11 ... 20 (10x); not stretchable; Horizontal marking; snap-on type

[www.wago.com/793-503/000-007](http://www.wago.com/793-503/000-007)



**Item no.: 793-503/000-012** [www.wago.com/793-503/000-012](http://www.wago.com/793-503/000-012)  
 WMB marking card; as card; MARKED; 11 ... 20 (10x); not stretchable; Horizontal marking; snap-on type



**Item no.: 793-503/000-017** [www.wago.com/793-503/000-017](http://www.wago.com/793-503/000-017)  
 WMB marking card; as card; MARKED; 11 ... 20 (10x); not stretchable; Horizontal marking; snap-on type



**Item no.: 793-503/000-023** [www.wago.com/793-503/000-023](http://www.wago.com/793-503/000-023)  
 WMB marking card; as card; MARKED; 11 ... 20 (10x); not stretchable; Horizontal marking; snap-on type



**Item no.: 793-503/000-024** [www.wago.com/793-503/000-024](http://www.wago.com/793-503/000-024)  
 WMB marking card; as card; MARKED; 11 ... 20 (10x); not stretchable; Horizontal marking; snap-on type



**Item no.: 793-504** [www.wago.com/793-504](http://www.wago.com/793-504)  
 WMB marking card; as card; MARKED; 21 ... 30 (10x); not stretchable; Horizontal marking; snap-on type



**Item no.: 793-504/000-002** [www.wago.com/793-504/000-002](http://www.wago.com/793-504/000-002)  
 WMB marking card; as card; MARKED; 21 ... 30 (10x); not stretchable; Horizontal marking; snap-on type



**Item no.: 793-504/000-005** [www.wago.com/793-504/000-005](http://www.wago.com/793-504/000-005)  
 WMB marking card; as card; MARKED; 21 ... 30 (10x); not stretchable; Horizontal marking; snap-on type



**Item no.: 793-504/000-006** [www.wago.com/793-504/000-006](http://www.wago.com/793-504/000-006)  
 WMB marking card; as card; MARKED; 21 ... 30 (10x); not stretchable; Horizontal marking; snap-on type



**Item no.: 793-504/000-012** [www.wago.com/793-504/000-012](http://www.wago.com/793-504/000-012)  
 WMB marking card; as card; MARKED; 21 ... 30 (10x); not stretchable; Horizontal marking; snap-on type



**Item no.: 793-504/000-017** [www.wago.com/793-504/000-017](http://www.wago.com/793-504/000-017)  
 WMB marking card; as card; MARKED; 21 ... 30 (10x); not stretchable; Horizontal marking; snap-on type



**Item no.: 793-504/000-023** [www.wago.com/793-504/000-023](http://www.wago.com/793-504/000-023)  
 WMB marking card; as card; MARKED; 21 ... 30 (10x); not stretchable; Horizontal marking; snap-on type



**Item no.: 793-505** [www.wago.com/793-505](http://www.wago.com/793-505)  
 WMB marking card; as card; MARKED; 31 ... 40 (10x); not stretchable; Horizontal marking; snap-on type



**Item no.: 793-505/000-005** [www.wago.com/793-505/000-005](http://www.wago.com/793-505/000-005)  
 WMB marking card; as card; MARKED; 31 ... 40 (10x); not stretchable; Horizontal marking; snap-on type



**Item no.: 793-505/000-006** [www.wago.com/793-505/000-006](http://www.wago.com/793-505/000-006)  
 WMB marking card; as card; MARKED; 31 ... 40 (10x); not stretchable; Horizontal marking; snap-on type



**Item no.: 793-505/000-007** [www.wago.com/793-505/000-007](http://www.wago.com/793-505/000-007)  
 WMB marking card; as card; MARKED; 31 ... 40 (10x); not stretchable; Horizontal marking; snap-on type

**Item no.: 793-505/000-012**

WMB marking card; as card; MARKED; 31 ... 40 (10x); not stretchable; Horizontal marking; snap-on type [www.wago.com/793-505/000-012](http://www.wago.com/793-505/000-012)

**Item no.: 793-506**

WMB marking card; as card; MARKED; 41 ... 50 (10x); not stretchable; Horizontal marking; snap-on type [www.wago.com/793-506](http://www.wago.com/793-506)

**Item no.: 793-506/000-005**

WMB marking card; as card; MARKED; 41 ... 50 (10x); not stretchable; Horizontal marking; snap-on type [www.wago.com/793-506/000-005](http://www.wago.com/793-506/000-005)

**Item no.: 793-506/000-006**

WMB marking card; as card; MARKED; 41 ... 50 (10x); not stretchable; Horizontal marking; snap-on type [www.wago.com/793-506/000-006](http://www.wago.com/793-506/000-006)

**Item no.: 793-506/000-012**

WMB marking card; as card; MARKED; 41 ... 50 (10x); not stretchable; Horizontal marking; snap-on type [www.wago.com/793-506/000-012](http://www.wago.com/793-506/000-012)

**Item no.: 793-506/000-017**

WMB marking card; as card; MARKED; 41 ... 50 (10x); not stretchable; Horizontal marking; snap-on type [www.wago.com/793-506/000-017](http://www.wago.com/793-506/000-017)

**Item no.: 793-5501**

WMB marking card; as card; for terminal block width 5 - 17.5 mm; stretchable 5 - 5.2 mm; plain; snap-on type [www.wago.com/793-5501](http://www.wago.com/793-5501)

**Item no.: 793-5501/000-002**

WMB marking card; as card; for terminal block width 5 - 17.5 mm; stretchable 5 - 5.2 mm; plain; snap-on type [www.wago.com/793-5501/000-002](http://www.wago.com/793-5501/000-002)

**Item no.: 793-5501/000-005**

WMB marking card; as card; stretchable 5 - 5.2 mm; plain; snap-on type [www.wago.com/793-5501/000-005](http://www.wago.com/793-5501/000-005)

**Item no.: 793-5501/000-006**

WMB marking card; as card; stretchable 5 - 5.2 mm; plain; snap-on type [www.wago.com/793-5501/000-006](http://www.wago.com/793-5501/000-006)

**Item no.: 793-5501/000-007**

WMB marking card; as card; stretchable 5 - 5.2 mm; plain; snap-on type [www.wago.com/793-5501/000-007](http://www.wago.com/793-5501/000-007)

**Item no.: 793-5501/000-012**

WMB marking card; as card; stretchable 5 - 5.2 mm; plain; snap-on type [www.wago.com/793-5501/000-012](http://www.wago.com/793-5501/000-012)

**Item no.: 793-5501/000-014**









WMB marking card; as card; stretchable 5 - 5.2 mm; plain; snap-on type [www.wago.com/793-5501/000-014](http://www.wago.com/793-5501/000-014)

**Item no.: 793-5501/000-017**

WMB marking card; as card; stretchable 5 - 5.2 mm; plain; snap-on type [www.wago.com/793-5501/000-017](http://www.wago.com/793-5501/000-017)

**Item no.: 793-5501/000-023**

WMB marking card; as card; stretchable 5 - 5.2 mm; plain; snap-on type [www.wago.com/793-5501/000-023](http://www.wago.com/793-5501/000-023)

	<b>Item no.: 793-5501/000-024</b> WMB marking card; as card; stretchable 5 - 5.2 mm; plain; snap-on type	<a href="http://www.wago.com/793-5501/000-024">www.wago.com/793-5501/000-024</a>
	<b>Item no.: 793-566</b> WMB marking card; as card; MARKED; 1 ... 50 (2x); not stretchable; Horizontal marking; snap-on type	<a href="http://www.wago.com/793-566">www.wago.com/793-566</a>
	<b>Item no.: 793-566/000-002</b> WMB marking card; as card; MARKED; 1 ... 50 (2x); not stretchable; Horizontal marking; snap-on type	<a href="http://www.wago.com/793-566/000-002">www.wago.com/793-566/000-002</a>
	<b>Item no.: 793-566/000-005</b> WMB marking card; as card; MARKED; 1 ... 50 (2x); not stretchable; Horizontal marking; snap-on type	<a href="http://www.wago.com/793-566/000-005">www.wago.com/793-566/000-005</a>
	<b>Item no.: 793-566/000-006</b> WMB marking card; as card; MARKED; 1 ... 50 (2x); not stretchable; Horizontal marking; snap-on type	<a href="http://www.wago.com/793-566/000-006">www.wago.com/793-566/000-006</a>
	<b>Item no.: 793-566/000-007</b> WMB marking card; as card; MARKED; 1 ... 50 (2x); not stretchable; Horizontal marking; snap-on type	<a href="http://www.wago.com/793-566/000-007">www.wago.com/793-566/000-007</a>
	<b>Item no.: 793-566/000-012</b> WMB marking card; as card; MARKED; 1 ... 50 (2x); not stretchable; Horizontal marking; snap-on type	<a href="http://www.wago.com/793-566/000-012">www.wago.com/793-566/000-012</a>
	<b>Item no.: 793-566/000-017</b> WMB marking card; as card; MARKED; 1 ... 50 (2x); not stretchable; Horizontal marking; snap-on type	<a href="http://www.wago.com/793-566/000-017">www.wago.com/793-566/000-017</a>
	<b>Item no.: 793-566/000-023</b> WMB marking card; as card; MARKED; 1 ... 50 (2x); not stretchable; Horizontal marking; snap-on type	<a href="http://www.wago.com/793-566/000-023">www.wago.com/793-566/000-023</a>
	<b>Item no.: 793-566/000-024</b> WMB marking card; as card; MARKED; 1 ... 50 (2x); not stretchable; Horizontal marking; snap-on type	<a href="http://www.wago.com/793-566/000-024">www.wago.com/793-566/000-024</a>

**transfer module**

<b>Item no.: 857-980</b> Interface adapter; 16-pole; analog	<a href="http://www.wago.com/857-980">www.wago.com/857-980</a>
----------------------------------------------------------------	----------------------------------------------------------------

**Downloads****Documentation****Instruction Leaflet**

Measurement Transducer and Isolation Amplifier	13-oct-2010	pdf	Download
Temperature transducer Thermocouples Typ J, K DIP switch / FDT/DTM GUI		2.4 MB	

**Additional Information**

Disposal; Electrical and electronic equipment, Packaging	V 1.0.0	pdf	Download
	10-oct-2018	265.8 kB	



## Engineering-Software

### Software for Interface-Products

Interface Configuration Software FULL	1.6.2.11	exe	Download
The full setup, in addition to the WAGO Interface Configuration Software, includes the installation for the Microsoft .NET Framework.	14-ene-2019	97.5 MB	

Interface Configuration Software SMALL	1.6.2.11	exe	Download
The full setup only includes the WAGO Interface Configuration Software.	14-ene-2019	47.1 MB	

## CAD/CAE - Smart Data

### CAD data

3D Download 857-811		URL	Download
---------------------	--	-----	----------

Subject to changes.