

# XPSUAF

## Safety Module

Original instructions

11/2020



---

The information provided in this documentation contains general descriptions and/or technical characteristics of the performance of the products contained herein. This documentation is not intended as a substitute for and is not to be used for determining suitability or reliability of these products for specific user applications. It is the duty of any such user or integrator to perform the appropriate and complete risk analysis, evaluation and testing of the products with respect to the relevant specific application or use thereof. Neither Schneider Electric nor any of its affiliates or subsidiaries shall be responsible or liable for misuse of the information contained herein. If you have any suggestions for improvements or amendments or have found errors in this publication, please notify us.

You agree not to reproduce, other than for your own personal, noncommercial use, all or part of this document on any medium whatsoever without permission of Schneider Electric, given in writing. You also agree not to establish any hypertext links to this document or its content. Schneider Electric does not grant any right or license for the personal and noncommercial use of the document or its content, except for a non-exclusive license to consult it on an "as is" basis, at your own risk. All other rights are reserved.

All pertinent state, regional, and local safety regulations must be observed when installing and using this product. For reasons of safety and to help ensure compliance with documented system data, only the manufacturer should perform repairs to components.

When devices are used for applications with technical safety requirements, the relevant instructions must be followed.

Failure to use Schneider Electric software or approved software with our hardware products may result in injury, harm, or improper operating results.

Failure to observe this information can result in injury or equipment damage.

© 2020 Schneider Electric. All rights reserved.

---

# Table of Contents

---



	<b>Safety Information</b> .....	<b>5</b>
	<b>About the Book</b> .....	<b>7</b>
<b>Chapter 1</b>	<b>Introduction</b> .....	<b>11</b>
	Device Overview .....	<b>12</b>
	Front View and Side View .....	<b>13</b>
	Nameplate .....	<b>14</b>
	Type Code .....	<b>15</b>
<b>Chapter 2</b>	<b>Technical Data</b> .....	<b>17</b>
	Environmental Conditions .....	<b>18</b>
	Mechanical Characteristics .....	<b>20</b>
	Electrical Characteristics .....	<b>21</b>
	Timing Data .....	<b>23</b>
	Data Functional Safety .....	<b>24</b>
<b>Chapter 3</b>	<b>Engineering</b> .....	<b>27</b>
	Electromagnetic Compatibility (EMC) .....	<b>28</b>
	Basic Principles of Operation .....	<b>29</b>
	Safety-Related Inputs .....	<b>32</b>
	Synchronization of Safety-Related Inputs .....	<b>34</b>
	Dynamization .....	<b>35</b>
	Signal Interlock Monitoring .....	<b>36</b>
<b>Chapter 4</b>	<b>Installation</b> .....	<b>37</b>
	Prerequisites and Requirements .....	<b>38</b>
	Mechanical Installation .....	<b>39</b>
	Electrical Installation .....	<b>40</b>
<b>Chapter 5</b>	<b>Functions</b> .....	<b>43</b>
	Application Functions .....	<b>44</b>
	Start Functions .....	<b>51</b>
<b>Chapter 6</b>	<b>Configuration and Commissioning</b> .....	<b>55</b>
	Configuration .....	<b>56</b>
	Commissioning .....	<b>57</b>
<b>Chapter 7</b>	<b>Diagnostics</b> .....	<b>59</b>
	Diagnostics via LEDs .....	<b>60</b>
	Diagnostics via Status Output Z1 .....	<b>62</b>
<b>Chapter 8</b>	<b>Accessories, Service, Maintenance, and Disposal</b> .....	<b>65</b>
	Accessories .....	<b>66</b>
	Maintenance .....	<b>67</b>
	Transportation, Storage, and Disposal .....	<b>68</b>
	Service Addresses .....	<b>69</b>
<b>Index</b>	.....	<b>71</b>

---



## Important Information

### NOTICE

Read these instructions carefully, and look at the equipment to become familiar with the device before trying to install, operate, service, or maintain it. The following special messages may appear throughout this documentation or on the equipment to warn of potential hazards or to call attention to information that clarifies or simplifies a procedure.



The addition of this symbol to a “Danger” or “Warning” safety label indicates that an electrical hazard exists which will result in personal injury if the instructions are not followed.



This is the safety alert symbol. It is used to alert you to potential personal injury hazards. Obey all safety messages that follow this symbol to avoid possible injury or death.

### **DANGER**

**DANGER** indicates a hazardous situation which, if not avoided, **will result in** death or serious injury.

### **WARNING**

**WARNING** indicates a hazardous situation which, if not avoided, **could result in** death or serious injury.

### **CAUTION**

**CAUTION** indicates a hazardous situation which, if not avoided, **could result in** minor or moderate injury.

### **NOTICE**

**NOTICE** is used to address practices not related to physical injury.

### PLEASE NOTE

Electrical equipment should be installed, operated, serviced, and maintained only by qualified personnel. No responsibility is assumed by Schneider Electric for any consequences arising out of the use of this material.

A qualified person is one who has skills and knowledge related to the construction and operation of electrical equipment and its installation, and has received safety training to recognize and avoid the hazards involved.

### QUALIFICATION OF PERSONNEL

Only appropriately trained persons who are familiar with and understand the contents of this manual and all other pertinent product documentation as well as all documentation of all components and equipment of the machine/process are authorized to work on and with this product.

The qualified person must be a certified expert in safety engineering.

The qualified person must be able to detect possible hazards that may arise from parameterization, modifying configurations, settings, and wiring, and generally from mechanical, electrical, or electronic equipment. The qualified person must be able to understand the effects that modifications to configurations, settings, and wiring may have on the safety of the machine/process.

---

The qualified person must be familiar with and understand the contents of the risk assessment as per ISO 12100-1 and/or any other equivalent assessment as well as all documents related to such risk assessment or equivalent assessments for the machine/process.

The qualified person must be familiar with the standards, provisions, and regulations for the prevention of industrial accidents, which they must observe when designing, implementing, and maintaining the machine/process.

The qualified person must be thoroughly familiar with the safety-related applications and the non-safety-related applications used to operate the machine/process.

## INTENDED USE

This product described in the present document is a safety module intended to perform safety-related functions in a machine/process according to the present document, to the specified related documents, and to all other documentation of the components and equipment of the machine/process.

The product may only be used in compliance with all applicable safety regulations and directives, the specified requirements and the technical data.

Prior to using the product, you must perform a risk assessment as per ISO 12100-1 in view of the planned application. Based on the results of the risk assessment, the appropriate safety-related measures must be implemented.

Since the product is used as a component in an overall machine or process, you must ensure the safety of persons by means of the design of this overall machine or process.

Operate the product only with the specified cables and accessories. Use only genuine accessories.

Any use other than the use explicitly permitted is prohibited and can result in hazards.

# About the Book



## At a Glance

### Document Scope

This manual describes technical characteristics, installation, commissioning, operation and maintenance of the safety module XPSUAF.

### Validity Note

The present document is valid for the products listed in the type code (*see page 15*).

For product compliance and environmental information (RoHS, REACH, PEP, EOLI, etc.), go to [www.schneider-electric.com/green-premium](http://www.schneider-electric.com/green-premium).

The technical characteristics of the devices described in the present document also appear online. To access the information online, go to the Schneider Electric home page <https://www.se.com/ww/en/download/>.

The characteristics that are described in the present document should be the same as those characteristics that appear online. In line with our policy of constant improvement, we may revise content over time to improve clarity and accuracy. If you see a difference between the document and online information, use the online information as your reference.

### Related Documents

Title of documentation	Reference number
XPSUAF	EIO0000003465 (ENG) EIO0000003466 (FRE) EIO0000003467 (GER) EIO0000003468 (ITA) EIO0000003469 (SPA) EIO0000003472 (CHS)
XPSUAF Instruction Sheet	PHA71842 (ENG, FRE, GER, ITA, SPA, CHS)
XPSUAF Instruction Sheet	PHA71843 (ENG, JAP, KOR, POR, RUS, TUR)
XPSUEP User Guide	EIO0000003509 (ENG) EIO0000003510 (FRE) EIO0000003511 (GER) EIO0000003512 (ITA) EIO0000003513 (SPA) EIO0000003516 (CHS)
XPSUEP Instruction Sheet	PHA71854 (ENG, FRE, GER, ITA, SPA, CHS)
XPSUEP Instruction Sheet	PHA71855 (ENG, JAP, KOR, POR, RUS, TUR)
PreventaSupport Library Guide	EIO0000003835 (ENG)

You can download these technical publications and other technical information from our website at [www.schneider-electric.com/en/download](http://www.schneider-electric.com/en/download).

**⚠ DANGER**

**HAZARD OF ELECTRIC SHOCK, EXPLOSION OR ARC FLASH**

- Disconnect all power from all equipment including connected devices prior to removing any covers or doors, or installing or removing any accessories, hardware, cables, or wires except under the specific conditions specified in the appropriate hardware guide for this equipment.
- Always use a properly rated voltage sensing device to confirm the power is off where and when indicated.
- Where 24 Vdc or Vac is indicated, use PELV power supplies conforming to IEC 60204-1.
- Replace and secure all covers, accessories, hardware, cables, and wires and confirm that a proper ground connection exists before applying power to this equipment.
- Use only the specified voltage when operating this equipment and any associated products.

**Failure to follow these instructions will result in death or serious injury.**

This equipment has been designed to operate outside of any hazardous location. Only install this equipment in zones known to be free of a hazardous atmosphere.

**⚠ DANGER**

**POTENTIAL FOR EXPLOSION**

Install and use this equipment in non-hazardous locations only.

**Failure to follow these instructions will result in death or serious injury.**

**⚠ WARNING**

**LOSS OF CONTROL**

- The designer of any control scheme must consider the potential failure modes of control paths and, for certain critical control functions, provide a means to achieve a safe state during and after a path failure. Examples of critical control functions are emergency stop and overtravel stop, power outage and restart.
- Separate or redundant control paths must be provided for critical control functions.
- System control paths may include communication links. Consideration must be given to the implications of unanticipated transmission delays or failures of the link.
- Observe all accident prevention regulations and local safety guidelines.<sup>1</sup>
- Each implementation of this equipment must be individually and thoroughly tested for proper operation before being placed into service.

**Failure to follow these instructions can result in death, serious injury, or equipment damage.**

<sup>1</sup> For additional information, refer to NEMA ICS 1.1 (latest edition), "Safety Guidelines for the Application, Installation, and Maintenance of Solid State Control" and to NEMA ICS 7.1 (latest edition), "Safety Standards for Construction and Guide for Selection, Installation and Operation of Adjustable-Speed Drive Systems" or their equivalent governing your particular location.



## WARNING

### INSUFFICIENT AND/OR INEFFECTIVE SAFETY-RELATED FUNCTIONS

- Verify that a risk assessment as per ISO 12100 and/or other equivalent assessment has been performed before this product is used.
- Before performing any type of work on or with this product, fully read and understand all pertinent manuals.
- Verify that modifications do not compromise or reduce the Safety Integrity Level (SIL), Performance Level (PL) and/or any other safety-related requirements and capabilities defined for your machine/process.
- After modifications of any type whatsoever, restart the machine/process and verify the correct operation and effectiveness of all functions by performing comprehensive tests for all operating states, the defined safe state, and all potential error situations.

**Failure to follow these instructions can result in death, serious injury, or equipment damage.**

### Terminology Derived from Standards

The technical terms, terminology, symbols and the corresponding descriptions in this manual, or that appear in or on the products themselves, are generally derived from the terms or definitions of international standards.

In the area of functional safety systems, drives and general automation, this may include, but is not limited to, terms such as *safety*, *safety function*, *safe state*, *fault*, *fault reset*, *malfunction*, *failure*, *error*, *error message*, *dangerous*, etc.

Among others, these standards include:

Standard	Description
IEC 61131-2:2007	Programmable controllers, part 2: Equipment requirements and tests.
ISO 13849-1:2015	Safety of machinery: Safety related parts of control systems. General principles for design.
EN 61496-1:2013	Safety of machinery: Electro-sensitive protective equipment. Part 1: General requirements and tests.
ISO 12100:2010	Safety of machinery - General principles for design - Risk assessment and risk reduction
EN 60204-1:2006	Safety of machinery - Electrical equipment of machines - Part 1: General requirements
ISO 14119:2013	Safety of machinery - Interlocking devices associated with guards - Principles for design and selection
ISO 13850:2015	Safety of machinery - Emergency stop - Principles for design
IEC 62061:2015	Safety of machinery - Functional safety of safety-related electrical, electronic, and electronic programmable control systems
IEC 61508-1:2010	Functional safety of electrical/electronic/programmable electronic safety-related systems: General requirements.
IEC 61508-2:2010	Functional safety of electrical/electronic/programmable electronic safety-related systems: Requirements for electrical/electronic/programmable electronic safety-related systems.
IEC 61508-3:2010	Functional safety of electrical/electronic/programmable electronic safety-related systems: Software requirements.
IEC 61784-3:2016	Industrial communication networks - Profiles - Part 3: Functional safety fieldbuses - General rules and profile definitions.
2006/42/EC	Machinery Directive
2014/30/EU	Electromagnetic Compatibility Directive
2014/35/EU	Low Voltage Directive

In addition, terms used in the present document may tangentially be used as they are derived from other standards such as:

Standard	Description
IEC 60034 series	Rotating electrical machines
IEC 61800 series	Adjustable speed electrical power drive systems

---

Standard	Description
IEC 61158 series	Digital data communications for measurement and control – Fieldbus for use in industrial control systems

Finally, the term *zone of operation* may be used in conjunction with the description of specific hazards, and is defined as it is for a *hazard zone* or *danger zone* in the *Machinery Directive (2006/42/EC)* and *ISO 12100:2010*.

---

# Chapter 1

## Introduction

---

### What Is in This Chapter?

This chapter contains the following topics:

Topic	Page
Device Overview	12
Front View and Side View	13
Nameplate	14
Type Code	15

## Device Overview

### Outline

The device is a safety module for interruption of safety-related electrical circuits.

The device provides application functions used to monitor signals from different types of sensors/devices.

Equipment with the following types of outputs can be connected to the safety-related inputs of the device:

- NO, NC, C/O, for example, Emergency Stop push-buttons, guard door switches, coded magnetic switches
- PNP transistors, for example, magnetic switches, proximity switches
- OSSD, for example, light curtains

The device is available in four different types: either spring terminals or screw terminals and either 24 Vac/Vdc supply voltage or 48 ... 240 Vac/Vdc supply voltage.

Feature summary:

- 6 application functions
- Configurable start function
- 2 safety-related inputs
- 3 safety-related relay outputs
- 1 non-safety-related status/diagnostics output
- 1 non-safety-related start input with 8 selectable start functions
- Connector for connection of extension module XPSUEP to increase the number of safety-related outputs by 6

## Front View and Side View

### Front View and Side View

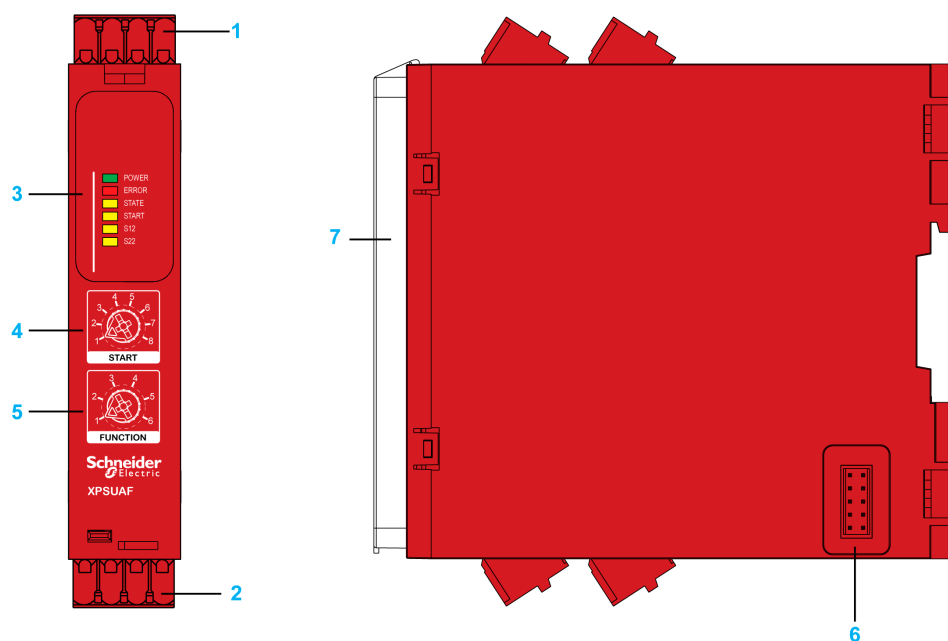

- 1 Removable terminal blocks, top
- 2 Removable terminal blocks, bottom
- 3 LED indicators
- 4 Start function selector
- 5 Application function selector
- 6 Connector for optional output extension module XPSUEP (lateral)
- 7 Sealable transparent cover

## Nameplate

### Nameplate

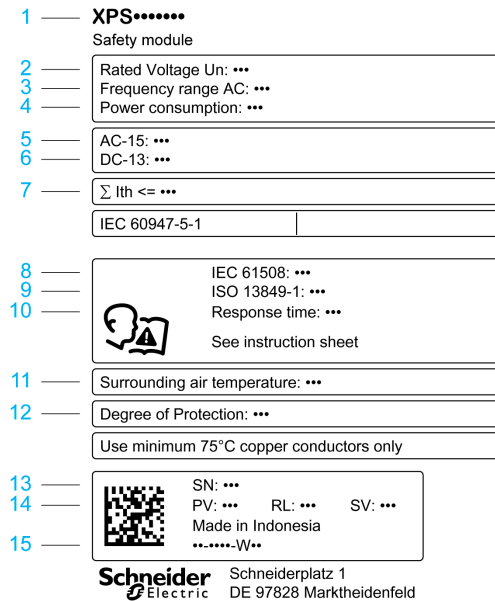

The nameplate contains the following data:

- 1 Device type (refer to chapter Type Code (*see page 15*))
- 2 Nominal voltage
- 3 Frequency range Vac supply
- 4 Input power
- 5 Maximum current of safety-related outputs with utilization category AC15 (250 Vac)
- 6 Maximum current of safety-related outputs with utilization category DC13 (24 Vdc)
- 7 Maximum total thermal current
- 8 Maximum Safety Integrity Level (SIL) as per IEC 61508-1:2010
- 9 Maximum Performance Level and Category as per ISO 13849-1:2015
- 10 Maximum response time to request at safety-related input
- 11 Permissible ambient temperature range during operation
- 12 IP degree of protection
- 13 Serial number
- 14 Product version (PV), release (RL), software version (SV)
- 15 Plant code and date of manufacture (example: PP-2019-W10 means plant code PP, year of manufacture 2019, week of manufacture 10)

## Type Code

### Type Code

Item	1	2	3	4	5	6	7	8	9	10
Type code (example)	X	P	S	U	A	F	1	3	A	C

Item	Meaning
1 ... 4	<b>Product range</b> XPSU = Universal
5 ... 6	<b>Product version</b> AF
7	<b>Supply voltage</b> 1 = 24 Vac/Vdc 3 = 48 ... 240 Vac/Vdc
8 ... 9	<b>Number of safety-related outputs</b> 3A = 3 normally open relay contacts
10	<b>Terminal type</b> C = Spring terminals, removable P = Screw terminals, removable

If you have questions concerning the type code, contact your Schneider Electric service representative.





---

# Chapter 2

## Technical Data

---

### What Is in This Chapter?

This chapter contains the following topics:

Topic	Page
Environmental Conditions	18
Mechanical Characteristics	20
Electrical Characteristics	21
Timing Data	23
Data Functional Safety	24

## Environmental Conditions

### Environmental Conditions For Storage

The device complies with class 1K5 as per IEC 60721-3-1:1997 (climatic conditions):

Characteristic	Value
Ambient temperature	-40 ... 70 °C (-40 ... 158 °F)
Rate of change of temperature	1 °C/min (1.8 °F/min)
Ambient humidity	10 ... 100 % relative humidity

The device complies with class 1M2 as per IEC 60721-3-1:1997 (mechanical conditions):

Characteristic	Value
Vibration, sinusoidal, displacement amplitude 2 ... 9 Hz	1.5 mm
Vibration, sinusoidal, acceleration amplitude 9 ... 200 Hz	5 m/s <sup>2</sup>
Shock, shock response spectrum type L, peak acceleration	40 m/s <sup>2</sup>

### Environmental Conditions For Transportation

The device complies with class 2K5H as per IEC 60721-3-2:1997 (climatic conditions):

Characteristic	Value
Ambient temperature	-25 ... 85 °C (-13 ... 185 °F)
Change of temperature, air/air	-25 ... 30 °C (-13 ... 86 °F)
Ambient humidity	5 ... 95 % relative humidity, no condensation

The device complies with class 2M2 as per IEC 60721-3-2:1997 (mechanical conditions):

Characteristic	Value
Vibration, sinusoidal, displacement amplitude 2 ... 9 Hz	3.5 mm
Vibration, sinusoidal, acceleration amplitude 9 ... 200 Hz	10 m/s <sup>2</sup>
Vibration, sinusoidal, acceleration amplitude 200 ... 500 Hz	15 m/s <sup>2</sup>
Shock, shock response spectrum type I, peak acceleration	100 m/s <sup>2</sup>
Shock, shock response spectrum type II, peak acceleration	300 m/s <sup>2</sup>

### Environmental Conditions For Operation

Characteristic	Value
Maximum installation altitude above mean sea level	2000 m (6562 ft)
Installation required in control cabinet/enclosure with degree of protection	IP54

The device complies with class 3K5 and special class 3Z11 as per IEC 60721-3-3:2008 (climatic conditions):

Characteristic	Value
Ambient temperature	-25 ... 55 °C (-13 ... 131 °F), no icing
Rate of change of temperature	0.5 °C/min (0.9 °F/min)
Ambient humidity	5 ... 95 % relative humidity, no condensation

The device complies with class 3M4 as per IEC 60721-3-3:2008 (mechanical conditions):

Characteristic	Value
Vibration, sinusoidal, displacement amplitude 2 ... 9 Hz	3 mm
Vibration, sinusoidal, acceleration amplitude 9 ... 200 Hz	10 m/s <sup>2</sup>
Shock, shock pulse shape: half-sine, peak acceleration	100 m/s <sup>2</sup>

The devices complies with the following vibration and shock values as per IEC 60947-1:

Characteristic	Value
Vibration, sinusoidal, displacement amplitude 2 ... 13 Hz	1 mm
Vibration, sinusoidal, acceleration amplitude 13.2 ... 100 Hz	7 m/s <sup>2</sup>
Shock, shock pulse shape: half-sine, peak acceleration	150 m/s <sup>2</sup>

## Mechanical Characteristics

### Dimensions

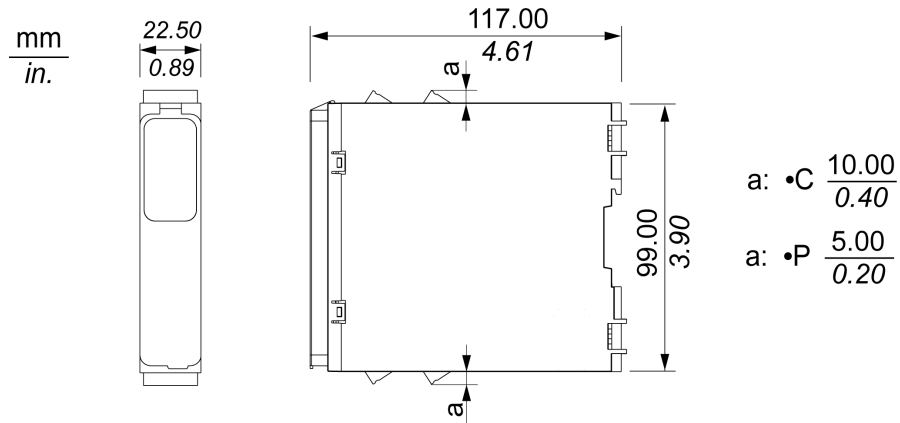

Characteristic	Value	
	XPSUAF...C	XPSUAF...P
Width	22.5 mm (0.89 in)	
Height without terminals	99 mm (3.90 in)	
Height with terminals	119 mm (4.70 in)	109 mm (4.30 in)
Depth	117 mm (4.61 in)	

### Weight

Characteristic	Value
Weight	0.2 kg (0.44 lbs)

### Degree Of Protection

Characteristic	Value
Housing	IP40
Terminals	IP20

### Wire Cross Sections, Stripping Lengths, and Tightening Torques

Characteristic	Value
Stripping length for spring terminals	12 mm (0.47 in)
Stripping length for screw terminals	7 ... 8 mm (0.28 ... 0.31 in)
Wire cross section, single wire without wire ferrule <sup>(1)</sup>	0.2 ... 2.5 mm <sup>2</sup> (AWG 24 ... 12)
Wire cross section, single wire with wire ferrule	0.25 ... 2.5 mm <sup>2</sup> (AWG 24 ... 12)
Wire cross section, two wires without wire ferrule <sup>(1)</sup>	0.2 ... 1.5 mm <sup>2</sup> (AWG 24 ... 16)
Wire cross section, two wires with uninsulated wire ferrule	0.25 ... 1 mm <sup>2</sup> (AWG 24 ... 18)
Wire cross section, two wires with insulated wire ferrule	0.5 ... 1.5 mm <sup>2</sup> (AWG 20 ... 16)
Tightening torque for screw terminals	0.5 ... 0.6 N m (4.4 ... 5.3 lb in)
<b>(1)</b> Stranded or solid	

## Electrical Characteristics

### Supply

Characteristic	Value	
	XPSUAF1...	XPSUAF3...
Supply voltage AC	24 Vac (-15 ... 10 %)	48 ... 240 Vac (-10 ... 10 %)
Supply voltage DC	24 Vdc (-20 ... 20 %)	48 ... 240 Vdc (-10 ... 10 %)
Nominal input power AC	5 VA (24 Vac)	6.5 VA (240 Vac)
Nominal input power DC	2 W (24 Vdc)	3 W (48 Vdc)
Frequency range AC	50 ... 60 Hz	
Overvoltage category	II	
Pollution degree	2	
Insulation voltage	300 V	
Impulse withstand voltage	4 kV	

### Electromagnetic Compatibility (EMC)

Characteristic	Value	
	XPSUAF1...	XPSUAF3...
Conducted and radiated emissions as per IEC CISPR 11	Group 1/class B	Group 1/class A
Usage in environment as per IEC/UL 60947-1	Environment B	Environment A

### Common Reference Potential

Terminal B2 is provided to obtain a common reference potential for 24 Vdc signals.

### Safety-Related Inputs

Characteristic	Value
Number of inputs, positive supplied (each with 1 control output DC+ (S11, S21) and 1 input CH+ (S12, S22)), single-channel	2
Output voltage at DC+	>15 Vdc
Input voltage at CH+	0 ... 24 Vdc (+20 %)
Switching voltage for activation of CH+	>15 Vdc
Switching voltage for deactivation of CH+	<5 Vdc
Input current	5 mA
Maximum wire resistance	500 Ω

### Start Input

Characteristic	Value
Output voltage at DC+	>15 Vdc
Input voltage at CH+	0 ... 24 Vdc (+20 %)
Switching voltage activate CH+	>15 Vdc
Switching voltage deactivate CH+	<5 Vdc
Input current	5 mA
Maximum wire resistance	500 Ω

### Classification of Safety-Related Inputs and Start Input as per ZVEI CB24I

Representation and values as per identifying key, ZVEI CB24I:

Source/sink	Interface type	Additional measure	Source/sink	Interface type
Sink:	A	M	Source:	C0

Interface type A: Sink		
Parameter	Minimum value	Maximum value
Input current $I_i$ (in the ON state)	3 mA	5 mA
Output voltage $U_i$	15 V	24 V (+20 %)
Additional measure M	The inputs are not types as per IEC 61131-2. TG is S•1 for S•2 TG is Y1 for Y2	>15 Vdc

Refer to Dynamization of Safety-Related Inputs and Start Input (*see page 23*) for test pulse times.

**Safety-Related Outputs**

Characteristic	Value
Number of relay contacts, Normally Open, instantaneous	3
Maximum short circuit current $I_K$	1 kA
Maximum continuous current, Normally Open relay contacts	6 A
Maximum total thermal current $\Sigma I_{th}$ in free air up to 55°C (131 °F) and for side-by-side mounting up to 35°C (95 °F)	12 A
Maximum total thermal current $\Sigma I_{th}$ for side-by-side mounting at 55°C (131°F)	6 A Derating curve (derating starting at 35 °C (95 °F)):
	<p>The graph shows the derating curve for the total thermal current <math>\Sigma I_{th}</math> (A) as a function of temperature. The y-axis ranges from 0 to 14 A, and the x-axis shows <math>T_{min}</math>, 35°C (95°F), and <math>T_{max}</math>. A horizontal dashed line is at 12 A from <math>T_{min}</math> to 35°C. From 35°C, the current decreases linearly to 6 A at <math>T_{max}</math>.</p>
Minimum current	10 mA
Minimum voltage	5 V
Utilization category as per UL 60947-5-1	B300 and R300
Utilization category as per IEC 60947-4-1 and IEC 60947-5-1)	AC1: 250 V AC15: 250 V DC1: 24 V DC13: 24 V
Maximum current, normally open relay contacts	AC1: 5 A AC15: 3 A DC1: 5 A DC13: 3 A
External fusing	10 A, category gG

**Additional Non-Safety-Related Outputs**

Characteristic	Value
Number of semiconductor pulsed outputs	1
Output voltage	24 Vdc
Maximum current	20 mA

## Timing Data

### Maximum Response Times

Characteristic	Value	
	XPSUAF1...	XPSUAF3...
Maximum response time to request at safety-related input	20 ms	
Maximum response time after power outage AC	200 ms	80 ms
Maximum response time after power outage DC	120 ms	80 ms

### Recovery Time

Characteristic	Value
Recovery time after request at safety-related input	200 ms

### Switch-On and Activation Delays

Characteristic	Value
Switch on delay after power on and automatic start	2500 ms
Delay after activation of safety-related input or valid start condition	100 ms

### Monitored Start

Characteristic	Value
Waiting time	2500 ms
Minimum duration of start pulse for monitored start	80 ms

### Dynamization of Safety-Related Inputs and Start Input

Characteristic	Value
Test pulse duration (safety-related input must be activated for longer than duration of test pulse)	2 ms
Test pulse interval	500 ms
Maximum delay of test pulse	40 ms
Test pulse phase shift	At least 70 ms

### Debounce Time of Safety-Related Inputs

Characteristic	Value
Debounce time, standard	2.5 ms
Debounce time, with OSSD	4 ms

### Signal Interlock Monitoring Time

Characteristic	Value
Signal interlock monitoring time	200 ms

### Synchronization Times

The synchronization times for the synchronization of safety-related inputs depend on the application function (*see page 44*).

## Data Functional Safety

### Data Functional Safety

Characteristic	Value	
	XPSUAF1***	XPSUAF3***
Defined safe state	Safety-related outputs are de-energized Normally Open: open	
Maximum Performance Level (PL), Category (as per ISO 13849-1:2015)	PL e, Category 4 Actual PL and category depend on wiring and configuration.	
Maximum Safety Integrity Level (SIL) (as per IEC 61508-1:2010)	3 Actual SIL depends on wiring and configuration.	
Safety Integrity Level Claim Limit (SILCL) (as per IEC 62061:2005+AMD1:2012+AMD2:2015)	3 Actual SILCL depends on wiring and configuration.	
Type (as per IEC 61508-2)	B	
Hardware Fault Tolerance (HFT) (as per IEC 61508 and IEC 62061)	1	
Stop Category for Emergency Stops (as per ISO 13850 and IEC 60204-1)	0	
Lifetime in years at an ambient temperature of 55 °C (131 °F)	20	
Safe Failure Fraction (SFF) (as per IEC 61508 and IEC 62061)	>99 %	
Probability of Dangerous Failure per hour (PFHD) in 1/h (as per IEC 61508 and ISO 13849-1)	1.13 x 10 <sup>-9</sup>	1.61 x 10 <sup>-9</sup>
Mean Time To Dangerous Failure (MTTFd) in years (high as per ISO 13849-1)	>30	
Average Diagnostic Coverage (DC <sub>avg</sub> ) (high as per ISO 13849-1)	≥99 %	
Maximum number of cycles over lifetime	DC13, 24 Vdc 1 A: 1200000 DC13, 24 Vdc 3 A: 180000 AC1, 250 Vac 4 A: 180000 AC15, 250 Vac 1 A: 70000 AC15, 250 Vac 3 A: 39000	

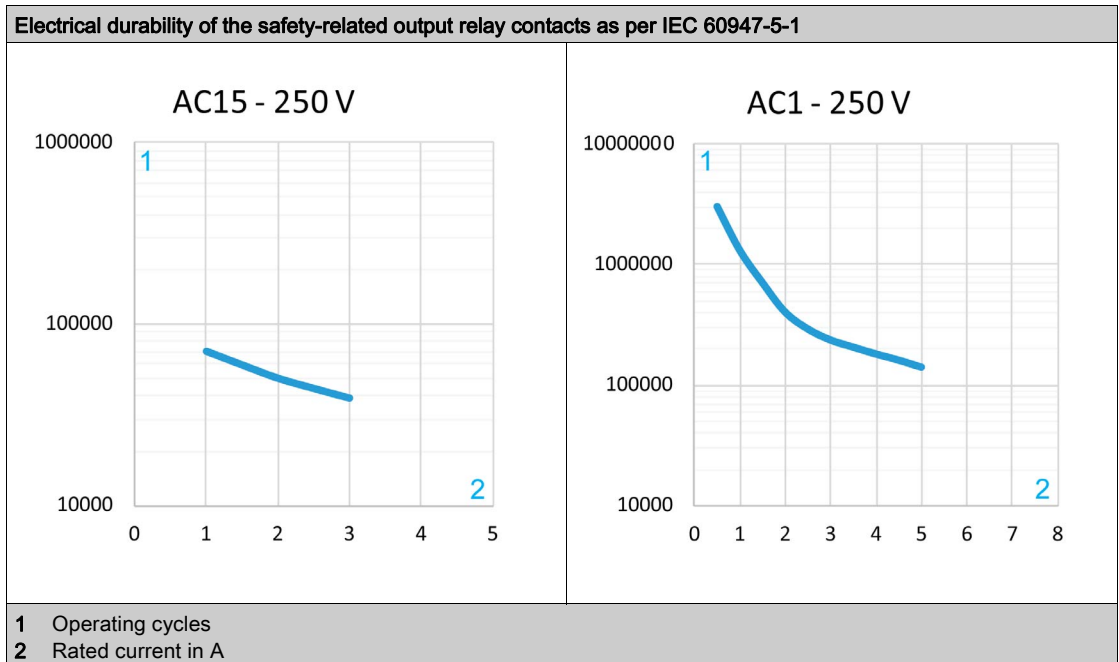



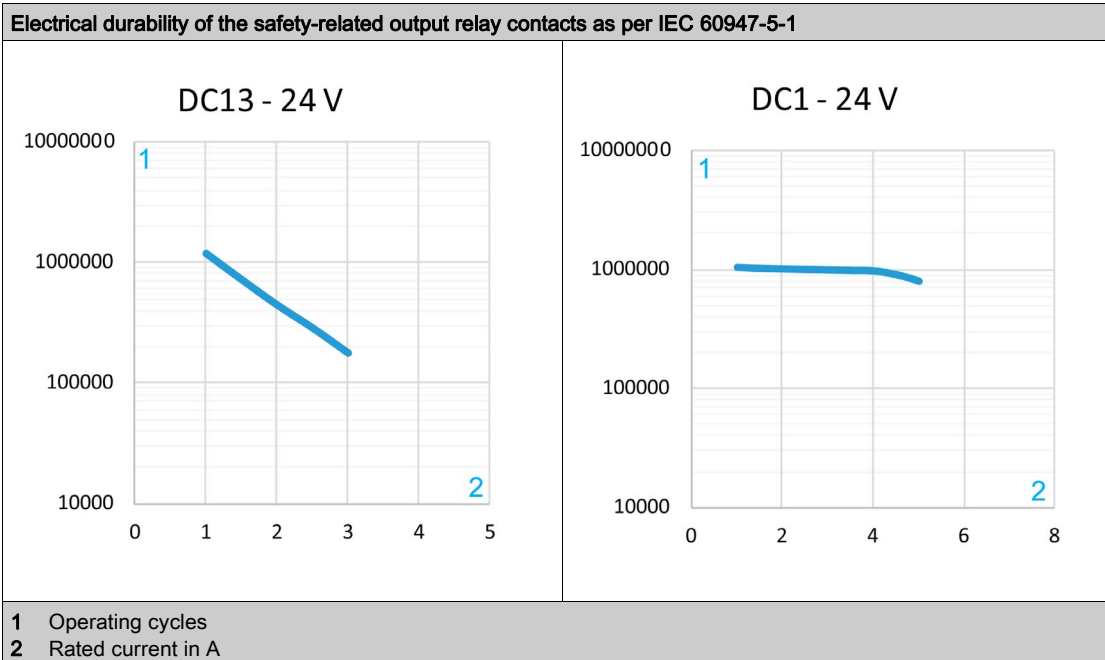

Refer to chapter Timing Data ([see page 23](#)) for additional technical data that may affect your functional safety calculations.



---

# Chapter 3

## Engineering

---

### What Is in This Chapter?

This chapter contains the following topics:

Topic	Page
Electromagnetic Compatibility (EMC)	28
Basic Principles of Operation	29
Safety-Related Inputs	32
Synchronization of Safety-Related Inputs	34
Dynamization	35
Signal Interlock Monitoring	36

## Electromagnetic Compatibility (EMC)

### Conducted and Radiated Electromagnetic Emissions

Equipment of class A as per IEC CISPR 11 is not intended for use in residential environments and may not provide adequate protection to radio reception in such environments.

 <b>WARNING</b>
--

<b>INSUFFICIENT ELECTROMAGNETIC COMPATIBILITY</b>
---

- |  |
|--|
| <ul style="list-style-type: none"><li>● Verify compliance with all EMC regulations and requirements applicable in the country in which the device is to be operated and with all EMC regulations and requirements applicable at the installation site.</li><li>● Do not install and operate devices of class A as per IEC CISPR 11 in residential environments.</li><li>● Implement all required radio interference suppression measures and verify their effectiveness.</li></ul> |
|--|

<b>Failure to follow these instructions can result in death, serious injury, or equipment damage.</b>
---

According to IEC CISPR 11, device type XPSUAF1... is a group 1, class B device. Class B as per IEC CISPR 11 corresponds to environment B as per IEC 60947-1.

According to IEC CISPR 11, device type XPSUAF3... is a group 1, class A device. Class A as per IEC CISPR 11 corresponds to environment A as per IEC 60947-1.

## Basic Principles of Operation

### Introduction

The following sections provide basic information on the principles of operation of the device to assist you in engineering your application function.

### Operating States

The following graphic illustrates the operating states and state transitions of the device:

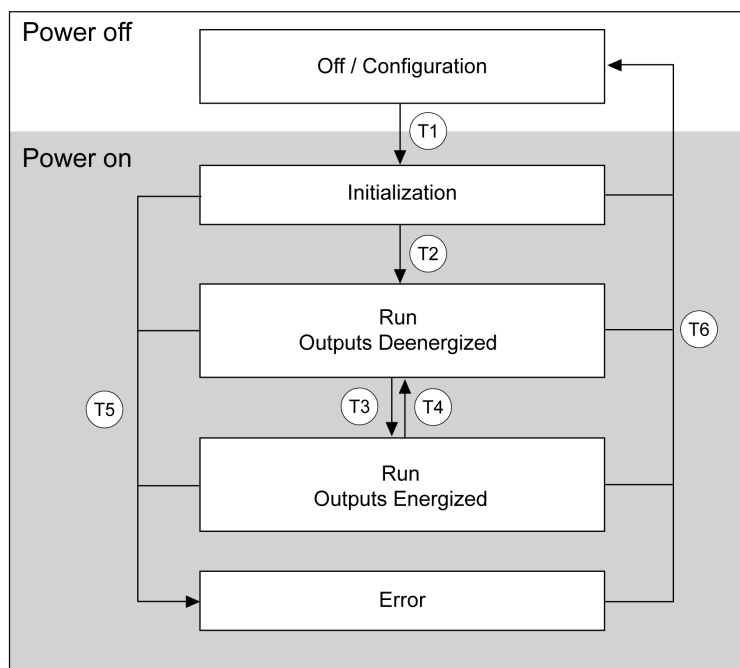

Operating state	Description	In defined safe state
Off / Configuration	Configuration only possible in this operating state	Yes
Initialization	Self-tests	Yes
Run: Outputs Deenergized	Regular operation with safety-related function active	Yes
Run: Outputs Energized	Regular operation with safety-related function not active	No
Error	Error detected	Yes

**NOTE:** See the chapter Data Functional Safety (*see page 24*) for the defined safe state of the device.

### State Transitions

State transition	Condition
T1	<ul style="list-style-type: none"> <li>Power on</li> </ul>
T2	<ul style="list-style-type: none"> <li>Initialization successful</li> <li>Switch on delay has passed</li> </ul>
T3	<ul style="list-style-type: none"> <li>Start condition fulfilled (for example, automatic start or manual start with start button pressed)</li> <li>Safety-related inputs activated</li> <li>For application functions with signal interlock monitoring: no signal interlock condition</li> <li>For application functions with synchronization: synchronization time requirements met</li> </ul>
T4	<ul style="list-style-type: none"> <li>Safety-related inputs deactivated (corresponds to triggering of the safety-related function)</li> </ul>
T5	<ul style="list-style-type: none"> <li>Error detected on</li> </ul>

State transition	Condition
T6	<ul style="list-style-type: none"> <li>Power off</li> </ul>

**NOTE:** Refer to the Activation and Deactivation (*see page 32*) for details on the use of the terms “activated” and “deactivated” in the present document.

### Example with Emergency Stop

The following example uses a machine with an Emergency Stop pushbutton, a start pushbutton for manual start, and a motor to demonstrate the individual operating states and state transitions. The selected application function is Monitoring of Emergency Stop Circuits. The selected start function is Manual Start. The example assumes that the equipment is properly wired and configured.

- After the device is powered on, it enters the operating state Initialization (T1).
- If the initialization is successful, the device enters the operating state Run: Outputs Deenergized (T2). If an error is detected, the device transitions to the operating state Error (T5).
- On entering the operating state Run: Outputs Deenergized, the device verifies the state of the safety-related inputs and of the start input. The motor is at a standstill.
- If the start pushbutton is not pressed, the start input stays deactivated and the device remains in the operating state Run: Outputs Deenergized. The motor is at a standstill. Detailed information on the start functions and the timing can be found in the chapter Start Functions (*see page 51*).
- If the start pushbutton is pressed, the start input is activated, i.e. the start condition is fulfilled. The state of the safety-related inputs determines whether the device transitions to the operating state Run: Outputs Energized.
- If the safety-related inputs are not activated (actuator of Emergency Stop pushbutton pushed down), the device remains in the operating state Run: Outputs Deenergized. The motor remains at a standstill. If the safety-related inputs are activated (actuator of Emergency Stop pushbutton pulled out), the device transitions to the operating state Run: Outputs Energized (T3). The motor runs. This operating corresponds to regular operation of the machine. If an application function with synchronization (*see page 34*) of the safety-related inputs is used, this transition only occurs if the safety-related inputs are activated within the synchronization time.
- In the operating state Run: Outputs Energized, the device monitors the state of the safety-related inputs. If the actuator of the Emergency Stop pushbutton is pushed down (safety-related inputs deactivated), the safety-related outputs are deactivated within the response time (transition T4 to operating state Run: Outputs Deenergized). The device is again in the defined safe state. The motor is stopped. This corresponds to the Emergency Stop condition of the machine.
- To return to the operating state Run: Outputs Energized (T3), the start input and the safety-related inputs need to be activated again (start button pressed and actuator of the Emergency Stop pushbutton pulled out). If an application function with signal interlock monitoring (*see page 36*) is used, this transition only occurs if there is no signal interlock condition. If an application function with synchronization (*see page 34*) of the safety-related inputs is used, this transition only occurs if the safety-related inputs are activated within the synchronization time.

### Timing Diagram for Example with Emergency Stop

The following timing diagram provides an overview of the example with Emergency Stop.

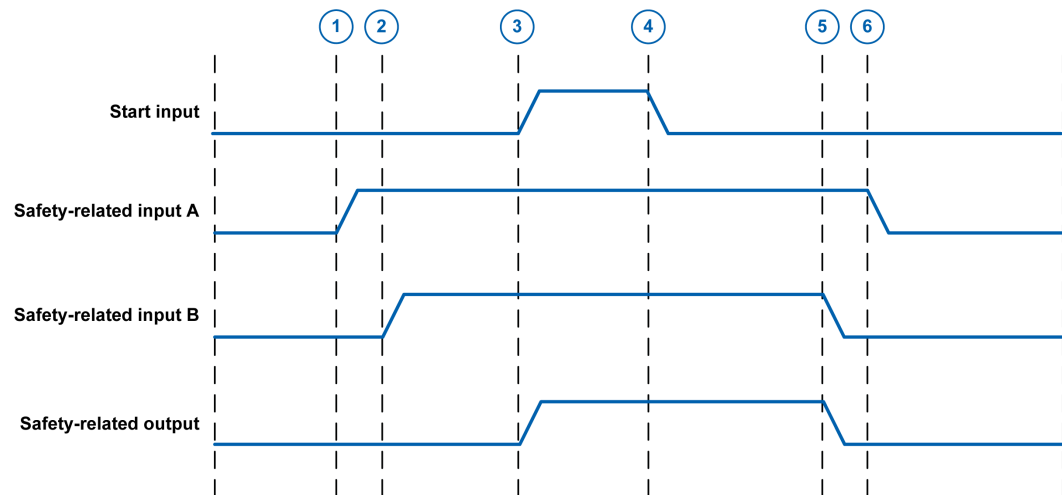

## Legend

Item	Description
1	<ul style="list-style-type: none"> <li>The first safety-related input (A) is activated (actuator of Emergency Stop button pulled out).</li> <li>The device remains in the defined safe state.</li> </ul>
2	<ul style="list-style-type: none"> <li>The second safety-related input (B) is activated (second output contact of Emergency Stop button).</li> <li>If an application function with synchronization (<a href="#">see page 34</a>) is used, the first safety-related output (A) is only activated if the second safety-related input (B) is activated within the synchronization time.</li> <li>The start button has not yet been pressed so the start condition is not yet fulfilled and the device remains in the defined safe state.</li> </ul>
3	<ul style="list-style-type: none"> <li>The start button is pressed.</li> <li>The start condition is fulfilled. See the chapter Start Functions (<a href="#">see page 51</a>) for detailed information on the start functions.</li> <li>The safety-related output is activated within the activation delay time (<a href="#">see page 23</a>).</li> <li>If an application function with synchronization (<a href="#">see page 34</a>) of two input channels is used, the safety-related output is only activated if the two channels of the safety-related input have been activated within the synchronization time.</li> <li>The motor runs. The device is not in the defined safe state.</li> </ul>
4	<ul style="list-style-type: none"> <li>The start button is released.</li> </ul>
5	<ul style="list-style-type: none"> <li>The safety-related input B is deactivated (actuator of Emergency Stop button pushed).</li> <li>The safety-related output is deactivated within the response time (<a href="#">see page 23</a>).</li> <li>The Emergency Stop is triggered. The device is in the defined safe state.</li> </ul>
6	<ul style="list-style-type: none"> <li>The safety-related input A is deactivated (by second output contact of Emergency Stop button).</li> <li>If an application function with signal interlock monitoring (<a href="#">see page 36</a>) is used, both safety-related inputs must be deactivated within the signal interlock monitoring time (between (5) and (6)).</li> </ul>

## Safety-Related Inputs

### Overview

 **WARNING**

**INSUFFICIENT AND/OR INEFFECTIVE SAFETY-RELATED FUNCTIONS**

Only connect a sensor/device to a safety-related input that meets all requirements as per your risk assessment and that complies with all regulations, standards, and process definitions applicable to your machine/process.

**Failure to follow these instructions can result in death, serious injury, or equipment damage.**

The following sections provide basic information on the safety-related inputs such as principle of activation and deactivation as well as antivalent behavior. Refer to the chapters Electrical Characteristics (*see page 21*) and Electrical Installation (*see page 41*) for more details on the safety-related inputs.

### General Information on Activation and Deactivation of Safety-Related Inputs

In the present document, “activation” of a safety-related input means that a safety-related input changes its state so that the device can enter the operating state Run: Outputs Energized.

The term “deactivation” of a safety-related input means that a safety-related input changes its state so that the device enters the operating state Run: Outputs Deenergized.

See Operating States (*see page 29*) for details on the state machine of the device.

### Activation and Deactivation with Antivalent Behavior Between Two Safety-Related Inputs with One Input Channel Each

Depending on the selected application function, the safety-related inputs are configured for antivalent behavior. Antivalent is defined here as a normally open and a normally closed contacts working in synchronization.

For example, for application function 3 (*see page 47*), the signal for input channel S12 is provided by a normally open contact, whereas the signal for input channel S22 is provided by a normally closed contact.

Two safety-related inputs with one input channel each with antivalent behavior (magnetic switch with NO at S12 and NC at S22):

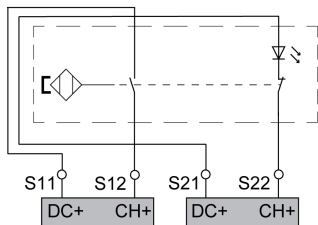

If the level at terminal S12 is logically 0 and the level at terminal S22 is logically 1, the safety-related input is activated,.

Timing diagram for two safety-related inputs with one input channel each with antivalent behavior:

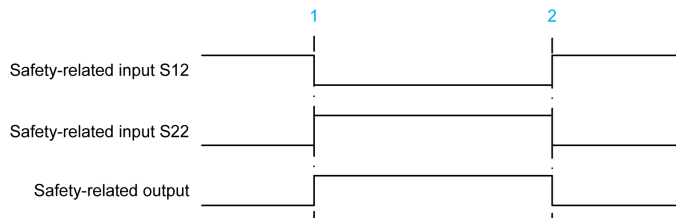

- 1 = Activation, transition to operating state Run: Outputs Energized
- 2 = Deactivation, transition to operating state Run: Outputs Deenergized (defined safe state)



Truth table for two safety-related inputs with one input channel each with antivalent behavior:

Signal State at S12	Signal State at S22	Activation State and Operating State <i>(see page 29)</i>
0	1	Safety-related input channel activated, operating state Run: Outputs Energized
1	0	Safety-related input channel deactivated, operating state Run: Outputs Deenergized

Identical signal states are only permissible within the synchronization time *(see page 34)*. Otherwise, identical signal states trigger an alert.

The truth table applies to the wiring diagrams presented for the application functions.

If the magnetic switch in the wiring example above is used for guard monitoring, this means that the magnetic switch is presented in the activated state and the guard is closed.

Consult the manual of the sensor/device you want to use for your application function for details on signal state required for activation and deactivation as defined in the present document.

## Synchronization of Safety-Related Inputs

### Overview

The device can monitor synchronized behavior of the input channels of the safety-related inputs using various synchronization mechanisms with different synchronization times. If the synchronized input channels of the safety-related inputs are not activated within the synchronization time, the safety-related output or outputs are not activated.

The synchronized terminals of the safety-related inputs and the corresponding synchronization times are listed for each individual application function (*see page 44*) using synchronization.

Refer to the chapter Safety-Related Inputs (*see page 32*) for additional information on the use of the term "activation" in the present document.

## Dynamization

### Dynamization of Inputs

Dynamization is used for cross circuit detection between two safety-related inputs or between one safety-related input and the Start input or a cross-circuit to an external power supply unit or to ground.

Dynamization is implemented by means of periodically generated test pulses at the control outputs of the safety-related inputs S•1 and of the start input Y1.

Whether dynamization of the safety-related inputs is used depends on the selected application function (*see page 43*).

The following diagram illustrates the dynamization principle and timing:

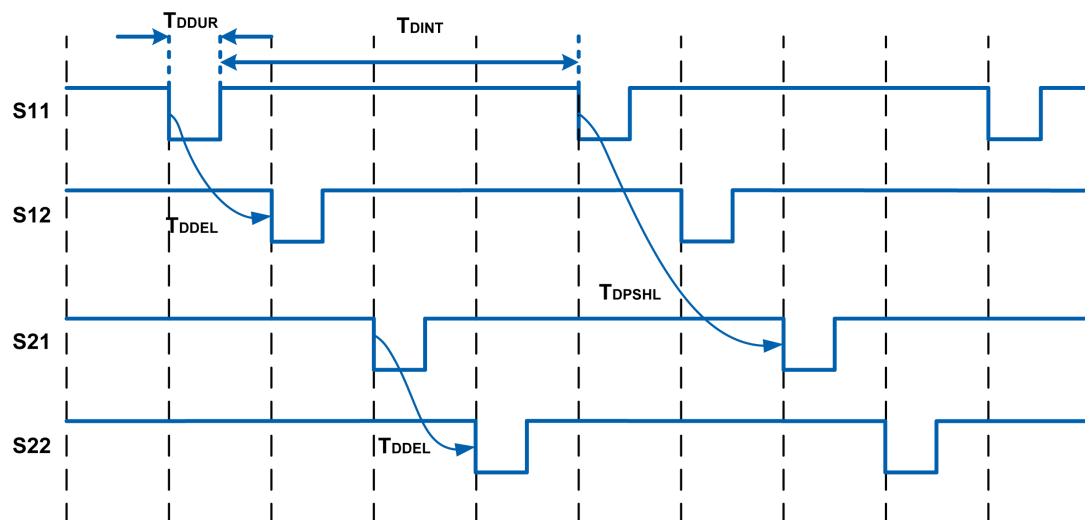

The same logic applies to Y1 and Y2.

Designation	Value	Explanation
$T_{DDUR}$	2 ms	Duration of the test pulse. The duration of the test pulse is the time between the start of the test pulse and the end of the test pulse.
$T_{DINT}$	500 ms	Interval between test pulses. This interval is the time between the start of a test pulse and the start of the next test pulse at the same control output.
$T_{DDEL}$	40 ms	Maximum delay of test pulse. This delay is the maximum time between the start of the test pulse at the control output and the associated input channel, that is, the maximum time during which the input expects to "see" dynamization.
$T_{DPSHL}$	At least 70 ms	Phase shift of test pulses. This time is the phase shift between the test pulses at the control outputs of the safety-related inputs.

## Signal Interlock Monitoring

### Overview

Signal interlock is a monitoring function used to detect conditions in which one of the sensors/devices cannot provide the expected input signal for the device, for example, as a result of contact welding.

The device expects “simultaneous” deactivation of the two safety-related inputs within the signal interlock monitoring time of 200 ms.

If the two monitored safety-related inputs are not deactivated within 200 ms, this is a signal interlock condition and the device triggers a signal interlock alert. The device remains in the defined safe state, i.e., there is no transition from operating state Run: Outputs Deenergized to operating state Run: Outputs Energized (T3).

To exit the signal interlock condition, the two affected safety-related inputs must be deactivated for at least one second. After that, the safety-related inputs can be activated again which activates the safety-related outputs as well.

Signal interlock is available for certain of the application functions (*see page 44*) the device provides.

### Examples

The following figure illustrates a condition without signal interlock:

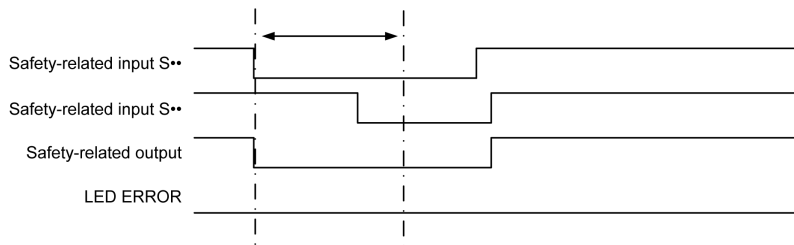

Both safety-related inputs are deactivated within the signal interlock monitoring time of 200 ms. When they are activated again, the safety-related outputs are also activated.

The following figure illustrates a condition with signal interlock:

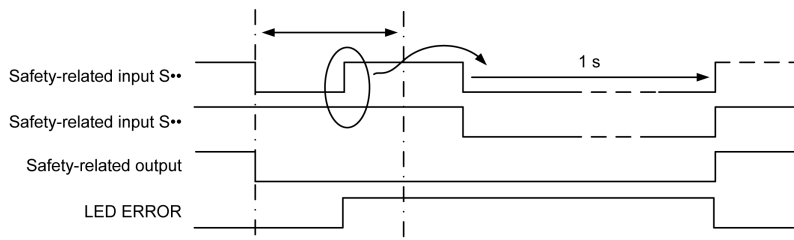

The first safety-related input is deactivated which starts the signal interlock monitoring time of 200 ms. It is then activated again before the second safety-related input is deactivated. This immediately triggers a signal interlock alert even though the 200 ms have not yet elapsed.

The following figure illustrates a condition with signal interlock:

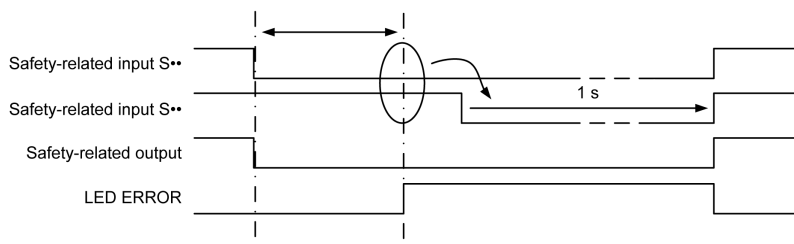

The first safety-related input is deactivated which starts the signal interlock monitoring time of 200 ms. The second safety-related remains activated longer than 200 ms. This triggers a signal interlock alert 200 ms after interlock monitoring has started.

---

# Chapter 4

## Installation

---

### What Is in This Chapter?

This chapter contains the following topics:

Topic	Page
Prerequisites and Requirements	38
Mechanical Installation	39
Electrical Installation	40

## Prerequisites and Requirements

### Inspecting the Device

Damaged products may cause electric shock or unintended equipment operation.

 <b>DANGER</b>
<b>ELECTRIC SHOCK OR UNINTENDED EQUIPMENT OPERATION</b>
<ul style="list-style-type: none"><li>• Do not use damaged products.</li><li>• Keep foreign objects (such as chips, screws or wire clippings) from getting into the product.</li></ul>
<b>Failure to follow these instructions will result in death or serious injury.</b>

Verify the product type by means of the type code (*see page 15*) and the data printed on the device.

### Control Cabinet/Enclosure

Install the device in a control cabinet or enclosure with degree of protection IP54 that is secured by a keyed or tooled locking mechanism.

The ventilation of the control cabinet/enclosure must be sufficient to comply with the specified ambient conditions for the device and the other components operated in the control cabinet/enclosure.

### Label on Extension Module Connector

The connector for connection of the extension module XPSUEP is covered by a label. Do not remove the label from the connector unless you want to connect the extension module XPSUEP.

<b><i>NOTICE</i></b>
<b>INOPERABLE EQUIPMENT</b>
Do not remove the protective label from the extension connector unless you are immediately attaching an extension module.
<b>Failure to follow these instructions can result in equipment damage.</b>

## Mechanical Installation

### Mounting to DIN Rail

The device can be mounted to the following DIN rails as per IEC 60715:

- 35 x 15 mm (1.38 x 0.59 in)
- 35 x 7.5 mm (1.38 x 0.29 in)

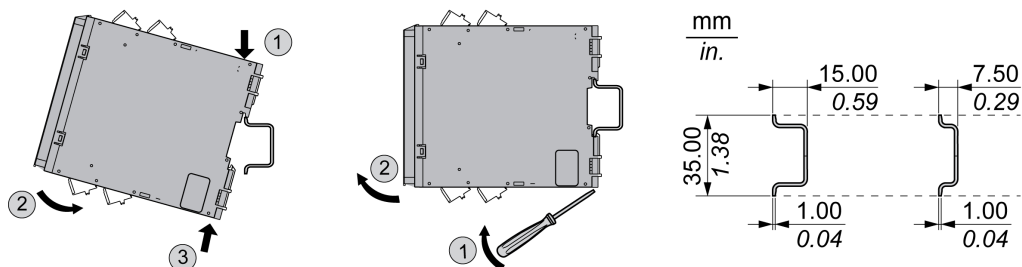

Mounting procedure (left illustration)

Step	Action
1	Slightly tilt the device and hook it onto the DIN rail.
2	Push the lower part of the device towards the DIN rail.
3	Snap in the DIN rail clip.

Dismounting procedure (center illustration)

Step	Action
1	Unlock the DIN rail clip using a screwdriver.
2	Pull the lower part of the device away from the DIN rail and lift the device towards the top to remove it from the DIN rail.

### Screw-Mounting

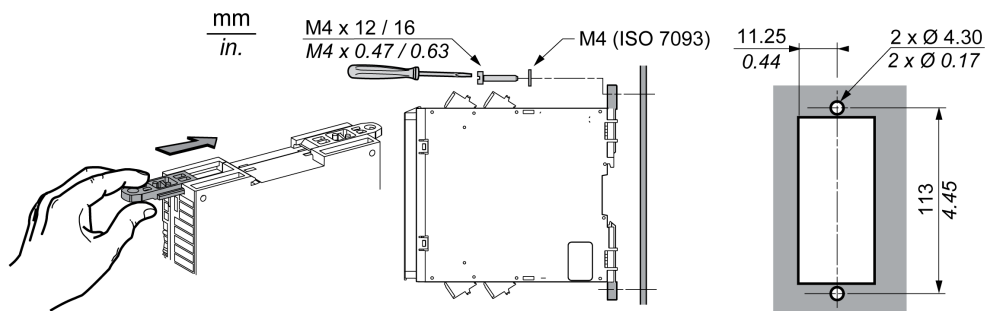

Mounting procedure:

Step	Action
1	Push the additional fastener into the grooves at the device.
2	Prepare the holes.
3	Screw the device to the mounting surface using the specified screws and a washer M4 as per ISO 7093 for each screw.

## Electrical Installation

### General Information

**⚠ DANGER**

**FIRE, ELECTRIC SHOCK OR ARC FLASH**

- Disconnect all power from all equipment of your machine/process prior to electrical installation of the device.
- Confirm the absence of power using a properly rated voltage sensing device.
- Place a "Do Not Turn On" or equivalent hazard label on all power switches and lock them in the non-energized position.

**Failure to follow these instructions will result in death or serious injury.**

Wiring of the device depends on the safety-related function to be implemented. Before wiring the device, engineer the safety-related function, perform a risk assessment with regard to your machine/process, and determine the suitability of the device as well as the connected equipment.

Refer to the Schneider Electric Safety Chain Solutions at <https://www.se.com> for application-specific examples of wiring the device, including the safety-related outputs with feedback and the start input with external start condition.

You can wire the device with the terminal blocks in the device or you can remove the terminal blocks. For the latter, pull the terminal blocks out of the device, connect the individual terminals and push the terminal blocks back into the device.

Use 75 °C (167 °F) copper conductors to wire the device.

### Wire Cross Sections, Stripping Lengths, and Tightening Torques

Characteristic	Value
Stripping length for spring terminals	12 mm (0.47 in)
Stripping length for screw terminals	7 ... 8 mm (0.28 ... 0.31 in)
Wire cross section, single wire without wire ferrule <sup>(1)</sup>	0.2 ... 2.5 mm <sup>2</sup> (AWG 24 ... 12)
Wire cross section, single wire with wire ferrule	0.25 ... 2.5 mm <sup>2</sup> (AWG 24 ... 12)
Wire cross section, two wires without wire ferrule <sup>(1)</sup>	0.2 ... 1.5 mm <sup>2</sup> (AWG 24 ... 16)
Wire cross section, two wires with uninsulated wire ferrule	0.25 ... 1 mm <sup>2</sup> (AWG 24 ... 18)
Wire cross section, two wires with insulated wire ferrule	0.5 ... 1.5 mm <sup>2</sup> (AWG 20 ... 16)
Tightening torque for screw terminals	0.5 ... 0.6 N m (4.4 ... 5.3 lb in)

**(1)** Stranded or solid

### Block Diagram and Terminals

The following drawings present the block diagram and the terminals with their designations in the removable terminal blocks.

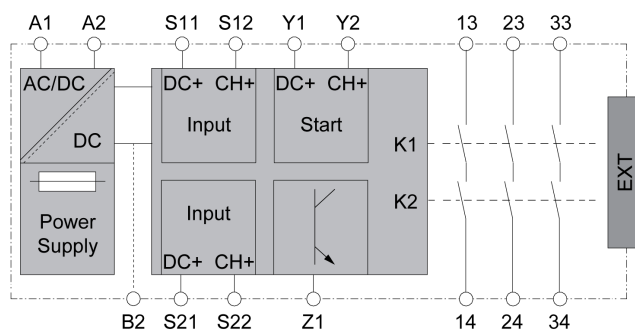



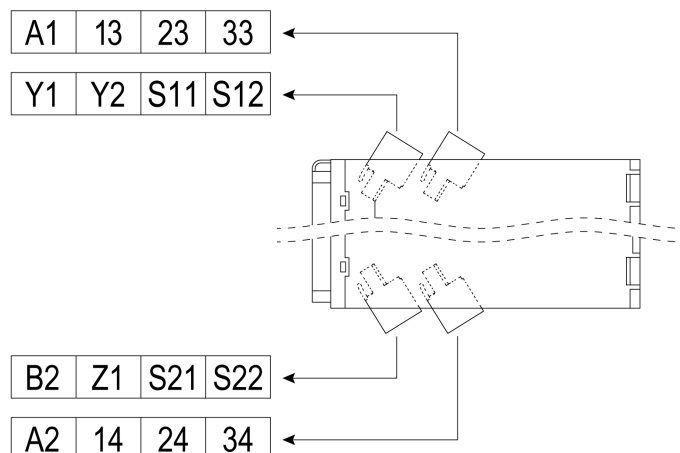

Terminal Designation	Explanation
A1, A2	Power supply
Y1	Control output (DC+) of start input
Y2	Input channel (CH+) of start input
S11, S21	Control outputs (DC+) of safety-related inputs
S12, S22	Input channels (CH+) of safety-related inputs
B2	Terminal for common reference potential for 24 Vdc signals. The power supplies of the connected equipment must have a common reference potential to be connected to this terminal.
13, 14, 23, 24, 33, 34	Terminals of the safety-related outputs
Z1	Pulsed output for diagnostics ( <i>see page 62</i> ), not safety-related
EXT	Connector for output extension module XPSUEP

### Safety-Related Inputs

#### **⚠ WARNING**

##### **INSUFFICIENT AND/OR INEFFECTIVE SAFETY-RELATED FUNCTIONS**

Only connect a sensor/device to a safety-related input that meets all requirements as per your risk assessment and that complies with all regulations, standards, and process definitions applicable to your machine/process.

**Failure to follow these instructions can result in death, serious injury, or equipment damage.**

The device provides two safety-related inputs. Each safety-related input consists of one control output DC+ (terminals S11, S21) and one input channel CH+ (terminals S12, S22).

Each control output DC+ provides a nominal voltage of 24 Vdc to the connected sensor/device. It is also used for dynamization (*see page 35*).

Respect the maximum wire resistance of 500  $\Omega$  when determining the cable length. The maximum wire length between a safety-related input and a sensor/device is 30 m (98.43 ft) if the supply via the control outputs (terminals S•1) of the safety-related inputs are not used.

Wire the terminals of the safety-related inputs according to the wiring diagram for the application function (*see page 44*) to be implemented.

### Safety-Related Outputs

The wiring of the safety-related outputs depends on the safety-related function to be implemented.

Install fuses with the rating specified in the chapter Electrical Characteristics (*see page 22*).

**Start Input**

<b>⚠ WARNING</b>
<p><b>UNINTENDED EQUIPMENT OPERATION</b></p> <ul style="list-style-type: none"> <li>● Do not use the Start function for safety-related purposes.</li> <li>● Use Monitored Start or Startup Test if unintended restart is a hazard according to your risk assessment.</li> </ul> <p><b>Failure to follow these instructions can result in death, serious injury, or equipment damage.</b></p>

The start input consists of one control output DC+ (terminal Y1) and one input channel CH+ (terminal Y2). The control output provides a nominal voltage of 24 Vdc to the connected sensor/device. It is also used for dynamization (*see page 35*).

The wiring of the start input depends on the start function (*see page 51*) to be implemented.

For automatic start, bridge terminals Y1 and Y2 or connect terminal Y2 to an external 24 Vdc power supply.

For manual start or monitored start and if the control output Y1 (DC+) is to be used:

- Connect terminals Y1 and Y2 to the device providing the start signal, such as a push-button.

For manual start or monitored start and if the device providing the start signal is supplied externally:

- Connect terminal Y2 to the device providing the start signal, such as a push-button or a logic controller. Leave terminal Y1 unconnected.

The common reference potential is established via terminal B2.

Respect the maximum wire resistance of 500 Ω when determining the cable length. The maximum wire length between the start input and a sensor/device is 30 m (98.43 ft) if the supply via the control output (terminal Y1) of the start input is not used.

**Additional, Non-Safety-Related Output Z1**

<b>⚠ WARNING</b>
<p><b>INCORRECT USE OF OUTPUT</b></p> <p>Do not use the additional output Z1 for safety-related purposes.</p> <p><b>Failure to follow these instructions can result in death, serious injury, or equipment damage.</b></p>

Connect the semiconductor pulsed output Z1 to a suitable input of the logic controller if you want to use the diagnostics pattern the output provides.

The maximum wire length between the additional output Z1 and connected equipment is 30 m (98.43 ft)

The common reference potential is established via terminal B2.

**Power Supply**

Connect the terminals A1 and A2 to a power supply providing the supply voltage specified for the device in the chapter Electrical Characteristics (*see page 21*).

**Common Reference Potential**

Terminal B2 is provided to obtain a common reference potential for 24 Vdc signals.

The power supplies of the connected equipment must have a common reference potential.

---

# Chapter 5

## Functions

---

### What Is in This Chapter?

This chapter contains the following topics:









Topic	Page
Application Functions	44
Start Functions	51

## Application Functions



### Introduction

The following sections provide an overview of the available application functions and a detailed listing of requirements and values of each of the application functions. The chapter Configuration ([see page 56](#)) describes the configuration procedure by means of the selectors of the device.

### Overview of Application Functions

Typical applications	Type of outputs of sensor/device providing the input signal for application function	Synchronization	Dynamization	Application function selector
 Monitoring of Emergency Stop circuits as per ISO 13850 and IEC 60204-1, stop category 0  Monitoring of guards as per ISO 14119/14120 with electrical switches	Normally open, normally closed and/or changeover outputs	No	Yes	Position 1 <i>(see page 45)</i>
		Yes	Yes	Position 2 <i>(see page 46)</i>
 Monitoring of guards as per ISO 14119/14120 with electrical switches  Monitoring of guards as per ISO 14119/14120 with coded magnetic switches  Monitoring of proximity switches		Yes	Yes	Position 3 <i>(see page 47)</i>
 Monitoring of proximity switches	One PNP output	No	No	Position 4 <i>(see page 48)</i>
		Yes	No	Position 5 <i>(see page 49)</i>
 Monitoring of electro-sensitive protective equipment such as type 4 light curtains as per IEC 61496-1  Monitoring of RFID sensors	OSSD (Output Signal Switching Device) outputs	Yes	No	Position 6 <i>(see page 50)</i>

Application Function 1

Characteristic	Value/Description
Typical applications	 Monitoring of Emergency Stop circuits as per ISO 13850 and IEC 60204-1, stop category 0  Monitoring of guards as per ISO 14119/14120 with electrical switches
Type of outputs of sensor/device providing the input signal for application function	Normally open, normally closed and/or changeover outputs
S• terminals to be connected	S11-S12 and S21-S22
Dynamization	Yes
Signal interlock monitoring	Between terminals S12 and S22
Synchronization of safety-related inputs	No

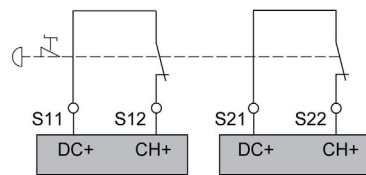

Wiring of the inputs for Emergency Stop

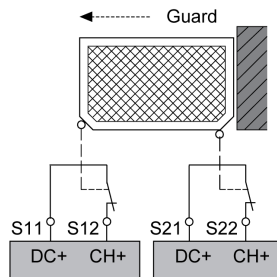

Wiring of the inputs for guards



Application Function 2

Characteristic	Value/Description
Typical applications	 Monitoring of Emergency Stop circuits as per ISO 13850 and IEC 60204-1, stop category 0  Monitoring of guards as per ISO 14119/14120 with electrical switches
Type of outputs of sensor/device providing the input signal for application function	Normally open, normally closed and/or changeover outputs
S• terminals to be connected	S11-S12 and S21-S22
Dynamization	Yes
Signal interlock monitoring	Between terminals S12 and S22

Synchronization:

Synchronized terminals	Synchronization time
S12 synchronized with S22	If S12 is activated before S22, S22 has to be activated within 2 s. If S22 is activated before S12, S12 has to be activated within 4 s.

Wiring of the inputs for Emergency Stop

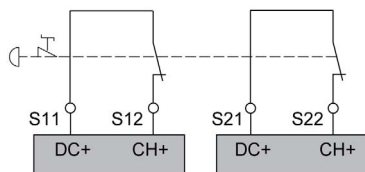

Wiring of the inputs for guards

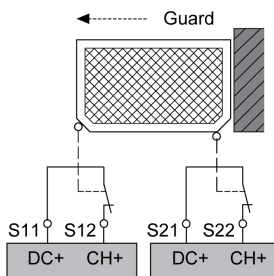

Application Function 3

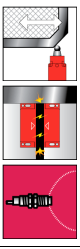
Characteristic	Value/Description
Typical applications	 <p>Monitoring of guards as per ISO 14119/14120 with electrical switches</p> <p>Monitoring of guards as per ISO 14119/14120 with coded magnetic switches</p> <p>Monitoring of proximity switches</p>
Type of outputs of sensor/device providing the input signal for application function	Normally open, normally closed and/or changeover outputs
S• terminals to be connected	S11-S12 and S21-S22
Dynamization	Yes
Signal interlock monitoring	No

Synchronization:

Synchronized terminals	Synchronization time
S12 synchronized with S22	S12 and S22 have to be activated within 0.5 s.

Wiring of the inputs for coded magnetic switches

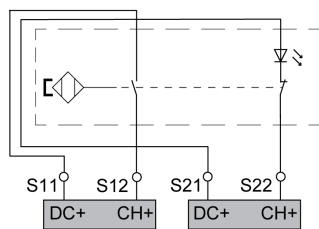

**Application Function 4**

Characteristic	Value/Description
Typical applications	 Monitoring of proximity switches
Type of outputs of sensor/device providing the input signal for application function	One PNP output
S•• terminals to be connected	S12 and S22
Dynamization	No
Signal interlock monitoring	Between terminals S12 and S22
Synchronization of safety-related inputs	No

Wiring of the inputs for sensors/devices with PNP output

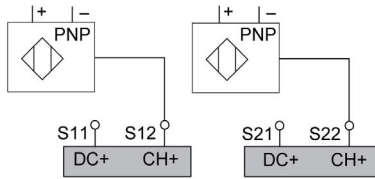



Application Function 5

Characteristic	Value/Description
Typical applications	 Monitoring of proximity switches
Type of outputs of sensor/device providing the input signal for application function	One PNP output
S• terminals to be connected	S12 and S22
Dynamization	No
Signal interlock monitoring	Between terminals S12 and S22

Synchronization:

Synchronized terminals	Synchronization time
S12 synchronized with S22	S12 and S22 have to be activated within 0.5 s.

Wiring of the inputs for sensors/devices with PNP output

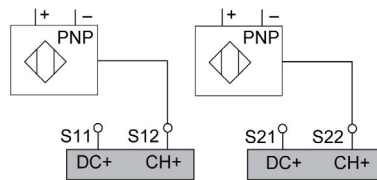

Application Function 6

Characteristic	Value/Description
Typical applications	 Monitoring of electro-sensitive protective equipment such as type 4 light curtains as per IEC 61496-1 Monitoring of RFID sensors
Type of outputs of sensor/device providing the input signal for application function	OSSD (Output Signal Switching Device) outputs
S• terminals to be connected	S12 and S22
Dynamization	No
Signal interlock monitoring	Between terminals S12 and S22

Synchronization:

Synchronized terminals	Synchronization time
S12 synchronized with S22	S12 and S22 have to be activated within 0.5 s.

Wiring of the inputs for sensors/devices with OSSD outputs

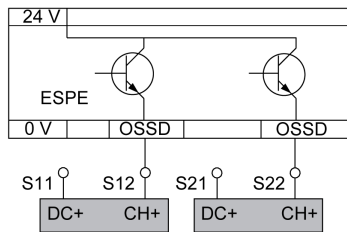

## Start Functions

### Overview

**⚠ WARNING**

**UNINTENDED EQUIPMENT OPERATION**

- Do not use the Start function for safety-related purposes.
- Use Monitored Start or Startup Test if unintended restart is a hazard according to your risk assessment.

**Failure to follow these instructions can result in death, serious injury, or equipment damage.**

The device provides several start functions which are selected by means of the start function selector. The start function determines the start behavior of the device after power-on and for a transition from the operating state Run: Outputs Deenergized (defined safe state) to the operating state Run: Outputs Energized.

The start behavior is configured using the following characteristics:

- Type of start (automatic/manual start and monitored start)
- With or without startup test
- With or without dynamization (*see page 35*)

Refer to the chapter Electrical Installation (*see page 42*) for additional information on wiring the start input.

### Automatic Start

With automatic start, the start input is permanently active. This can be achieved by bridging the start input or providing an external power supply. When the safety-related input is activated, the safety-related outputs are activated within a maximum of 100 ms (activation delay).

The following timing diagram illustrates the automatic start:

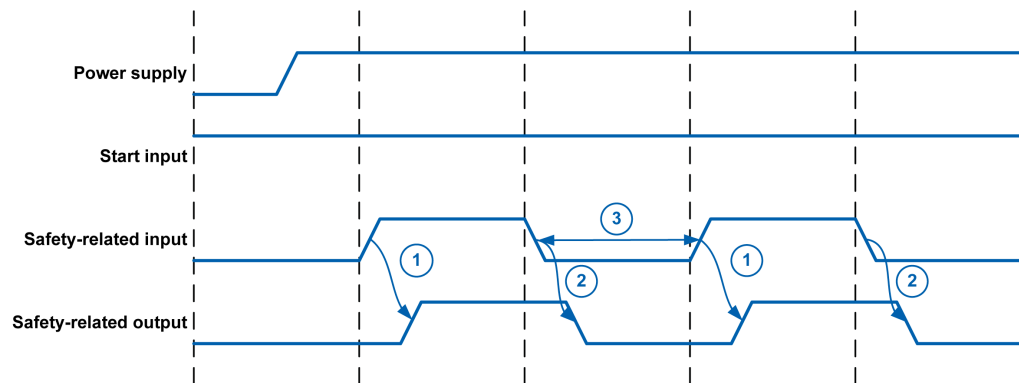

- 1** Activation delay (100 ms): maximum time between activation of safety-related input and activation of safety-related output
- 2** Response time (20 ms): maximum time between deactivation of safety-related input and deactivation of safety-related output
- 3** Recovery time (200 ms): time that must pass before the safety-related input can be activated again

The timing diagram exemplifies the timing using one safety-related input and one safety-related output. The same logic applies in the case of multiple safety-related inputs and/or safety-related outputs.

### Manual Start

A manual start requires the start input to be activated. The safety-related outputs are activated after both the start input and the safety-related inputs have been activated.

The following timing diagram illustrates the manual start:

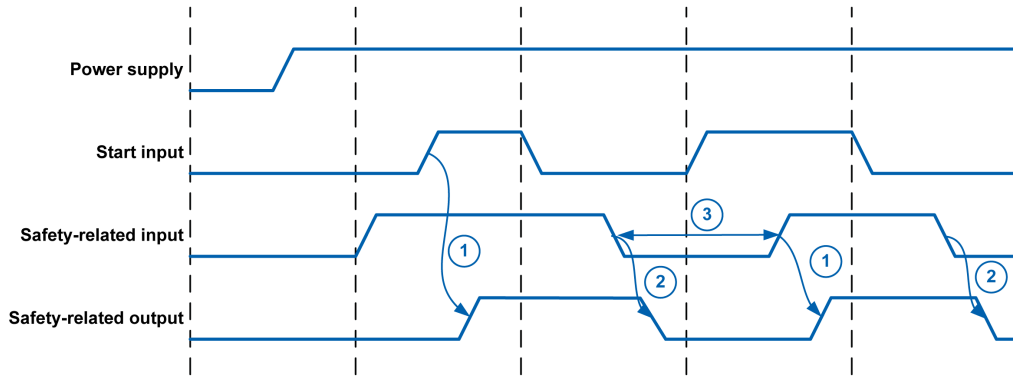

- 1 Activation delay (100 ms): maximum time between activation of start input and activation of safety-related output
- 2 Response time (20 ms): maximum time between deactivation of safety-related input and deactivation of safety-related output
- 3 Recovery time (200 ms): time that must pass before the safety-related input can be activated again

The timing diagram exemplifies the timing using one safety-related input and one safety-related output. The same logic applies in the case of multiple safety-related inputs and/or safety-related outputs.

The signal required for activation of the Start input can be provided, for example, via a push-button, or a logic controller.

### Monitored Start with Falling Edge

In the case of a monitored start with falling edge, the start input must be activated and remain active for a duration of 80 ms. The safety-related outputs are activated with a falling edge of the start input if the safety-related inputs have been activated in the meantime.

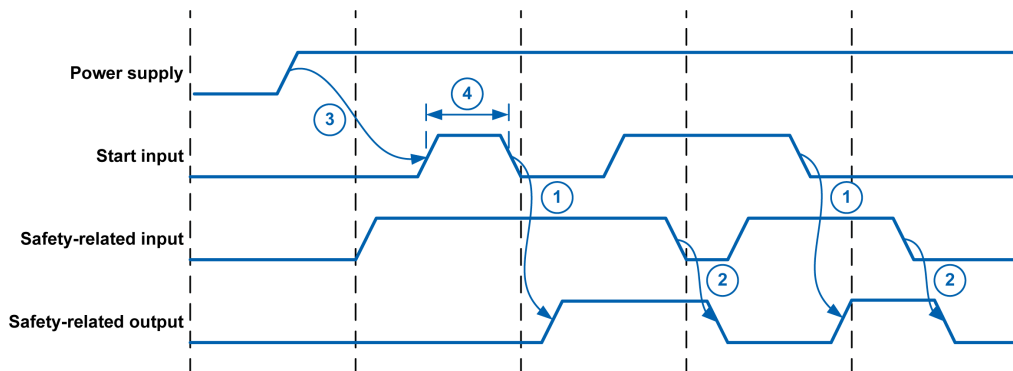

- 1 Activation delay (100 ms): maximum time between deactivation of start input and activation of safety-related output
- 2 Response time (20 ms): maximum time between deactivation of safety-related input and deactivation of safety-related output
- 3 Waiting time after power-on (2500 ms): time that must pass between power-on and activation of the start input
- 4 Minimum duration of start pulse (80 ms): time for which the start input must be activated before the falling edge at the start input

The timing diagram exemplifies the timing using one safety-related input and one safety-related output. The same logic applies in the case of multiple safety-related inputs and/or safety-related outputs.

The signal required for activation of the Start input can be provided, for example, via a push-button or a logic controller.

### Startup Test

The startup test is performed after the device is powered on. The startup test is typically used for applications involving guard monitoring. The start input is permanently activated by, for example, bridging. After power up, the safety-related inputs must be deactivated and activated before the safety-related outputs are activated. This is achieved by, for example, opening and closing the guard.

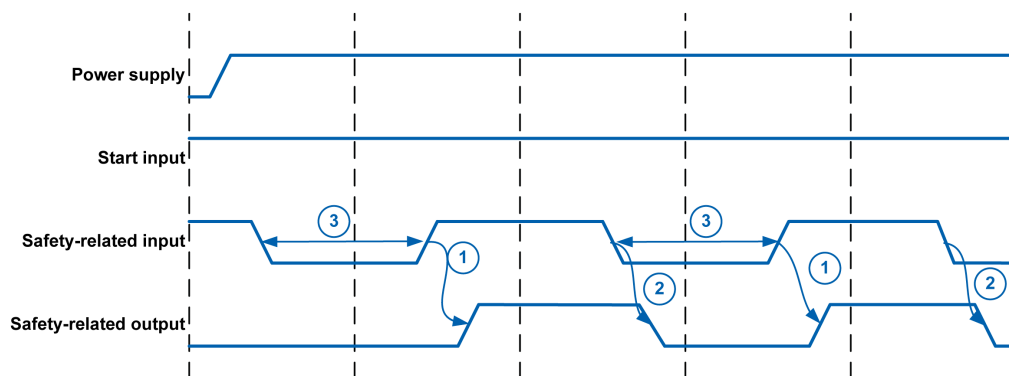

- 1 Activation delay (100 ms): time between activation of safety-related input and activation of safety-related output
- 2 Response time (20 ms): time between deactivation of safety-related input and deactivation of safety-related output
- 3 Recovery time (200 ms): time that must pass before the safety-related input can be activated again

The timing diagram exemplifies the timing using one safety-related input and one safety-related output. The same logic applies in the case of multiple safety-related inputs and/or safety-related outputs.

After power up, the safety-related outputs are not activated before each of the safety-related inputs has been deactivated and activated again, either concurrently or one after the other, regardless of sequence. If the safety-related inputs are already inactive at startup (power cycle), the startup test is considered to have been completed and the safety-related outputs are activated once the safety-related inputs have been activated and the activation delay has passed. If the safety-related inputs are active at power up, they must be deactivated and activated again for the startup test to complete.

### Configuring the Start Function

The start function is configured by means of the start function selector.

Position of start function selector	Configured start function
1	<ul style="list-style-type: none"> <li>● Manual/automatic start (depends on sensor/device connected to start input)</li> <li>● Without startup test</li> <li>● With dynamization</li> </ul>
2	<ul style="list-style-type: none"> <li>● Manual/automatic start (depends on sensor/device connected to start input)</li> <li>● With startup test</li> <li>● With dynamization</li> </ul>
3	<ul style="list-style-type: none"> <li>● Monitored start</li> <li>● Without startup test</li> <li>● With dynamization</li> </ul>
4	<ul style="list-style-type: none"> <li>● Monitored start</li> <li>● With startup test</li> <li>● With dynamization</li> </ul>
5	<ul style="list-style-type: none"> <li>● Manual/automatic start (depends on sensor/device connected to start input)</li> <li>● Without startup test</li> <li>● Without dynamization</li> </ul>
6	<ul style="list-style-type: none"> <li>● Manual/automatic start (depends on sensor/device connected to start input)</li> <li>● With startup test</li> <li>● Without dynamization</li> </ul>
7	<ul style="list-style-type: none"> <li>● Monitored start</li> <li>● Without startup test</li> <li>● Without dynamization</li> </ul>
8	<ul style="list-style-type: none"> <li>● Monitored start</li> <li>● With startup test</li> <li>● Without dynamization</li> </ul>

A start function with dynamization is typically if the start input is connected to a start push-button. A start function without dynamization is typically used if the start input is connected to a logic controller. Refer to the chapter Dynamization ([see page 35](#)) for details.

---

# Chapter 6

## Configuration and Commissioning

---

### What Is in This Chapter?

This chapter contains the following topics:

Topic	Page
Configuration	56
Commissioning	57

## Configuration

### Overview

The device detects certain technically incorrect configurations (for example, a configured start function cannot be used with a configured application function). The device cannot detect unwanted configurations (for example, automatic start has been configured, but a monitored start is required for your application as a result of your risk assessment).

**⚠ WARNING**

**INEFFECTIVE SAFETY-RELATED FUNCTION AND/OR UNINTENDED EQUIPMENT OPERATION**

- Only modify the settings of the selectors of the device if you are fully aware of all effects of such modifications.
- Verify that the settings of the selectors match the intended safety-related function and the corresponding wiring of the device.
- Verify that modifications do not compromise or reduce the Safety Integrity Level (SIL), Performance Level (PL), and/or any other safety-related requirements and capabilities defined for your machine/process.
- Commission the device before it is used for the first time and after each configuration according to the instructions in the present manual and in compliance with all regulations, standards, and process definitions applicable to your machine/process

**Failure to follow these instructions can result in death, serious injury, or equipment damage.**

The device is configured by means of the application function selector and the start function selector. The device must be installed and wired according to the requirements of the safety-related function to be implemented before you can configure it.

Modifications to the positions of the selectors only become effective after power-up. Remove power from the device before modifying the position of the selectors. If the positions of the selectors are modified while power is applied to the device, the device detects a configuration error.

Go through the full commissioning procedure (*see page 57*) after having modified the positions of the selectors.

### Configuration Procedure

Step	Action
1	Verify that the device has been wired according to the safety-related function to be configured.
2	Remove power if the device is not powered off. If an extension module XPSUEP is connected, remove power from the extension module as well.
3	Open the transparent cover of the device.
4	Set the application function selector to the required application function.
5	Set the start function selector to the required start function.
6	Commission the device according to the chapter Commissioning ( <i>see page 57</i> ).



## Commissioning

### Overview

<b>⚠ WARNING</b>
<b>INEFFECTIVE SAFETY-RELATED FUNCTION AND/OR UNINTENDED EQUIPMENT OPERATION</b>
<ul style="list-style-type: none"> <li>• Commission the device before it is used for the first time and after each configuration.</li> <li>• Commission or recommission the machine/process pursuant to all regulations, standards, and process definitions applicable to your machine/process.</li> <li>• Only start the machine/process if there are no persons or obstructions in the zone of operation.</li> <li>• Verify correct operation and effectiveness of all functions by performing comprehensive tests for all operating states, the defined safe state, and all potential error situations.</li> <li>• Document all modifications and the results of the commissioning procedure in compliance with all regulations, standards, and process definitions applicable to your machine/process.</li> </ul>
<b>Failure to follow these instructions can result in death, serious injury, or equipment damage.</b>

### Commissioning Procedure

Step	Action
1	Verify correct mechanical and electrical installation ( <i>see page 37</i> ) according to the intended application.
2	Verify correct configuration ( <i>see page 56</i> ) according to the intended application.
3	Verify that there are no persons or obstructions in the zone of operation.
4	Apply power and start the machine/process. If an extension module XPSUEP is connected, apply power to the extension module at the same time as to the device.
5	Perform comprehensive tests for all operating states, the defined safe state, and all potential error situations.
6	Close the transparent cover of the device and seal it with the enclosed sealing strip. Additional sealing strips are available as an accessory. Refer to the chapter Accessories ( <i>see page 66</i> ) for additional information.
7	Document all modifications and the results of the commissioning procedure.



---

# Chapter 7

## Diagnostics

---

### **WARNING**

#### **INEFFECTIVE SAFETY-RELATED FUNCTION AND/OR UNINTENDED EQUIPMENT OPERATION**

Only attempt to resolve alerts and errors detected by the device if you are fully familiar with the safety-related applications and the non-safety-related applications as well as the hardware used to operate your machine/process.

**Failure to follow these instructions can result in death, serious injury, or equipment damage.**

#### What Is in This Chapter?

This chapter contains the following topics:

Topic	Page
Diagnostics via LEDs	60
Diagnostics via Status Output Z1	62

## Diagnostics via LEDs

### Overview

The device features various LEDs (*see page 13*) that provide status information and information on alerts and detected errors.

Recommission the device (*see page 57*) if, during troubleshooting, you modify the position of the application function selector or the start function selector.

### LED POWER

State	Meaning
Off	No power supply
Solid on	Power supply on

### LED STATE

This LED provides information on the state of the safety-related outputs.

State	Meaning
Off	Safety-related outputs deactivated
Solid on	Safety-related outputs activated

### LED START

This LED provides information on the start condition. Refer to the chapter Start Function (*see page 51*) for detailed information on the conditions and timing of the selected start function.

State	Meaning
Off	Start condition not fulfilled
Solid on	Start condition fulfilled
Flashing	Waiting for start condition to be fulfilled

### LEDs S••

These LEDs provide information on the state of the corresponding safety-related input terminal.

State	Meaning
Off	Safety-related input deactivated
Solid on	Safety-related input activated

### LED ERROR - Alerts

This LED flashes in conjunction with additional S•• LEDs to indicate alerts. In the case of an alert, the device transitions to the defined safe state. Remove the cause of the alert to exit the defined safe state and resume operation. Contact your Schneider Electric service representative if the condition persists.

State	In conjunction with additional LEDs		Meaning	Remedy
	Additional LEDs	State of additional LEDs		
Flashing	S•• and S••	Flashing alternatively	Synchronization time exceeded.	<ul style="list-style-type: none"> <li>Verify correct operation of the sensors/devices providing the input signal.</li> <li>If synchronization is not required for your application, use an equivalent application function without synchronization.</li> </ul>

State	In conjunction with additional LEDs		Meaning	Remedy
	Additional LEDs	State of additional LEDs		
Flashing	S•• and S••	Flashing synchronously	Signal interlock condition of two safety-related inputs. The two safety-related inputs affected by the signal interlock condition must be deactivated for at least 1 second before the safety-related outputs can be activated again.	<ul style="list-style-type: none"> <li>Deactivate the two safety-related inputs affected by the signal interlock condition for at least 1 second.</li> <li>Verify correct operation of the contacts of the sensor/sdevices providing the input signal.</li> </ul>

### LED ERROR - Detected Errors

This LED lights solid in conjunction with additional LEDs to indicate detected errors. In the case of a detected error, the device transitions to the defined safe state. You must remove the cause of the detected error and perform a power cycle of the device to exit the defined safe state and resume operation. Contact your Schneider Electric service representative if the condition persists.

State	In conjunction with additional LEDs		Meaning	Remedy
	Additional LEDs	State of additional LEDs		
Solid on	STATE, START and S••	Flashing synchronously	General error detected.	<ul style="list-style-type: none"> <li>Verify correct wiring.</li> </ul>
Solid on	STATE, START and S••	Solid on	Configuration error detected.	<ul style="list-style-type: none"> <li>Verify that the positions of the selectors are appropriate for the application to be implemented.</li> </ul>
Solid on	POWER	Flashing	Power supply error detected.	<ul style="list-style-type: none"> <li>Verify correct wiring.</li> <li>Use a suitable power supply.</li> </ul>
Solid on	STATE	Flashing	Error detected at safety-related output.	<ul style="list-style-type: none"> <li>Perform a power cycle.</li> </ul>
Solid on	START	Flashing	Cross circuit detected at start input.	<ul style="list-style-type: none"> <li>Verify correct wiring.</li> </ul>
Solid on	STATE and START	Flashing synchronously	Error detected at safety-related output of extension module.	<ul style="list-style-type: none"> <li>Perform a power cycle.</li> </ul>
Solid on	S••	Flashing	Cross circuit detected at safety-related input (for example, incorrect wiring or application function with dynamization selected, but dynamization not supported by connected sensor/device).	<ul style="list-style-type: none"> <li>Verify correct wiring.</li> <li>Verify correct configuration.</li> </ul>
Solid on	S•• and S••	Flashing synchronously	Cross circuit detected at safety-related inputs (for example, incorrect wiring or application function with dynamization selected, but dynamization not supported by connected sensor/device).	<ul style="list-style-type: none"> <li>Verify correct wiring.</li> <li>Verify correct configuration.</li> </ul>

## Diagnostics via Status Output Z1

### Overview

**⚠ WARNING**

**INCORRECT USE OF OUTPUT**

Do not use the additional output Z1 for safety-related purposes.

**Failure to follow these instructions can result in death, serious injury, or equipment damage.**

The pulsed output Z1 provides diagnostics information in the form of a bit pattern. If the output Z1 is connected to a logic controller, the PreventaSupport library can be used to evaluate the diagnostics information. The library consists of the function blocks `FB_PreventaDiag` and `FB_PreventaMain`. The function block `FB_PreventaDiag` converts the bit sequences into diagnostics codes for monitoring the status of the device. The function block `FB_PreventaMain` uses the diagnostics codes as input to perform calculations concerning, for example, maintenance tasks.

Refer to the PreventaSupport Library Guide (*see page 7*) for details.

### Diagnostics Codes

The device encodes diagnostics information into sequences of 10 bits with a total duration of 2 s (each bit 200 ms). The first four bits (0010) represent the beginning of a bit sequence. The next six bits contain the diagnostics code itself.

The following table lists the bit sequences of the diagnostics codes, the description of the corresponding status as well as correctives, if applicable.

Bit sequence	Description	Correctives	Type <sup>(1)</sup>
0010101101	Supply voltage out of tolerance.	Verify correct wiring. Use a suitable power supply.	E
0010000011	General error detected.	Verify correct wiring. Perform a power cycle. If the error persists, replace the device.	E
0010000110	General error detected in expansion module.	Verify correct wiring. Perform a power cycle of the base safety module and the connected extension module. If the error persists, replace the extension module.	E
0010000111	Configuration error detected. The position of at least one of the selectors has been modified during operation.	Verify that the position of the selectors is appropriate for the application to be implemented. Perform a power cycle. If the error persists, replace the device.	E
0010001100	Cross circuit detected at input terminal S12.	Verify correct wiring. Verify that the sensor/device providing the input signal is suitable for cross circuit detection by means of dynamization. If it is not, use an application function without dynamization or a sensor/device suitable for dynamization. Verify correct operation of sensor/device providing the input signal. Perform a power cycle.	E
0010001111	Cross circuit detected at input terminal S22.	Verify correct wiring. Verify that the sensor/device providing the input signal is suitable for cross circuit detection by means of dynamization. If it is not, use an application function without dynamization or a sensor/device suitable for dynamization. Verify correct operation of sensor/device providing the input signal. Perform a power cycle.	E

**(1)** Type of message: E = Error detected, A = Alert, S = Status information

Bit sequence	Description	Correctives	Type <sup>(1)</sup>
0010110000	Cross circuit detected at start input.	Verify correct wiring. Verify that the device providing the input signal is suitable for cross circuit detection by means of dynamization. If it is not, use a start function without dynamization or a device suitable for dynamization. Verify correct operation of device providing the input signal. Perform a power cycle.	E
0010110011	Synchronization alert. One of the synchronized safety-related inputs is still deactivated, but the synchronization time has already elapsed.	Restore the original condition of the states of the inputs and retry. Verify correct operation of sensors/devices providing the input signals.	A
0010100111	Synchronization alert. Both synchronized safety-related inputs have been activated, but not within the synchronization time.	Restore the original condition of the states of the inputs and retry. Verify correct operation of sensors/devices providing the input signals.	A
0010110111	Safety-related inputs deactivated, safety-related outputs deactivated.	-	S
0010110101	Input S12 is expected to change its state. In the case of a configuration with antivalent inputs, inputs S12 and S13 are expected to change their states.	-	S
0010111100	Input S22 is expected to change its state. In the case of a configuration with antivalent inputs, inputs S22 and S23 are expected to change their states.	-	S
0010101011	Waiting for startup test.	-	S
0010101010	Waiting for rising edge for automatic/manual start or monitored start.	-	S
0010101110	Start input activated. Waiting for falling edge for monitored start.	-	S
0010101111	Device in operating state Run:Outputs Energized, safety-related outputs activated.	-	S
<b>(1)</b> Type of message: E = Error detected, A = Alert, S = Status information			





---

# Chapter 8

## Accessories, Service, Maintenance, and Disposal

---

### What Is in This Chapter?

This chapter contains the following topics:

Topic	Page
Accessories	66
Maintenance	67
Transportation, Storage, and Disposal	68
Service Addresses	69

## Accessories

### Accessories

The following accessories are available for the device:

Description	Commercial Reference
Coding bits The coding bits are used if the terminal blocks are removed to help ensure correct insertion of the terminal blocks into the device. 30 pieces per packaging unit	XPSEC
Sealing strips The uniquely numbered sealing strips are used to seal the transparent front cover of the device to help prevent unauthorized access to the configuration selectors. 10 pieces per packaging unit	XPSES

## Maintenance

### Service and Repairs

The device contains no user-serviceable parts. Do not attempt to open, service, or repair the device.

### Maintenance Plan

Maintenance plan:

- Ensure that a safety-related function implemented with the device is triggered at the minimum intervals required by the regulations, standards, and process definitions applicable to your machine/process.
- Inspect the wiring at regular intervals.
- Tighten the threaded connections at regular intervals.
- Verify that the device is not used beyond the specified lifetime (*see page 24*).

To determine the end of the lifetime, add the specified lifetime to the date of manufacture indicated on the nameplate (*see page 14*) of the device.

Example: If the date of manufacture indicated on the nameplate is 2019-W10, do not use the device after week 10, 2039.

As a machine designer or system integrator, you must include this information in the maintenance plan for your customer.

## Transportation, Storage, and Disposal

### Transportation and Storage

Ensure that the environmental conditions (*see page 18*) specified for transportation and storage are respected.

### Disposal

Dispose of the product in accordance with all applicable regulations.

Visit <https://www.se.com/green-premium> for information and documents on environmental protection as per ISO 14025 such as:

- EoLi (Product End-of-Life Instructions)
- PEP (Product Environmental Profile)

## Service Addresses

### Schneider Electric Automation GmbH

Schneiderplatz 1  
97828 Marktheidenfeld, Germany  
Phone: +49 (0) 9391 / 606 - 0  
Fax: +49 (0) 9391 / 606 - 4000  
Email: info-marktheidenfeld@se.com

### Additional Contact Addresses

See the homepage for additional contact addresses:

<https://www.se.com>





## A

accessories, *66*  
activation, safety-related inputs, *32*  
alerts, *60*  
antivalent behavior, safety-related inputs, *32*  
application functions  
  configuration, *56*  
application functions: see index entry functions, *44*  
automatic start, *51*

## B

block diagram, *40*

## C

Category, *24*  
commissioning, *57*  
configuration  
  application functions, *56*  
  start functions, *53*  
cross circuit detection, *35*

## D

DCavg, *24*  
deactivation, safety-related inputs, *32*  
degree of protection, *20*  
diagnostics, *60*  
diagram, block, *40*  
dimensions, *20*  
dynamization, *35*

## E

electrical characteristics, *21*  
electrical durability, *24*  
electro-sensitive protective equipment (type 4 light curtains) as per IEC 61496-1, monitoring of, *50*  
electromagnetic compatibility, *28*  
EMC, *28*  
Emergency Stop circuits as per ISO 13850 and IEC 60204-1, stop category 0, monitoring of, *45, 46*  
environmental characteristics, *18*  
errors, detected, *60*  
example Emergency Stop  
  overview, *30*  
  timing diagram, *30*

## F

functional safety data, *24*  
functions  
  automatic start, *51*  
  configuration of application functions, *56*  
  configuration of start function, *53*  
  dynamization, *35*  
  light curtains, type 4 as per IEC 61496-1, monitor-

ing of, *50*  
  manual start, *51*  
  monitored start with falling edge, *52, 52*  
  monitoring of electro-sensitive protective equipment (type 4 light curtains) as per IEC 61496-1, *50*  
  monitoring of Emergency Stop circuits as per ISO 13850 and IEC 60204-1, stop category 0, *45, 46*  
  monitoring of guards as per ISO 14119/14120 with coded magnetic switches, *47*  
  monitoring of guards as per ISO 14119/14120 with electrical switches, *45, 46, 47*  
  monitoring of proximity switches, *47, 48, 49*  
  monitoring of RFID sensors, *50*  
  overview application functions, *44*  
  signal interlock monitoring, *36*  
  start functions, *51*  
  synchronization of safety-related inputs, *34*

## G

guards as per ISO 14119/14120 with coded magnetic switches, monitoring of, *47*  
guards as per ISO 14119/14120 with electrical switches, monitoring of, *45, 46, 47*

## H

HFT, *24*

## I

input, start  
  technical data, *21*  
  wiring, *42*  
inputs, safety-related  
  technical data, *21*  
  wiring, *41*  
installation, *38, 39, 40*  
  control cabinet, *38*  
  enclosure, *38*  
  mechanical, *39*  
  prerequisites, *38*

## L

L, *24*  
LEDs, *60*  
lifetime, *24*  
light curtains type 4 as per IEC 61496-1, monitoring of, *50*

## M

maintenance, *67*  
manual start, *51*  
mechanical characteristics, *20*  
monitored start with falling edge, *52*  
monitoring of electro-sensitive protective equipment (type 4 light curtains) as per IEC 61496-1, *50*

monitoring of Emergency Stop circuits as per ISO 13850 and IEC 60204-1, stop category 0, *45, 46*  
 monitoring of guards as per ISO 14119/14120 with coded magnetic switches, *47*  
 monitoring of guards as per ISO 14119/14120 with electrical switches, *45, 46, 47*  
 monitoring of proximity switches, *47, 48, 49*  
 monitoring of RFID sensors, *50*  
 mounting, *39*  
   DIN rail, *39*  
   screw mounting, *39*  
 MTTFd, *24*

## N

nameplate, *14*

## O

operating cycles over lifetime, *24*  
 operating state transitions, *29*  
 operating states, *29*  
 operation, environmental characteristics, *18*  
 output Z1  
   diagnostics, *62*  
   technical data, *22*  
   wiring, *42*  
 outputs, safety-related  
   technical data, *22*  
   wiring, *41*

## P

Performance Level, *24*  
 PFHD, *24*  
 power supply  
   technical data, *21*  
   wiring, *42*  
 proximity switches, monitoring of, *47, 48, 49*

## R

response times  
   technical data, *23*  
 RFID sensors, monitoring of, *50*

## S

safe state, defined, *24*  
 Safety Integrity Level, *24*  
 safety-related inputs  
   activation, *32*  
   antivalent behavior, *32*  
   deactivation, *32*  
   dynamization, *35*  
   signal interlock monitoring, *36*  
   synchronization, *34*  
   technical data, *21*  
   wiring, *41*  
 safety-related outputs  
   technical data, *22*  
   wiring, *41*  
 service addresses, *69*  
 SFF, *24*  
 signal interlock monitoring, *36*

SIL, *24*  
 SILCL, *24*  
 start functions, *51*  
   automatic start, *51*  
   configuration, *53*  
   dynamization, *35*  
   manual start, *51*  
   monitored start with falling edge, *52, 52*  
 start input  
   technical data, *21*  
   wiring, *42*  
 startup test, *52*  
 state machine, *29*  
 state transitions, *29*  
 status output Z1  
   diagnostics, *62*  
   technical data, *22*  
   wiring, *42*  
 stop category, *24*  
 storage, environmental characteristics, *18*  
 stripping lengths, *20*  
 supply  
   technical data, *21*  
   wiring, *42*  
 synchronization, *34*

## T

technical data  
   degree of protection, *20*  
   dimensions, *20*  
   electrical characteristics, *21*  
   environmental characteristics, *18*  
   functional safety data, *24*  
   mechanical characteristics, *20*  
   operation, *18*  
   power supply, *21*  
   response times, *23*  
   safety-related inputs, *21*  
   safety-related outputs, *22*  
   start input, *21*  
   status output Z1, *22*  
   storage, *18*  
   stripping lengths, *20*  
   supply, *21*  
   tightening torques terminals, *20*  
   timing data, *23*  
   transportation, *18*  
   weight, *20*  
   wire cross sections, *20*  
 tightening torques terminals, *20*  
 timing data, *23*  
 transportation, environmental characteristics, *18*  
 troubleshooting, *60*  
 type code, *15*

## V

view  
   front view, *13*  
   side view, *13*

## W

weight, *20*



---

wire cross sections, *20*  
wiring, *40*  
    output Z1, *42*  
    power supply, *42*  
    safety-related inputs, *41*  
    safety-related outputs, *41*  
    start input, *42*  
    supply, *42*  
    Z1, *42*

## Z

Z1 status output  
    diagnostics, *62*  
    technical data, *22*  
Z1, status output  
    wiring, *42*  
ZVEI CB24I, *21*