

Panasonic®

Programmable Controller

FP
SERIES **FP0 A/D**
Converter Unit
Technical Manual



BEFORE BEGINNING

This manual and everything described in it are copyrighted. You may not copy this manual, in whole or part, without written consent of Panasonic Electric Works Europe AG.

Panasonic Electric Works Europe AG pursues a policy of continuous improvement of the design and performance of its products, therefore, we reserve the right to change the manual/product without notice. In no event will Panasonic Electric Works Europe AG be liable for direct, special, incidental, or consequential damage resulting from any defect in the product or its documentation, even if advised of the possibility of such damages.

We invite your comments on this manual. Please e-mail us at:
tech-doc@eu.pewg.panasonic.com

Please direct support matters and technical questions to your local Panasonic representative.

LIMITED WARRANTY

If physical defects caused by distribution are found, Panasonic Electric Works Europe AG, will replace/repair the product free of charge. Exceptions include:

- **When physical defects are due to different usage/treatment of the product other than described in the manual.**
- **When physical defects are due to defective equipment other than the distributed product.**
- **When physical defects are due to modifications/repairs by someone other than Panasonic Electric Works Europe AG.**
- **When physical defects are due to natural disasters.**

MS-DOS and Windows are registered trademarks of Microsoft Corporation.
IBM Personal Computer AT is a registered trademark of the International Business Machines Corporation.

Table of Contents

Chapter 1 Parts and Terminology

1.1	Parts and Functions	2
1.2	Analog Input Terminal Block	3
1.3	Expansion Limit	4

Chapter 2 Wiring and Input Range Setting Switch

2.1	Wiring	6
2.2	Input Range Setting (DIP) Switches	7

Chapter 3 A/D Conversion Characteristics

3.1	Current Range	10
3.2	Voltage Range	11
3.3	Averaging Function for Voltage and Current Ranges	14

Chapter 4 I/O Allocation and Program

4.1	I/O Number of A/D Converter Unit	16
4.2	Programming with Control FPWIN-GR	18
4.3	Programming with Control FPWIN Pro	19

Chapter 5 Specifications and Dimensions

5.1	Specifications	22
5.2	Dimensions	25

Index

Record of Changes

Chapter 1



Parts and Terminology

1.1 Parts and Functions

FP0–A80 A/D converter unit

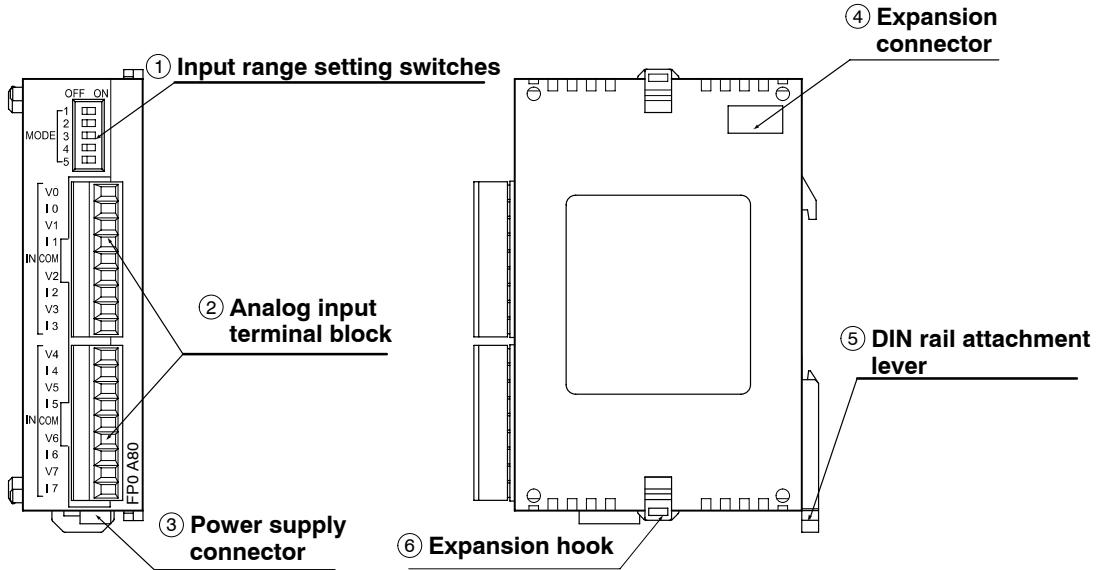

① Input range setting (DIP) switches (voltage/current)

This switch is used to change the input mode (between voltage and current). All eight input channels of the A/D converter unit operate at the same level. [See page 7](#) for details.

② Analog input terminal block (9-pin)

Use a terminal block socket made by Phoenix Contact Co. (product number: 1840434). (See FP0 Hardware Manual.)

③ Power supply connector

The power supply connector (supply 24V DC) is hooked up by using the power supply cable (AFP0581) that comes with the unit.

④ Expansion connector

The expansion connector hooks up the expansion unit to the internal circuit of this unit. (See FP0 Hardware Manual.)

⑤ DIN rail attachment lever

The DIN rail attachment lever allows simple attachment to a DIN rail. The lever is also used for installation on a FP0 slim type mounting plate (AFP0803).

⑥ Expansion hook

The expansion hook is used to secure expansion units.

1.2 Analog Input Terminal Block

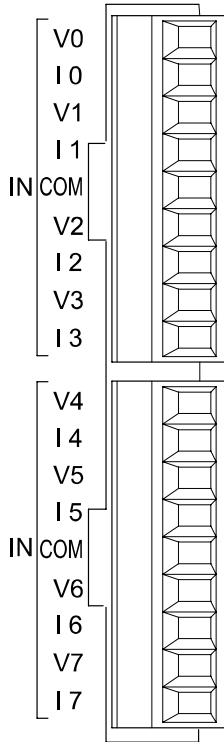

Pin number	Name	Description
1	V0	Analog input channel 0, voltage input
2	I0	Analog input channel 0, current input
3	V1	Analog input channel 1, voltage input
4	I1	Analog input channel 1, current input
5	COM	Analog input, input common
6	V2	Analog input channel 2, voltage input
7	I2	Analog input channel 2, current input
8	V3	Analog input channel 3, voltage input
9	I3	Analog input channel 3, current input

1	V4	Analog input channel 4, voltage input
2	I4	Analog input channel 4, current input
3	V5	Analog input channel 5, voltage input
4	I5	Analog input channel 5, current input
5	COM	Analog input, input common
6	V6	Analog input channel 6, voltage input
7	I6	Analog input channel 6, current input
8	V7	Analog input channel 7, voltage input
9	I7	Analog input channel 7, current input



Notes

- When the analog input is a current signal, bridge the V and I input pins externally.
- The two COM terminals are connected internally.

1.3 Expansion Limit

The unit can be connection to a combined maximum of three other expansion units and intelligent units.

Chapter 2

Wiring and Input Range Setting Switch

2.1 Wiring

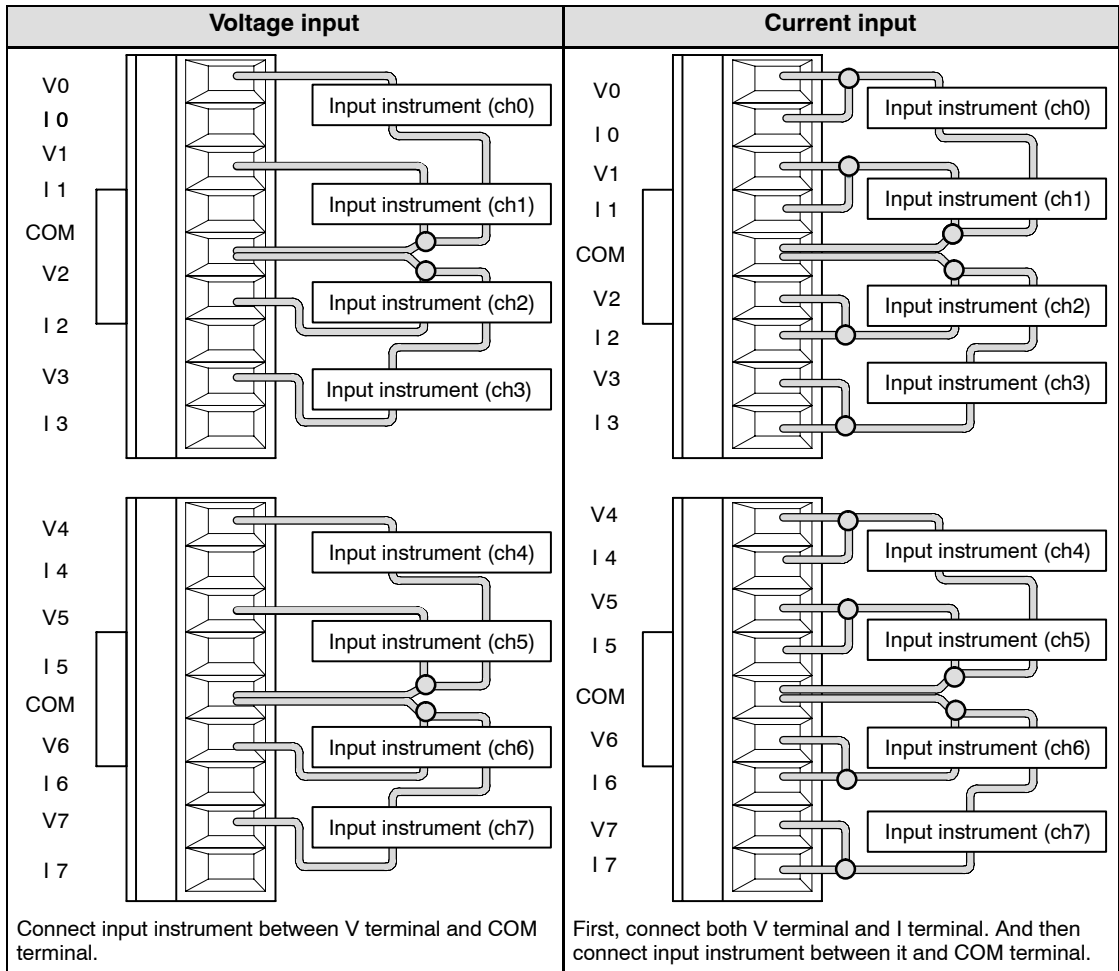

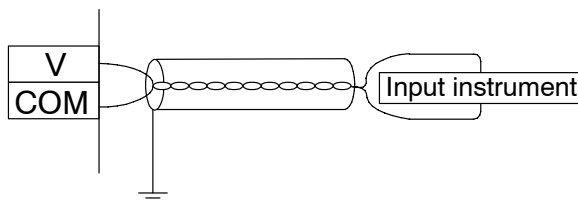

Notes

- Tie the COM connectors for two channels together as indicated by the gray circles (○) in the diagram above so that no more than two wires go to each COM terminal.
- The two COM terminals are connected internally.
- We recommend that you use dual-core twisted pair shielded wiring for the analog input wiring, and that you connect the shield to earth.

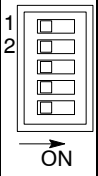
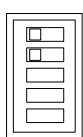
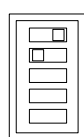
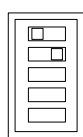
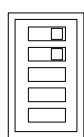
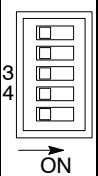
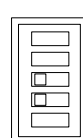
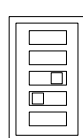
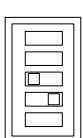
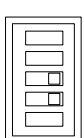
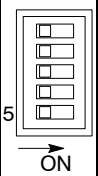

2.2 Input Range Setting (DIP) Switches

Mode	Switch number	Range							
Analog input range	1 and 2	0 to 5V 0 to 20mA (see note 1)		-10 to 10V		-100 to 100mV			
	 ON				or				
Number of input channels	3 and 4	Conversion channel	Number of input channels	Conversion channel	Number of input channels	Conversion channel	Number of input channels	Conversion channel	Number of input channels
		ch0 and 1	2	ch0 to 3	4	ch0 to 5	6	ch0 to 7	8
	 ON								
Averaging function	5	No averaging (see note 2)		With averaging (see note 3)					
									



Notes

- 1) It is possible to use the 0 to 5V range and 0 to 20mA range together.
- 2) The A/D conversion data is set for the specified input contact point area for each A/D conversion on each channel.
- 3) On each channel, for each A/D conversion, the maximum and minimum values from the data of the last ten times are excluded, and the data from the other eight times is averaged, and the result set.
(Use when the environment contains a lot of noise.)
- 4) The switch reads only once when the power supply of FP0 control unit is turned on.

Chapter 3



A/D Conversion Characteristics

3.1 Current Range

Current range: 0 to 20mA DC input

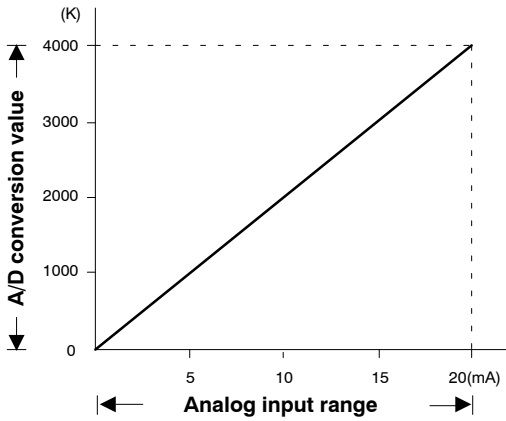

Corresponding table of A/D conversion values

Input current (mA)	A/D conversion value
0.0	0
2.5	500
5.0	1000
7.5	1500
10.0	2000
12.5	2500
15.0	3000
17.5	3500
20.0	4000

Processing if the range is exceeded

Input value	Converted value
0mA or less (including negative value)	0
20mA or more	4000

3.2 Voltage Range

Voltage range: 0 to 5V DC input

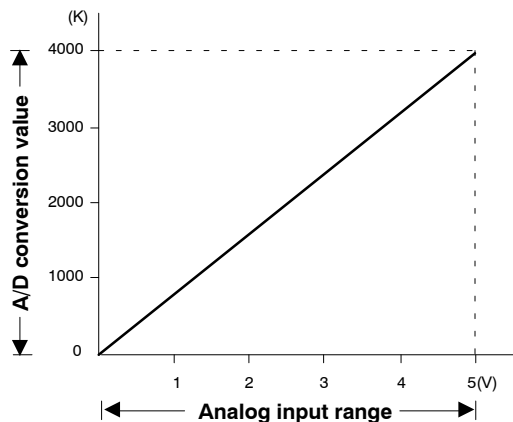

Corresponding table of A/D conversion values

Input voltage (V)	A/D conversion value
0.0	0
0.5	400
1.0	800
1.5	1200
2.0	1600
2.5	2000
3.0	2400
3.5	2800
4.0	3200
4.5	3600
5.0	4000

Processing if the range is exceeded

Input value	Converted value
0V or less (including negative value)	0
5V or more	4000

Voltage range: -10 to +10V DC input

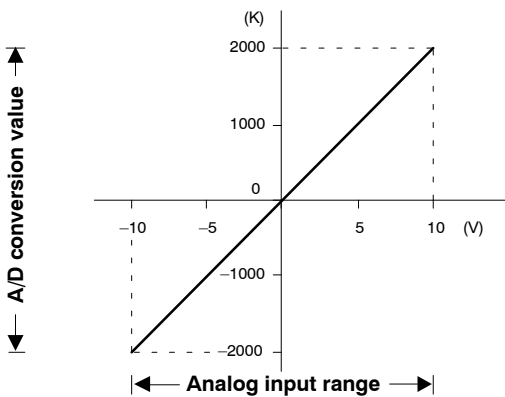

Corresponding table of A/D conversion values

Input voltage (V)	A/D conversion value
-10.0	-2000
-7.5	-1500
-5.0	-1000
-2.5	-500
0.0	0
+2.5	+500
+5.0	+1000
+7.5	+1500
+10.0	+2000

Processing if the range is exceeded

Input value	Converted value
-10V or less	-2000
+10V or more	+2000

Voltage range: -100 to +100mV DC input

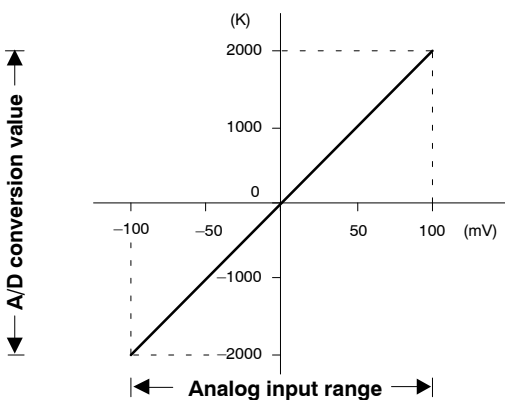

Corresponding table of A/D conversion values

Input voltage (mV)	A/D conversion value
-100.0	-2000
-75.0	-1500
-50.0	-1000
-25.0	-500
0.0	0
+25.0	+500
+50.0	+1000
+75.0	+1500
+100.0	+2000

Processing if the range is exceeded

Input value	Converted value
-100mV or less	-2000
+100mV or more	+2000

3.3 Averaging Function for Voltage and Current Ranges

When the averaging function is set to on, the internal processing of the A/D conversion unit is as shown in the diagram below (in this example there are two input channels, and the input range setting switch Nos. 3 and 4 are off).

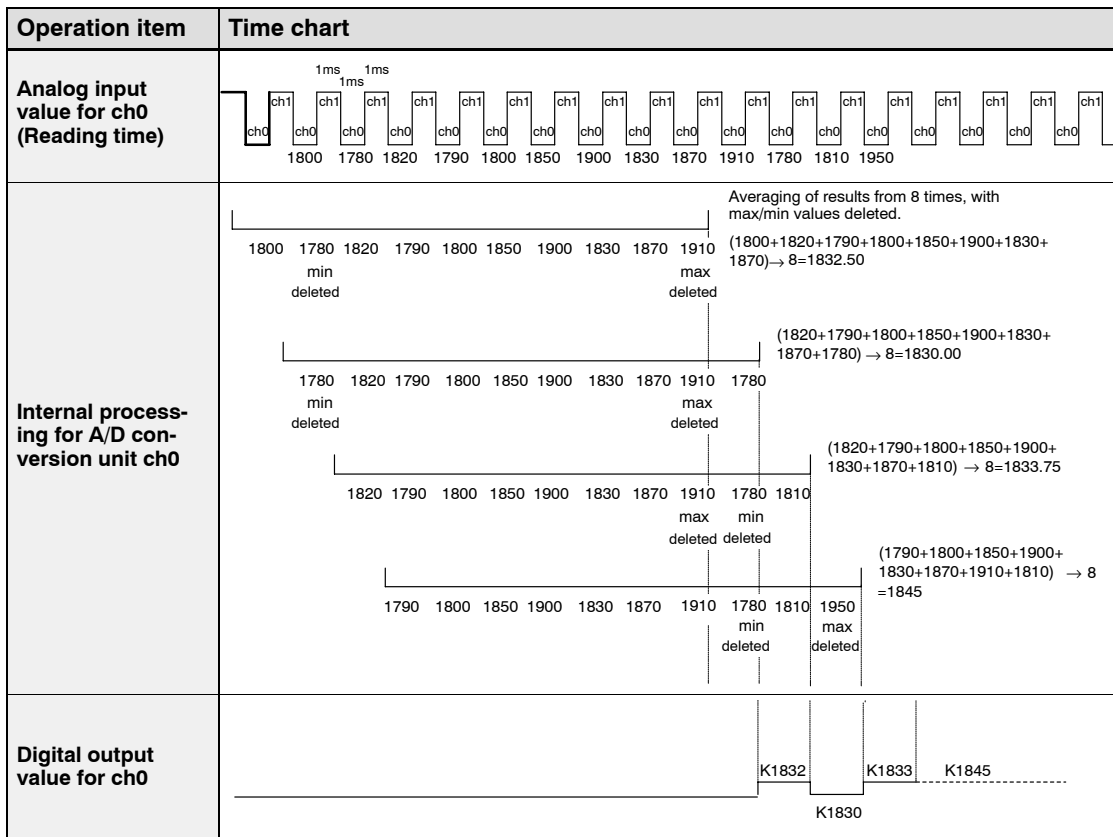

Starting with the most recent data, the data from the last ten times is taken. The maximum and minimum values are deleted, and the averaging is carried out on the remaining eight items. The obtained values are output to WX2 and WX3. The values output at this time always use the most recent averaged value (decimals are discarded).

Chapter 4

I/O Allocation and Program

4.1 I/O Number of A/D Converter Unit

I/O number of A/D converter unit

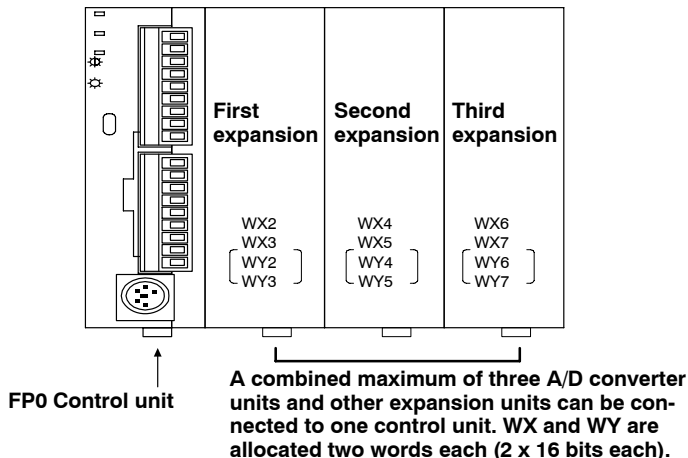

With the setup illustrated in the diagram above, the data for each channel is allocated as I/O data as indicated in the table below.

A/D converter unit input channel	First expansion	Second expansion	Third expansion
ch0, 2, 4, 6 (Each 16 points)	WX2 (X20 to X2F)	WX4 (X40 to X4F)	WX6 (X60 to X6F)
ch1, 3, 5, 7 (Each 16 points)	WX3 (X30 to X3F)	WX5 (X50 to X5F)	WX7 (X70 to X7F)

Example of I/O allocation

The diagram below shows you the allocation of each channel's conversion data, WX2 and WX3 when this unit is connected to the first expansion.

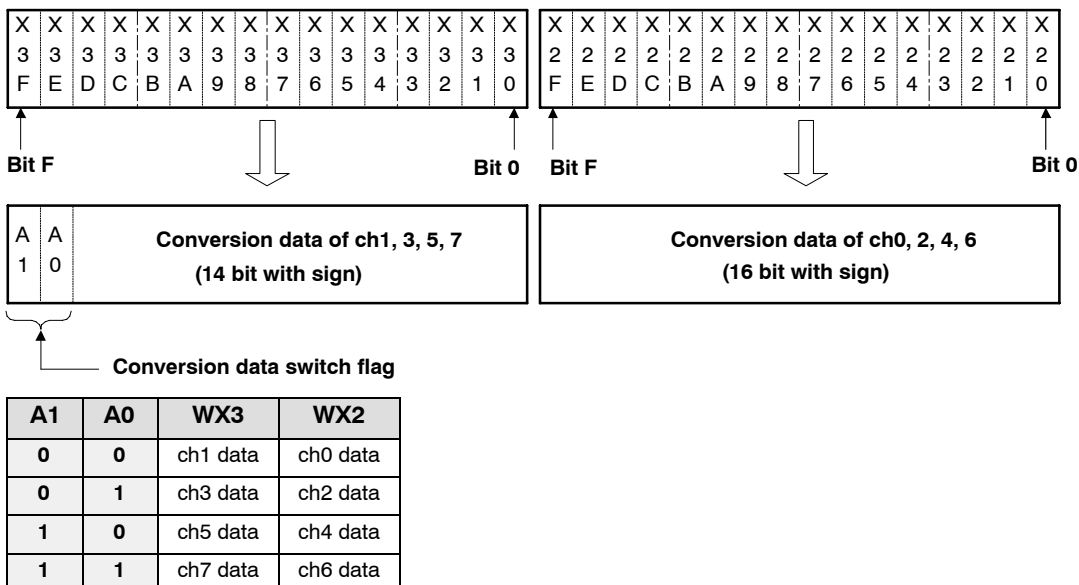

Conversion data switch flags

The resolution of the A/D converter unit is 12 bits, but when data is transferred to the control unit, it is converted to 16-bit data. Therefore, although the WX2 data requires no processing, for the WX3 data, the top two bits are used as conversion data switching flags. Accordingly, the top two bits are processed as follows.

When the A/D conversion data is negative “-”, the WX2 and WX3 data become two’s complement.

In other words, bit C to bit F of WX2 and bit C to bit D of WX3 become “1”.

Also, because the top two bits of WX3 are used as conversion data switch flags, masking is required so that the bits are “00” when the conversion data is positive “+”, and “11” when the conversion data is negative “-”.

Ch3 data	WX3	→	Data after masking
1	0100000000000001	→	0000000000000001
-1	0111111111111111	→	1111111111111111

Conversion data switch flags Mask applied to the above values

4.2 Programming with Control FPWIN-GR

Ladder program example for loading data from each channel

Indicates the program that stores in data registers DT0 to DT7 the from ch0 to ch7 A/D conversion data that is assigned to the first expansion.

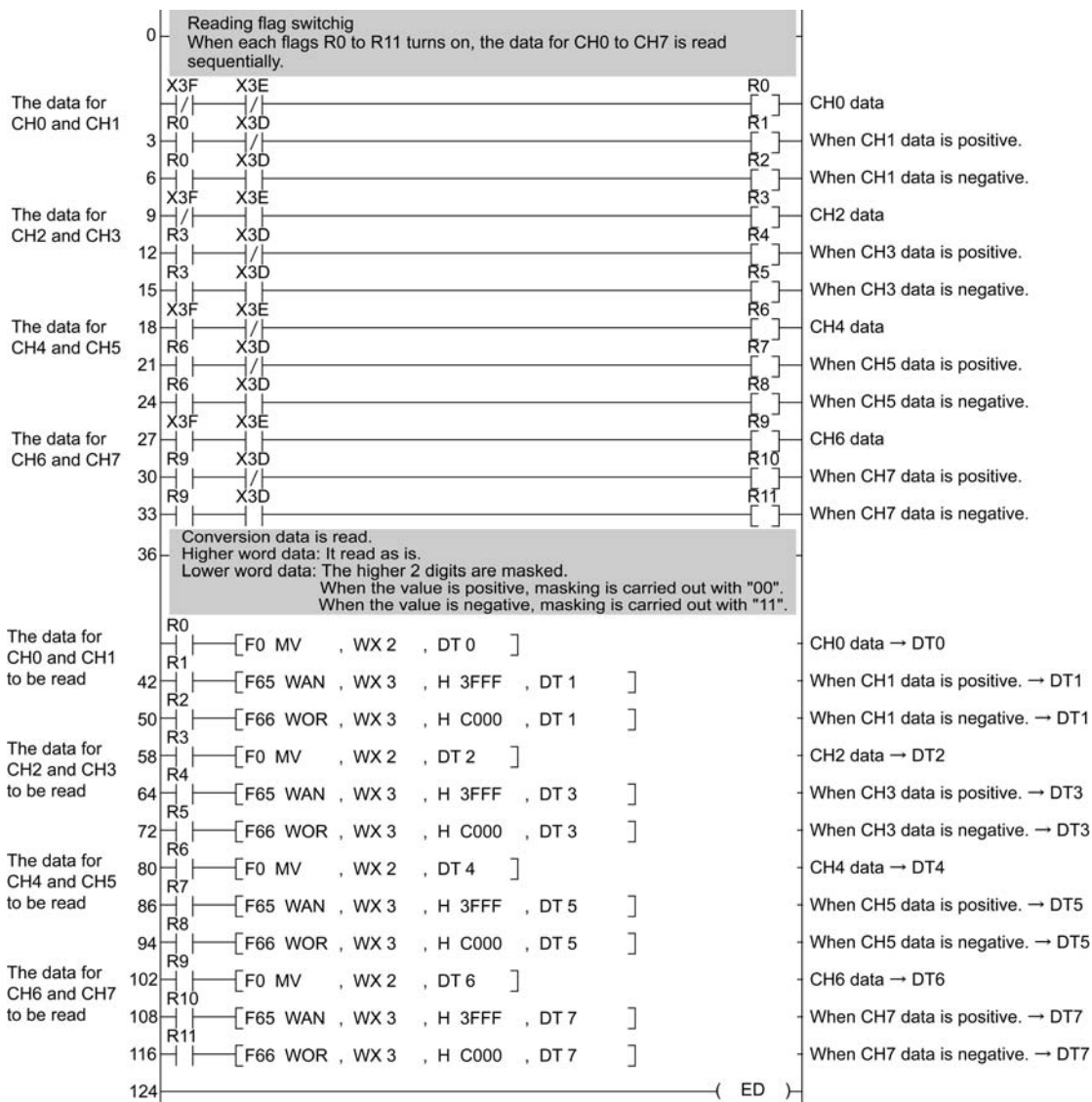

Note

If the expansion positions have changed, see page 16 and change X3D, X3E, X3F, WX2 and WX3.

4.3 Programming with Control FPWIN Pro

Control FPWIN Pro provides the convenient function block Read_AD8 to facilitate programming with the FP0 A/D converter unit.

You may download it free of charge from Panasonic Electric Work Europe AG's website at: www.panasonic-electric-works.com.

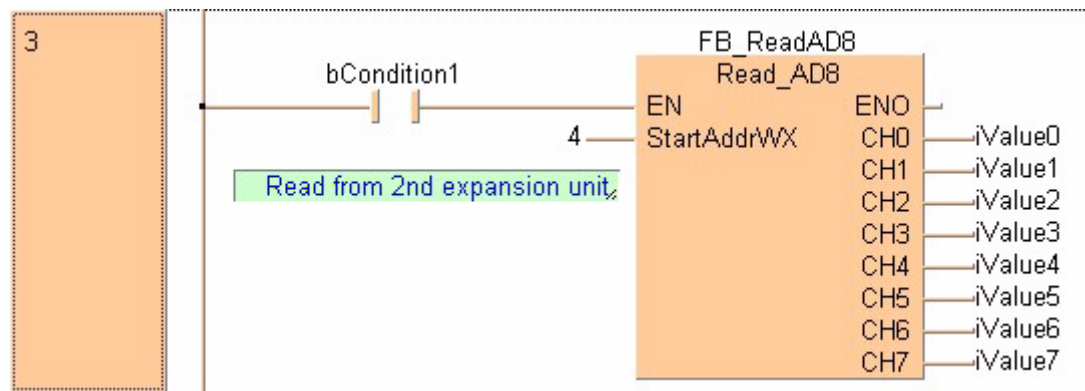

Chapter 5



Specifications and Dimensions

5.1 Specifications

General specifications

Item	Description
Rated operation voltage	24V DC
Operating voltage range	21.6 to 26.4V DC
Rated current consumption	60mA or less (at 24V DC)
Current consumption increase of control unit	20mA or less (at 24V DC) (see note)
Allowable instantaneous stop time	10ms
Ambient temperature	0 to +55°C/32 to +131°F
Storage temperature	-20 to +70°C/-4 to +158°F
Ambient humidity	30 to 85%RH (non-condensing)
Storage humidity	30 to 85%RH (non-condensing)
Breakdown voltage	500V AC for 1 minute between analog input terminal and power supply/ground terminal
Insulation resistance	Min. 100MΩ (measured with a 500V DC megger) for between analog input terminal and power supply/ground terminal
Vibration resistance	10 to 55Hz, 1 cycle/min: double amplitude of 0.75mm/ 0.030in., 10 min on 3 axes
Shock resistance	Shock of 98m/s ² or more, 4 times on 3 axes
Noise immunity	1,000 Vp-p with pulse widths 50ns and 1μs (based on in-house measurements)
Operating condition	Free from corrosive gases and excessive dust
Weight	Approx. 90g/3.175oz



Note

For each additional A/D converter unit connected to a control unit, the current consumption increases by 20mA (max.).

Analog input specifications

Item	Description	
Number of input points	8 channels/unit (the number of input points can be switched to 2, 4, 6 or 8 channels)	
Input range	Voltage range	0 to 5V, -10 to +10V, -100 to +100mV
	Current range	0 to 20mA
Digital output	0 to 5V 0 to 20mA	K0 to K4000 (H0000 to H0FA0, see note 1)
	-10 to +10V -100 to 100mV	K -2000 to K +2000 (HF830 to H07D0, see note 1)
Resolution	Voltage/Current range	1/4000 (12bits)
Conversion speed	Voltage/Current range	1ms/channel (see note 2)
Overall precision	Voltage/Current range	±1%F.S. or less (at 0 to 55°C/32 to 131°F), ±0.6% F.S. or less (at 25°C/77°F)
Input impedance	Voltage range	1 MΩ or more
	Current range	250Ω

Item		Description
Absolute maximum input	Voltage range	±15V
	Current range	+30mA
Insulation method (see note 3)		Between analog input terminal to FP0 internal circuit: photocoupler insulation (non-insulated between analog inputs) Between analog input terminal to A/D converter unit external power supply: insulation-type DC/DC converter
Number of FP0 input contact points		32 input contact points First half (16 points): analog input ch0, 2, 4 and 6 data (WX2) (see note 4) Second half (16 points): analog input ch1, 3, 5 and 7 data (WX3) (see note 4) 32 output contact points (Not used)
Averaging function		Can be switched on and off



Notes

- 1) If the analog input value exceeds the upper/lower limit, the digital value is held at the upper/lower limit.
- 2) The time noted below is required before the analog data is reflected in the control unit input.

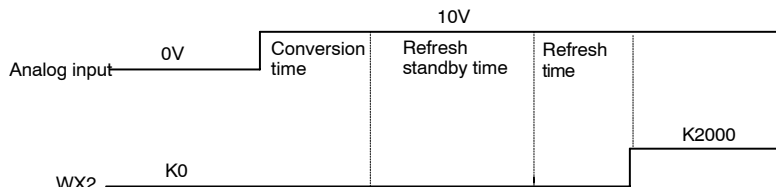

Conversion time: 1 ms to 1 ms x number of input channels

Refresh standby time: 0ms to scan time x $\left(\frac{\text{number of input channels}}{2} \right)$

Refresh time: 1 ms x number of expansion units

Set switch for the number of input channels.

The control unit loads two channels worth of data at each control unit scan. In other words, if the switch for the number of input channels is set to eight channels, the control unit data is updated once every four scans.

- 3) Refer to the schematic diagram of insulation methods below.

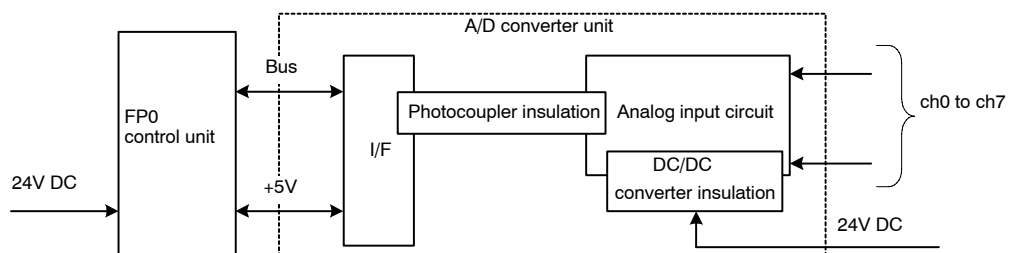

- 4) The contact numbers change depending on the expansion position. (These values represent when the unit is installed in the closest position to the control unit.) For details, [see page 16](#).**

5.2 Dimensions

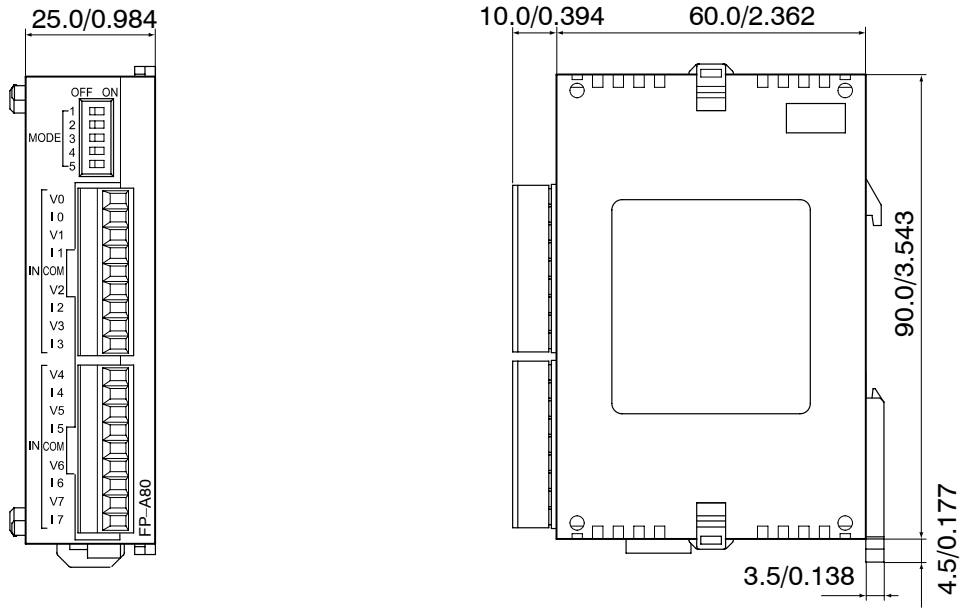

(unit: mm/in.)

Index

A

A/D Conversion Characteristics, 10
 Averaging Function, 14
 Current Range, 10
 Voltage Range, 11
Analog Input Terminal Block, 2, 3

D

Dimensions, 25
DIN Rail Attachment Lever , 2
DIP Switches. *See* Input Range Setting Switches

E

Expansion Connector, 2
Expansion Hook, 2

F

FPWIN Pro, 19
FPWIN-GR, 18
Functions, 2

I

I/O Allocation, 16
 Conversion Data Switch Flags, 17
 I/O Number, 16
 Program FPWIN-GR, 18
Input Instrument, 6
Input Range Setting Switch
 Conversion Channel, 7
 Number of Input Channels, 7
Input Range Setting Switches, 2, 7

P

Parts, 2
Power Supply Connector, 2
Programming example, FPWIN Pro, 19

S

Specifications, 22
 Analog Input, 22
 General, 22

W

Wiring, 6

Record of Changes

Manual no.	Date	Description of changes
ARCT1F321END	June 2001	First European Edition
ARCT1F321V1.1END	Dec. 2006	Second European Edition Changeover to Panasonic. Inclusion of programming function block for Control FPWIN Pro (see page 19). Update of Control FPWIN-GR programming example (see page 18).

GLOBAL NETWORK



North America

Europe

Asia Pacific

China

Japan

Europe

- **Headquarters** **Panasonic Electric Works Europe AG**
Rudolf-Diesel-Ring 2, 83607 Holzkirchen, Germany, Tel. (08024) 648-0, Fax (08024) 648-111, www.panasonic-electric-works.com
- **Austria** **Panasonic Electric Works Austria GmbH**
Josef Madersperger Straße 2, A-2362 Biedermannsdorf, Austria, Tel. (02236) 26846, Fax (02236) 46133, www.panasonic-electric-works.at
- **Benelux** **Panasonic Electric Works Sales Western Europe B. V.**
De Rijn 4, (Postbus 211), 5684 PJ Best, (5680 AE Best), Netherlands, Tel. (0499) 37 27 27, Fax (0499) 37 21 85, www.panasonic-electric-works.nl
- **Czech Republic** **Panasonic Electric Works Czech s.r.o**
Prumyslová 1, 34815 Planá, Tel. (0374) 79 99 90, Fax (0374) 79 99 99, www.panasonic-electric-works.cz
- **France** **Panasonic Electric Works Sales Western Europe B. V. French Branch Office**
B.P. 44, F-91371 Verrières le Buisson CEDEX, France, Tél. 01 60 13 57 57, Fax 01 60 13 57 58, www.panasonic-electric-works.fr
- **Germany** **Panasonic Electric Works Deutschland GmbH**
Rudolf-Diesel-Ring 2, 83607 Holzkirchen, Germany, Tel. (08024) 648-0, Fax (08024) 648-555, www.panasonic-electric-works.de
- **Ireland** **Panasonic Electric Works UK Ltd. Irish Branch Office**
Dublin, Republic of Ireland, Tel. (01) 4600969, Fax (01) 4601131, www.panasonic-electric-works.ie
- **Italy** **Panasonic Electric Works Italia s.r.l.**
Via del Commercio 3-5 (Z.I. Ferlina), I-37012 Bussolengo (VR), Italy, Tel. (045) 675 27 11, Fax (045) 6 70 04 44, www.panasonic-electric-works.it
- **Nordic Countries** **Panasonic Electric Works Nordic AB**
Sjöängsvägen 10, 19272 Sollentuna, Sweden, Tel. (+46) 8 59 47 66 80, Fax (+46) 8 59 47 66 90, www.panasonic-electric-works.se
- **Portugal** **Panasonic Electric Works Portugal España S.A. Portuguese Branch Office**
Avda Adelino Amaro da Costa 728 R/C J, 2750-277 Cascais, Portugal, Tel. (351) 21 481 25 20, Fax (351) 21 481 25 29, www.panasonic-electric-works.es
- **Spain** **Panasonic Electric Works España S.A.**
Parque Empresarial Barajas, San Severo, 20, 28042 Madrid, Spain, Tel. (91) 329 38 75, Fax (91) 329 29 76, www.panasonic-electric-works.es
- **Switzerland** **Panasonic Electric Works Schweiz AG**
Grundstrasse 8, CH-6343 Rotkreuz, Switzerland, Tel. (041) 799 70 50, Fax (041) 799 70 55, www.panasonic-electric-works.ch
- **UK** **Panasonic Electric Works UK Ltd.**
Sunrise Parkway, Linford Wood East, Milton Keynes, MK14 6LF, England, Tel. (01908) 231 555, Fax (01908) 231 599, www.panasonic-electric-works.co.uk

North & South America

- **USA** **PEW Corporation of America Head Office USA**
629 Central Avenue, New Providence, N.J. 07974, USA, Tel. 1-908-464-3550, Fax 1-908-464-8513

Asia

- **China** **Panasonic Electric Works (China) Co., Ltd.**
2013, Beijing Fortune, Building 5, Dong San Huan Bei Lu, Chaoyang District, Beijing, China, Tel. 86-10-6590-8646, Fax 86-10-6590-8647
- **Hong Kong** **Panasonic Electric Works (Hong Kong) Co., Ltd.**
Rm1601, 16/F, Tower 2, The Gateway, 25 Canton Road, Tsimshatsui, Kowloon, Hong Kong, Tel. (852) 2956-3118, Fax (852) 2956-0398
- **Japan** **Matsushita Electric Works, Ltd.**
1048 Kadoma, Kadoma-shi, Osaka 571-8686, Japan, Tel. 06-6908-1050, Fax 06-6908-5781, www.mew.co.jp/e-acg/
- **Singapore** **Panasonic Electric Works Asia Pacific Pte. Ltd.**
101 Thomson Road, #25-03/05, United Square, Singapore 307591, Tel. (65) 6255-5473, Fax (65) 6253-5689