

Datasheet • Electronic TERMSERIES

Relays and Solid-State Relays

NEW

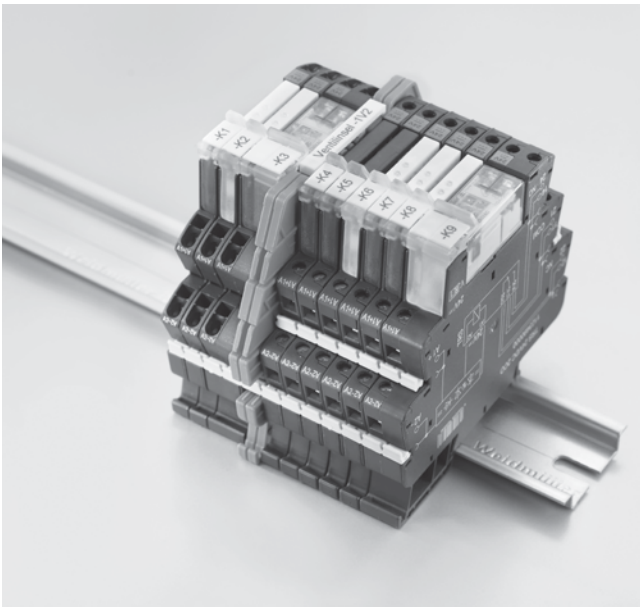

Weidmüller's TERMSERIES offers innovative pluggable electromechanical and solid-state relays equipped with one or two changeover contacts housed in a slim 6.4 mm or 12.8 mm design with matching profiles that can be combined as required in the customer's application and reliably switch loads of up to 8A at 250V.

Depending on the application customers can choose between products with a fixed voltage input or Weidmüller's unique multi-voltage input which allows conditioning signals from 24V up to 230V AC/DC with just one module.

A distinctive status display is available through integrated fiber-optic technology that completely illuminates the ejector. The ejector also ensures the safe removal of the switching element.

The versions with single and dual changeover contacts as well as screw clamp and tension clamp terminals have the same profile and can be jumpered with each other with easy to use cross connectors. Well thought out accessories such as isolation plates used to visibly group signals, electrically isolate two modules for up to 400V, or to add labels for enhanced marking options make this product family a well rounded offering.

- Slim design with 6.4 mm or 12.8 mm width
- 1 CO and 2 CO contact versions
- Screw clamp and tension clamp technology
- Input voltages from 5 up to 230V
- Unique multi-voltage input version for 24V-230V AC/DC
- Distinctive fiber-optic illuminated status display
- 5 cross connection levels
- Clear marking
- Pluggable relays and SSRs
- Wide range of accessories
- CE and cULus approved

Weidmüller, Canada

10 Spy Court
Markham, Ontario L3R 5H6
Telephone: (800) 268-4080
Facsimile: (877) 300-5635
Email: info1@weidmuller.ca
Website: www.weidmuller.ca

Weidmüller, Mexico

Bldv. Hermanos Serdán 698,
Col. San Rafael Oriente
Puebla, Puebla, Mexico
C.P. 72029
Telephone: 01 222 2686267
Facsimile: 01 222 2686219
Email: clientes@weidmuller.com.mx
Website: www.weidmuller.com.mx

Weidmüller, United States

821 Southlake Blvd.
Richmond, Virginia 23236
Telephone: (800) 849-9343
Facsimile: (804) 379-2593
Email: info@weidmuller.com
Website: www.weidmuller.com

**1 CO contact
AC/DC/UC coil**

- Space saving, just 6.4 mm modular width
- AgNi contact with or without gold plating
- Screw and tension clamp connection
- 5 cross connection levels
- Multi-voltage input: 24...230 VUC in one module

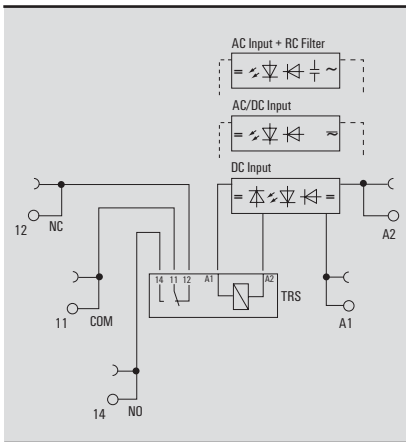
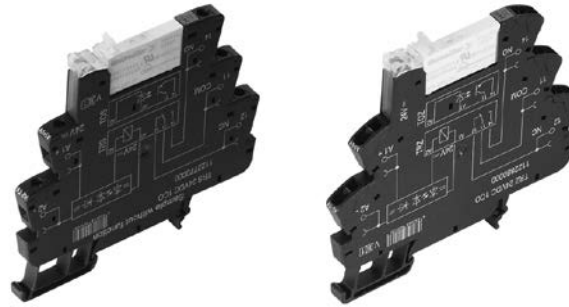

Applications

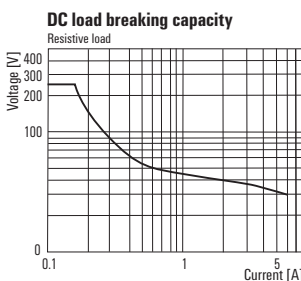
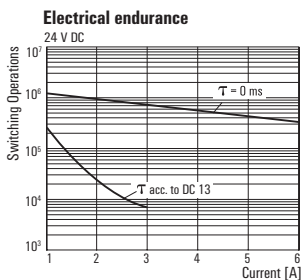
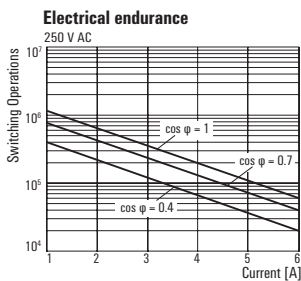

Technical data

Output	1 CO	1 CO Au
Max. switching voltage, AC / Continuous current	250 V / 6 A	
Min. switching power	100 mA / 5 V	1 mA / 1 V
Contact material	AgNi	AgNi 5µm Au
Mechanical service life	20 x 10 ⁶ switching cycles	
Max. switching frequency at rated load	0.1 Hz	
Rated data		
Status indicator	Green LED	
Reverse polarity protection	Yes	
Ambient temperature (operational)	-40 °C...+60 °C	
Storage temperature	-40 °C...+85 °C	
Humidity	5...95 % rel. humidity T ₀ = 40 °C, no condensation	
Approvals	CE, GL, cULus	
Insulation coordination (EN 50 178)		
Rated voltage	300 V	
Impulse withstand voltage	6 kV (1.2/50 µs)	
Clearance and creepage distances for control side - load side	≥ 5.5 mm	
Surge voltage category	III	
Pollution severity	2	

Dimensions	Screw connection	Tension clamp connection
Clamping range (nominal / min. / max.)	mm ² 1.5 / 0.14 / 1.5	1.5 / 0.14 / 1.5
Length x width x height	mm 88 / 6.4 / 90	88 / 6.4 / 90
Notes	Accessories and dimensional drawings: refer to the TERMSERIES Accessories page.	

Ordering data

Input	24 V - 230 V UC
Rated control voltage	24...230 V UC ±10 %
Rated current AC	4 mA @ 230 V AC ±10 % 28 mA @ 24 V AC ±10 %
Rated current DC	22 mA @ 24 V DC ±10 %
Power rating	530 mW @ 24 V DC, 930 mVA @ 230 V AC
AC Response/dropout Volt	11 V / 6 V
DC Response/dropout Volt	11 V / 5 V
AC pickup/dropout current	
DC pickup/dropout current	
Output	
Switch-on delay	< 22 ms
Switch-off delay	< 100 ms

Ordering data	Type	Part No.
Screw connection	TRS 24-230VUC 1CO	1122850000
Tension clamp connection	TRZ 24-230VUC 1CO	1122970000
Notes	Spare relay, Type: RSS113024, Part No.: 406012000	

Ordering data	Type	Part No.
Screw connection	TRS 24-230VUC 1CO AU	1123090000
Hard Gold-plated contact		
Tension clamp connection	TRZ 24-230VUC 1CO AU	1123210000
Hard Gold-plated contact		
Notes	Spare relay, Type: RSS112024, Part No.: 4061590000	

1 CO contact AC/DC/UC coil

Ordering data

Input data		5 V DC	12 V DC	24 V DC	24 V UC	48 V UC
Rated control voltage		5 V DC $\pm 20\%$	5 V DC $\pm 20\%$	24 V DC $\pm 20\%$	24 V UC $\pm 10\%$	48 V UC $\pm 10\%$
Rated current AC					10.1 mA	8 mA
Rated current DC		35.8 mA	35.8 mA	10 mA	6.4 mA	7 mA
Power rating		200 mW	200 mW	240 mW	270 mVA / 154 mW	240 mVA / 192 mW
AC Response/dropout Volt					16.6 V / 5 V	29 V / 10 V
DC Response/dropout Volt		3.3 V / 1 V	3.3 V / 1 V	16.6 V / 5 V	16.6 V / 5 V	29 V / 10 V
AC pickup/dropout current					4 mA / 1 mA	4 mA // 1.3 mA
DC pickup/dropout current		21.6 mA / 8 mA	21.6 mA / 8 mA	7 mA / 2 mA	4 mA / 1.2 mA	4 mA / 1.2 mA
Free-wheel diode		Yes	Yes	Yes	No	No
Output						
Switch-on delay		< 7 ms	< 7 ms	< 6 ms	< 4 ms	< 8 ms
Switch-off delay		< 4 ms	< 8 ms	< 7 ms	< 1.2 ms	< 4 ms
Ordering data						
Screw connection	Type	TRS 5VDC 1CO	TRS 12VDC 1CO	TRS 24VDC 1CO	TRS 24VUC 1CO	TRS 48VUC 1CO
	Part No.	1122740000	1122750000	1122770000	1122780000	1122790000
Tension clamp connection	Type	TRZ 5VDC 1CO	TRZ 12VDC 1CO	TRZ 24VDC 1CO	TRZ 24VUC 1CO	TRZ 48VUC 1CO
	Part No.	1122860000	1122870000	1122880000	1122890000	1122900000
Notes		Spare relay Type: RSS113005 Part No.: 4061580000	Spare relay Type: RSS113012 Part No.: 4061610000	Spare relay Type: RSS113024 Part No.: 4060120000	Spare relay Type: RSS113024 Part No.: 4060120000	Spare relay Type: RSS113024 Part No.: 4060120000
Ordering data						
Screw connection	Type	TRS 5VDC 1CO AU	TRS 12VDC 1CO AU	TRS 24VDC 1CO AU	TRS 24VUC 1CO AU	TRS 48VUC 1CO AU
Hard Gold-plated contact	Part No.	1122980000	1122990000	1123000000	1123010000	1123020000
Tension clamp connection	Type	TRZ 5VDC 1CO AU	TRZ 12VDC 1CO AU	TRZ 24VDC 1CO AU	TRZ 24VUC 1CO AU	TRZ 48VUC 1CO AU
Hard Gold-plated contact	Part No.	1123100000	1123110000	1123120000	1123130000	1123140000
Notes		Spare relay Type: RSS112005 Part No.: 1174540000	Spare relay Type: RSS112012 Part No.: 1220670000	Spare relay Type: RSS112024 Part No.: 4061590000	Spare relay Type: RSS112024 Part No.: 4061590000	Spare relay Type: RSS112024 Part No.: 4061590000

Ordering data

Input data		60 V UC	120 V UC	230 V UC	120 V AC RC	230 V AC RC
Rated control voltage		60 V UC $\pm 10\%$	120 V UC $\pm 10\%$	230 V UC $\pm 10\%$	120 V AC $\pm 10\%$	230 V AC $\pm 10\%$
Rated current AC		6.1 mA	4 mA	3.5 mA	7 mA	10.1 mA
Rated current DC		3.3 mA	3.5 mA	2.9 mA		
Power rating		360 mW	0.48 VA, 420 mW	0.8 VA, 700 mW	0.84 VA	2.3 VA
AC Response/dropout Volt		35 V / 11 V	79 V / 60 V	159 V / 100 V	79 V / 60 V	145 V / 90 V
DC Response/dropout Volt		40 V / 10 V		159 V / 99 V		
AC pickup/dropout current			4 mA / 2.5 mA	2.2 mA / 1.3 mA	4 mA / 2.5 mA	9.13 mA / 4.78 mA
DC pickup/dropout current				1.7 mA / 0.7 mA		
Free-wheel diode		No	No	No	No	No
Output						
Switch-on delay		< 6 ms	< 8 ms	< 22 ms	< 5.3 ms	< 22 ms
Switch-off delay		< 6.5 ms	< 7 ms	< 30 ms	< 4 ms	< 30 ms
Ordering data						
Screw connection	Type	TRS 60VUC 1CO	TRS 120VUC 1CO	TRS 230VUC 1CO	TRS 120VAC RC 1CO	TRS 230VAC RC 1CO
	Part No.	1122800000	1122810000	1122820000	1122830000	1122840000
Tension clamp connection	Type	TRZ 60VUC 1CO	TRZ 120VUC 1CO	TRZ 230VUC 1CO	TRZ 120VAC RC 1CO	TRZ 230VAC RC 1CO
	Part No.	1122910000	1122920000	1122930000	1122940000	1122950000
Notes		Spare relay Type: RSS113060 Part No.: 4061630000	Spare relay Type: RSS113060 Part No.: 4061630000	Spare relay Type: RSS113060 Part No.: 4061630000	Spare relay Type: RSS113060 Part No.: 4061630000	Spare relay Type: RSS113060 Part No.: 4061630000
Ordering data						
Screw connection	Type	TRS 60VUC 1CO AU	TRS 120VUC 1CO AU	TRS 230VUC 1CO AU	TRS 120VAC RC 1CO AU	TRS 230VAC RC 1CO AU
Hard Gold-plated contact	Part No.	1123030000	1123040000	1123050000	1123070000	1123080000
Tension clamp connection	Type	TRZ 60VUC 1CO AU	TRZ 120VUC 1CO AU	TRZ 230VUC 1CO AU	TRZ 120VAC RC 1CO AU	TRZ 230VAC RC 1CO AU
Hard Gold-plated contact	Part No.	1123150000	1123170000	1123180000	1123190000	1123200000
Notes		Spare relay Type: RSS112060 Part No.: 4061600000	Spare relay Type: RSS112060 Part No.: 4061600000	Spare relay Type: RSS112060 Part No.: 4061600000	Spare relay Type: RSS112060 Part No.: 4061600000	Spare relay Type: RSS112060 Part No.: 4061600000

**2 CO contact
AC/DC/UC coil**

- Space saving, just 12.8 mm modular width
- AgNi contact with or without gold plating
- Screw and tension clamp connection
- 5 cross connection levels
- Multi-voltage input: 24...230 VUC in one module

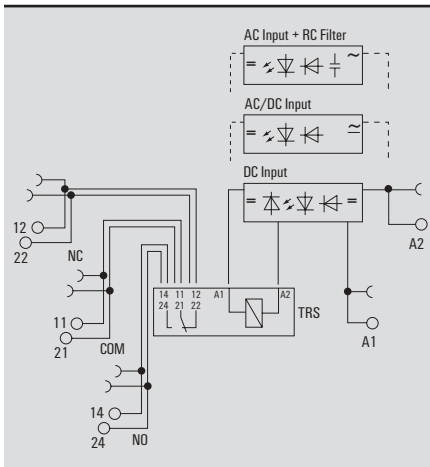
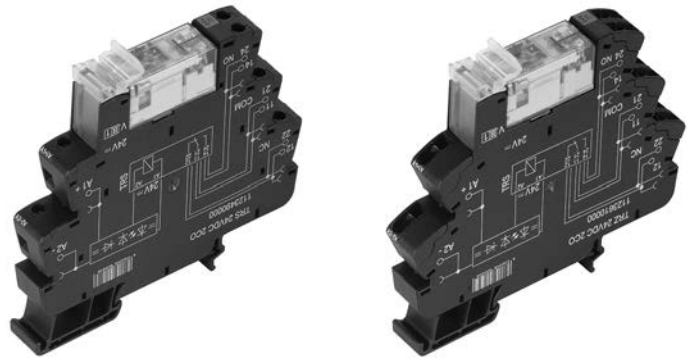

Applications

DC load breaking capacity

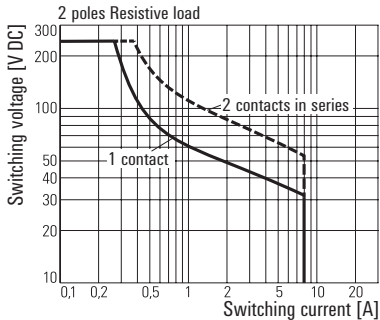

Electrical endurance

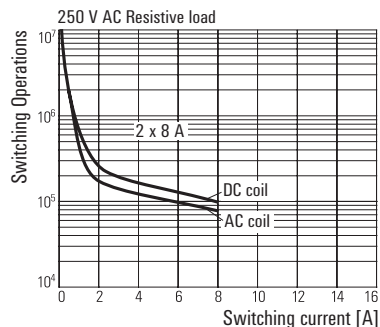

Technical data

Output	1 CO	1 CO Au
Max. switching voltage, AC / Continuous current	250 V / 8 A	
Min. switching power	10 V / 10 mA	1 V / 1 mA
Contact material	AgNi	AgNi 5µm Au
Mechanical service life	30 x 10 ⁶ switching cycles	
Max. switching frequency at rated load	0.1 Hz	
Rated data		
Status indicator	Green LED	
Reverse polarity protection	Yes	
Ambient temperature (operational)	-40 °C...+60 °C	
Storage temperature	-40 °C...+85 °C	
Humidity	5...95 % rel. humidity T ₀ = 40 °C, no condensation	
Approvals	CE, GL, cULus	
Insulation coordination (EN 50 178)		
Rated voltage	300 V	
Impulse withstand voltage	6 kV (1.2/50 µs)	
Clearance and creepage distances for control side - load side	≥ 5.5 mm	
Surge voltage category	III	
Pollution severity	2	

Dimensions	Screw connection	Tension clamp connection
Clamping range (nominal / min. / max.)	mm ² 1.5 / 0.14 / 1.5	1.5 / 0.14 / 1.5
Length x width x height	mm 88 / 12.8 / 90	88 / 12.8 / 90
Notes	Accessories and dimensional drawings: refer to the TERMSERIES Accessories page.	

Ordering data

Input	24 V - 230 V UC
Rated control voltage	24...230 V UC ±10 %
Rated current AC	6 mA @ 230 V AC
Rated current DC	45 mA @ 24 V DC
Power rating	530 mW @ 24 V DC, 930 mVA @ 230 V AC
AC Response/dropout Volt	16.6 V / 5 V
DC Response/dropout Volt	16.6 V / 5 V
AC pickup/dropout current	
DC pickup/dropout current	
Output	
Switch-on delay	< 22 ms
Switch-off delay	< 100 ms

Ordering data	Type	Part No.
Screw connection	TRS 24-230VUC 2CO	1123580000
Tension clamp connection	TRZ 24-230VUC 2CO	1123700000
Notes	Spare relay, Type: RCL424024, Part No.: 4058570000	

Ordering data	Type	Part No.
Screw connection	TRS 24-230VUC 2CO AU	1123820000
Hard Gold-plated contact		
Tension clamp connection	TRZ 24-230VUC 2CO AU	1123940000
Hard Gold-plated contact		
Notes	Spare relay, Type: RCL425024, Part No.: 4058580000	

2 CO contact AC/DC/UC coil

Ordering data

Input data		5 V DC	12 V DC	24 V DC	24 V UC	48 V UC
Rated control voltage		5 V DC $\pm 20\%$	12 V DC $\pm 20\%$	24 V DC $\pm 20\%$	24 V UC $\pm 10\%$	48 V UC $\pm 10\%$
Rated current AC					16 mA	9 mA
Rated current DC		80 mA	33.3 mA	16 mA	14 mA	7 mA
Power rating		400 mW	420 mW	384 mW	390 mVA / 350 mW	340 mW / 0.4 VA
AC Response/dropout Volt					16 V / 9 V	29 V / 11 V
DC Response/dropout Volt		3.2 V / 1.6 V	8.5 V / 3 V	16.6 V / 3.5 V	18 V / 8 V	33 V / 12 V
AC pickup/dropout current					11 mA / 4 mA	6.3 mA / 4.3 mA
DC pickup/dropout current		21.6 mA / 8 mA	21 mA / 5 mA	10 mA / 2 mA	10 mA / 2 mA	5 mA / 2 mA
Free-wheel diode		Yes	Yes	Yes	No	No
Output						
Switch-on delay		< 7 ms	< 7 ms	< 8 ms	< 4 ms	< 8 ms
Switch-off delay		< 4 ms	< 8 ms	< 10 ms	< 1.2 ms	< 4 ms
Ordering data						
Screw connection	Type	TRS 5VDC 2CO	TRS 12VDC 2CO	TRS 24VDC 2CO	TRS 24VUC 2CO	TRS 48VUC 2CO
	Part No.	1123470000	1123480000	1123490000	1123500000	1123510000
Tension clamp connection	Type	TRZ 5VDC 2CO	TRZ 12VDC 2CO	TRZ 24VDC 2CO	TRZ 24VUC 2CO	TRZ 48VUC 2CO
	Part No.	1123590000	1123600000	1123610000	1123620000	1123630000
Notes		Spare relay Type: RCL424005 Part No.: 8693790000	Spare relay Type: RCL424012 Part No.: 4058560000	Spare relay Type: RCL424024 Part No.: 4058570000	Spare relay Type: RCL424024 Part No.: 4058570000	Spare relay Type: RCL424048 Part No.: 4058750000
Ordering data						
Screw connection	Type	TRS 5VDC 2CO AU	TRS 12VDC 2CO AU	TRS 24VDC 2CO AU	TRS 24VUC 2CO AU	TRS 48VUC 2CO AU
Hard Gold-plated contact	Part No.	1123710000	1123720000	1123730000	1123740000	1123750000
Tension clamp connection	Type	TRZ 5VDC 2CO AU	TRZ 12VDC 2CO AU	TRZ 24VDC 2CO AU	TRZ 24VUC 2CO AU	TRZ 48VUC 2CO AU
Hard Gold-plated contact	Part No.	1123830000	1123840000	1123850000	1123870000	1123880000
Notes		Spare relay Type: RCL425005 Part No.: 1174490000	Spare relay Type: RCL425012 Part No.: 4074580000	Spare relay Type: RCL425024 Part No.: 4058580000	Spare relay Type: RCL425024 Part No.: 4058580000	Spare relay Type: RCL425048 Part No.: 1201230000

Ordering data

Input data		60 V UC	120 V UC	230 V UC	120 V AC RC	230 V AC RC
Rated control voltage		60 V UC $\pm 10\%$	120 V UC $\pm 10\%$	230 V UC $\pm 5\%$	120 V AC $\pm 10\%$	230 V AC $\pm 5\%$
Rated current AC		8 mA	3.5 mA	4 mA	6.1 mA	10.1 mA
Rated current DC		6.1 mA	3.5 mA	4 mA		
Power rating		480 mVA / 360 mW	420 mVA / 420 mW	920 mVA / 920 mW	0.73 VA	2.3 VA
AC Response/dropout Volt		36 V / 13 V	64 V / 26 V	112 / 43 V	65 V / 23 V	112 V / 45 V
DC Response/dropout Volt		40 / 14 V	69 V / 22 V	129 V / 36 V		
AC pickup/dropout current		5 mA / 2.5 mA	2 mA / 1 mA	2 mA / 1 mA	3.6 mA / 1.3 mA	5 mA / 2.5 mA
DC pickup/dropout current		4 mA / 1.2 mA	2 mA / 1 mA	2 mA / 1 mA		
Free-wheel diode		No	No	No	No	No
Output						
Switch-on delay		< 6 ms	< 8 ms	< 14 ms	< 5 ms	< 14 ms
Switch-off delay		< 7 ms	< 7 ms	< 22 ms	< 4 ms	< 12 ms
Ordering data						
Screw connection	Type	TRS 60 VUC 2CO	TRS 120VUC 2CO	TRS 230VUC 2CO	TRS 120VAC RC 2CO	TRS 230VAC RC 2CO
	Part No.	1123520000	1123530000	1123540000	1123550000	1123570000
Tension clamp connection	Type	TRZ 60VUC 2CO	TRZ 120VUC 2CO	TRZ 230VUC 2CO	TRZ 120VAC RC 2CO	TRZ 230VAC RC 2CO
	Part No.	1123640000	1123650000	1123670000	1123680000	1123690000
Notes		Spare relay Type: RCL424060 Part No.: 4058760000	Spare relay Type: RCL424110 Part No.: 4058590000	Spare relay Type: RCL424110 Part No.: 4058590000	Spare relay Type: RCL424110 Part No.: 4058590000	Spare relay Type: RCL424110 Part No.: 4058590000
Ordering data						
Screw connection	Type	TRS 60 VUC 2CO AU	TRS 120VUC 2CO AU	TRS 230VUC 2CO AU	TRS 120VAC RC 2CO AU	TRS 230VAC RC 2CO AU
Hard Gold-plated contact	Part No.	1123770000	1123780000	1123790000	1123800000	1123810000
Tension clamp connection	Type	TRZ 60VUC 2CO AU	TRZ 120VUC 2CO AU	TRZ 230VUC 2CO AU	TRZ 120VAC RC 2CO AU	TRZ 230VAC RC 2CO AU
Hard Gold-plated contact	Part No.	1123890000	1123900000	1123910000	1123920000	1123930000
Notes		Spare relay Type: RC425060 Part No.: 1201260000	Spare relay Type: RCL425110 Part No.: 8828370000	Spare relay Type: RCL425110 Part No.: 8828370000	Spare relay Type: RCL425110 Part No.: 8828370000	Spare relay Type: RCL425110 Part No.: 8828370000

**Solid-state relays,
3 - 48 V DC / 100 mA**

Output versions

- Space saving, just 6.4 mm modular width
- 5 cross-connection levels
- Screw and tension clamp connection
- Multi-voltage input: 24...230 VUC in one module

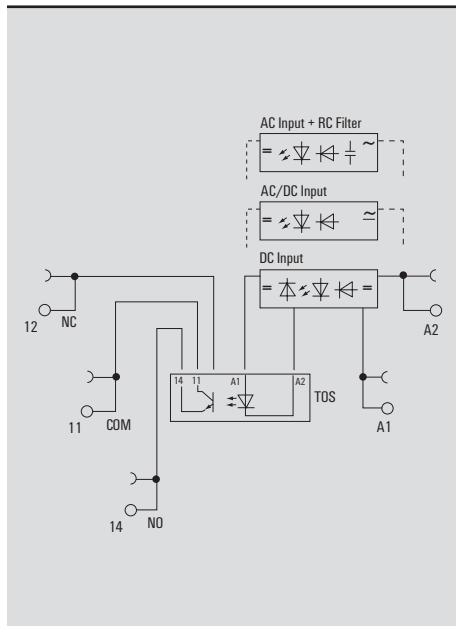
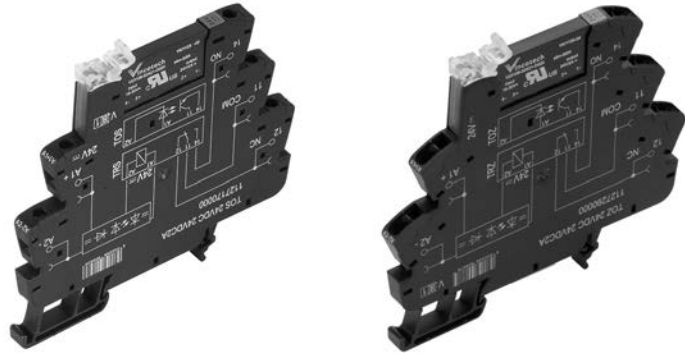

Technical data

Load side	
Solid-state type	Bipolar transistor
Nominal switching voltage / current	3 V...48 V DC / 100 mA
Voltage drop at max. load	≤ 1 V
Short-circuit-proof / Protective circuit, load side	No / Integrated free-wheel diode
Continuous current	100 mA
General data	
Ambient temperature (operational)	-40 °C...+60 °C
Storage temperature	-40 °C...+85 °C
Humidity	5...95 % rel. humidity T _h = 40 °C, no condensation
Approvals	CE, GL, cULus
Insulation coordination (EN 50 178)	
Rated voltage	300 V
Rated impulse withstand voltage	6 kV (1.2/50 μs)
Clearance and creepage distances for control side - load side	≥ 5.5 mm
Surge voltage category	III
Pollution severity	2

Dimensions	Screw connection	Tension clamp connection
Clamping range (nominal / min. / max.)	mm ² 1.5 / 0.14 / 1.5	1.5 / 0.14 / 1.5
Length x width x height	mm 88 / 6.4 / 90	88 / 6.4 / 90
Notes	Accessories and dimensional drawings: refer to the TERMSERIES Accessories page.	

Ordering data

Control side	
24 V - 230 V UC	
Rated control voltage	24...230 V UC ±10 %
Nominal control current	22 mA @ 24 V DC, 4 mA @ 230 V AC
Power rating	530 mW @ 24 V DC, 930 mVA @ 230 V AC
Cut-in (switch-on) voltage	≥ 9.6 V AC, ≥ 9.6 V DC
Dropout voltage	≤ 7.5 V AC, ≤ 6 V DC
Input frequency	3 Hz
Status indicator	Green LED
Protective circuit	Rectifier
Load side	
Switch-on delay	< 22 ms
Switch-off delay	< 100 ms

Ordering data	Type	Part No.
Screw connection	TOS 24-230VUC 48VDC 0.1A	1127020000
Tension clamp connection	TOZ 24-230VUC 48VDC 0.1A	1127130000
Notes	Spare solid-state relay, Type: SSS 24 V/24 V 0.1A DC, Part No.: 4061180000	

Solid-state relays, 3 - 48 V DC / 100 mA Output versions

Ordering data

Control side		5 V DC	12 V DC	24 V DC	24 V UC	48 V UC
Rated control voltage		5 V DC $\pm 20\%$	12 V DC $\pm 20\%$	24 V DC $\pm 20\%$	24 V UC $\pm 10\%$	48 V UC $\pm 10\%$
Nominal control current		7 mA DC ($\pm 20\%$)	9.6 mA DC ($\pm 20\%$)	10 mA DC $\pm 20\%$	10 mA AC $\pm 20\%$, 6 mA DC ($\pm 20\%$)	8 mA AC ($\pm 20\%$), 7 mA DC ($\pm 20\%$)
Power rating		35 mW	112 mW	240 mW	154 mW	290 mVA / 192 mW
Cut-in (switch-on) voltage		≥ 3 V DC	≥ 4 V DC	≥ 15 V DC	≥ 14.4 V AC, ≥ 11.2 V DC	≥ 28 V AC, ≥ 28 V DC
Dropout voltage		≤ 1.7 V DC	≤ 6 V DC	≤ 15 V DC	≤ 15.7 V AC, ≤ 15.7 V DC	≤ 24 V AC, ≤ 24 V DC
Input frequency		10 Hz	10 Hz	300 Hz	DC: 100 Hz / AC: 3 Hz	DC: 100 Hz / AC: 3 Hz
Status indicator		Green LED	Green LED	Green LED	Green LED	Green LED
Protective circuit		Reverse polarity protection, Integrated free-wheel diode	Reverse polarity protection, Integrated free-wheel diode	Reverse polarity protection, Integrated free-wheel diode	Rectifier	Rectifier
Load side						
Switch-on delay		< 6.5 ms	< 6.5 ms	< 35 μ s	< 55 μ s	< 55 μ s
Switch-off delay		< 10 ms	< 10 ms	< 355 μ s	< 4 ms	< 4 ms
Ordering data						
Screw connection	Type	TOS 5VDC 48VDC0,1A	TOS 12VDC 48VDC0,1A	TOS 24VDC 48VDC0,1A	TOS 24VUC 48VDC0,1A	TOS 48VUC 48VDC0,1A
	Part No.	1126920000	1126930000	1126940000	1126950000	1126960000
Tension clamp connection	Type	TOZ 5VDC 48VDC0,1A	TOZ 12VDC 48VDC0,1A	TOZ 24VDC 48VDC0,1A	TOZ 24VUC 48VDC0,1A	TOZ 48VUC 48VDC0,1A
	Part No.	1127030000	1127040000	1127050000	1127060000	1127070000
Notes		Spare solid-state relay Type: SSS 5 V/24 V 0.1A DC Part No.: 4064320000	Spare solid-state relay Type: SSS 5 V/24 V 0.1A DC Part No.: 4064320000	Spare solid-state relay Type: SSS 24 V/24 V 0.1A DC Part No.: 4061180000	Spare solid-state relay Type: SSS 24 V/24 V 0.1A DC Part No.: 4061180000	Spare solid-state relay Type: SSS 24 V/24 V 0.1A DC Part No.: 4061180000

Ordering data

Control side		60 V UC	120 V UC	230 V UC	120 V AC RC	230 V AC RC
Rated control voltage		60 V UC $\pm 10\%$	120 V UC $\pm 10\%$	230 V UC $\pm 10\%$	120 V AC $\pm 10\%$	230 V AC $\pm 10\%$
Nominal control current		5 mA AC ($\pm 20\%$), 3 mA DC ($\pm 20\%$)	5 mA AC ($\pm 30\%$), 3 mA DC ($\pm 30\%$)	3.5 mA AC ($\pm 30\%$), 3 mA DC ($\pm 30\%$)	7 mA AC ($\pm 20\%$)	9 mA AC
Power rating		< 300 mW	0.48 VA	0.8 VA / 660 mW	0.84 VA	2.1 VA
Cut-in (switch-on) voltage		≥ 28 V AC, ≥ 28 V DC	≥ 65 V AC, ≥ 63 V DC	≥ 130 V AC, ≥ 107 V DC	≥ 65 V AC	≥ 103 V AC
Dropout voltage		≤ 24 V AC, ≤ 31.2 V DC	≤ 78 V AC, ≤ 89 V DC	≤ 126 V AC, ≤ 153 V DC	≤ 71.5 V AC	≤ 109 V AC
Input frequency		DC: 10 Hz / AC: 3 Hz	3 Hz	3 Hz	3 Hz	3 Hz
Status indicator		Green LED	Green LED	Green LED	Green LED	Green LED
Protective circuit		Rectifier	Rectifier	Rectifier	RC element	RC element
Load side						
Switch-on delay		< 6.5 ms	< 6.5 ms	< 7 ms	< 6.5 ms	< 7 ms
Switch-off delay		< 10 ms	< 10 ms	< 10 ms	< 10 ms	< 10 ms
Ordering data						
Screw connection	Type	TOS 60VUC 48VDC0,1A	TOS 120VUC 48VDC0,1A	TOS 230VUC 48VDC0,1A	TOS 120VAC RC 48VDC0,1A	TOS 230VAC RC 48VDC0,1A
	Part No.	1126970000	1126980000	1126990000	1127000000	1127010000
Tension clamp connection	Type	TOZ 60VUC 48VDC0,1A	TOZ 120VUC 48VDC0,1A	TOZ 230VUC 48VDC0,1A	TOZ 120VAC RC 48VDC0,1A	TOZ 230VAC RC 48VDC0,1A
	Part No.	1127080000	1127090000	1127100000	1127110000	1127120000
Notes		Spare solid-state relay Type: SSS 60 V/24 V 0.1A DC Part No.: 4061230000	Spare solid-state relay Type: SSS 60 V/24 V 0.1A DC Part No.: 4061230000	Spare solid-state relay Type: SSS 60 V/24 V 0.1A DC Part No.: 4061230000	Spare solid-state relay Type: SSS 60 V/24 V 0.1A DC Part No.: 4061230000	Spare solid-state relay Type: SSS 60 V/24 V 0.1A DC Part No.: 4061230000

**Solid-state relays,
3 - 33 V DC / 2 A**
Output versions

- Space saving, just 6.4 mm modular width
- 5 cross-connection levels
- Screw and tension clamp connection
- Multi-voltage input: 24...230 VUC in one module

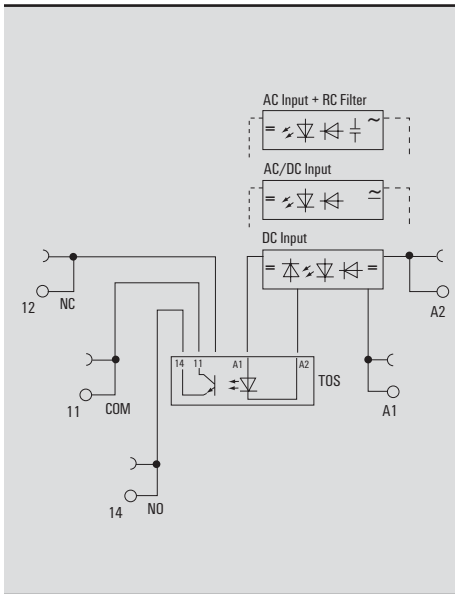
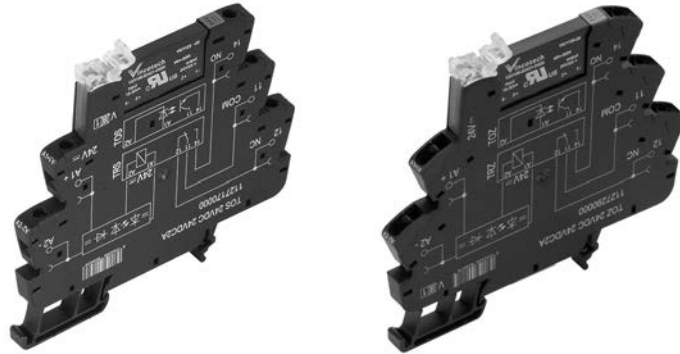

Technical data

Load side	
Solid-state type	POWER MOS-FET
Nominal switching voltage / current	3 V...33 V DC / 2 A
Voltage drop at max. load	≤ 120 mV
Short-circuit-proof / Protective circuit, load side	No / Integrated free-wheel diode
Continuous current	2 A
General data	
Ambient temperature (operational)	-40 °C...+60 °C
Storage temperature	-40 °C...+85 °C
Humidity	5...95 % rel. humidity T ₀ = 40 °C, no condensation
Approvals	CE, GL, cULus
Insulation coordination (EN 50 178)	
Rated voltage	300 V
Rated impulse withstand voltage	6 kV (1.2/50 μs)
Clearance and creepage distances for control side - load side	≥ 5.5 mm
Surge voltage category	III
Pollution severity	2
Dimensions	
Clamping range (nominal / min. / max.)	mm ² 1.5 / 0.14 / 1.5
Length x width x height	mm 88 / 6.4 / 90
Notes	
Accessories and dimensional drawings: refer to the TERMSERIES Accessories page.	

Ordering data

Control side		24 V - 230 V UC
Rated control voltage	24...230 V UC ±10 %	
Nominal control current	22 mA @ 24 V DC, 4 mA @ 230 V AC	
Power rating	530 mW @ 24 V DC, 930 mVA @ 230 V AC	
Cut-in (switch-on) voltage	≥ 9.6 V AC, ≥ 9.6 V DC	
Dropout voltage	≤ 7.5 V AC, ≤ 6 V DC	
Input frequency	3 Hz	
Status indicator	Green LED	
Protective circuit	Rectifier	
Load side		
Switch-on delay	< 20 ms	
Switch-off delay	< 100 ms	
Ordering data		Part No.
Screw connection	TOS 24-230VUC 24VDC2A	1127250000
Tension clamp connection	TOZ 24-230VUC 24VDC2A	1127380000
Notes		Spare solid-state relay, Type: SSS 24 V/24 V 2 A DC, Part No.: 4061190000

Solid-state relays, 3 - 33 V DC / 2 A Output versions

Ordering data

Control side		5 V DC	12 V DC	24 V DC	24 V UC	48 V UC
Rated control voltage		5 V DC $\pm 20\%$	12 V DC $\pm 20\%$	24 V DC $\pm 20\%$	24 V UC $\pm 10\%$	48 V UC $\pm 10\%$
Nominal control current		10 mA DC $\pm 20\%$	9.6 mA DC ($\pm 20\%$)	10 mA DC $\pm 20\%$	10 mA AC $\pm 20\%$, 6 mA DC ($\pm 20\%$)	8 mA AC ($\pm 20\%$), 7 mA DC ($\pm 20\%$)
Power rating		50 mW	112 mW	240 mW	154 mW	290 mVA / 192 mW
Cut-in (switch-on) voltage		≥ 3 V DC	≥ 4 V DC	≥ 15 V DC	≥ 14.4 V AC, ≥ 11.2 V DC	≥ 28 V AC, ≥ 28 V DC
Dropout voltage		≤ 1.7 V DC	≤ 6 V DC	≤ 15 V DC	≤ 15.7 V AC, ≤ 15.7 V DC	≤ 24 V AC, ≤ 24 V DC
Input frequency		300 Hz	300 Hz	300 Hz	DC: 10 Hz / AC: 3 Hz	DC: 10 Hz / AC: 3 Hz
Status indicator		Green LED	Green LED	Green LED	Green LED	Green LED
Protective circuit		Reverse polarity protection, Integrated free-wheel diode	Reverse polarity protection, Integrated free-wheel diode	Reverse polarity protection, Integrated free-wheel diode	Rectifier	Rectifier
Load side						
Switch-on delay		< 55 μ s	< 55 μ s	< 55 μ s	< 6.5 ms	< 6.5 ms
Switch-off delay		< 1 ms	< 1.2 ms	< 1.2 ms	< 10 ms	< 10 ms
Ordering data						
Screw connection	Type	TOS 5VDC 24VDC2A	TOS 12VDC 24VDC2A	TOS 24VDC 24VDC2A	TOS 24VUC 24VDC2A	TOS 48VUC 24VDC2A
	Part No.	1127140000	1127150000	1127170000	1127180000	1127190000
Tension clamp connection	Type	TOZ 5VDC 24VDC2A	TOZ 12VDC 24VDC2A	TOZ 24VDC 24VDC2A	TOZ 24VUC 24VDC2A	TOZ 48VUC 24VDC2A
	Part No.	1127270000	1127280000	1127290000	1127300000	1127310000
Notes		Spare solid-state relay Type: SSS 5 V/24 V 2 A DC Part No.: 4064310000	Spare solid-state relay Type: SSS 5 V/24 V 2 A DC Part No.: 4064310000	Spare solid-state relay Type: SSS 24 V/24 V 2 A DC Part No.: 4061190000	Spare solid-state relay Type: SSS 24 V/24 V 2 A DC Part No.: 4061190000	Spare solid-state relay Type: SSS 24 V/24 V 2 A DC Part No.: 4061190000

Ordering data

Control side		60 V UC	120 V UC	230 V UC	120 V AC RC	230 V AC RC
Rated control voltage		60 V UC $\pm 10\%$	120 V UC $\pm 10\%$	230 V UC $\pm 10\%$	120 V AC $\pm 10\%$	230 V AC $\pm 10\%$
Nominal control current		5 mA AC ($\pm 20\%$), 3 mA DC ($\pm 20\%$)	5 mA AC ($\pm 30\%$), 3 mA DC ($\pm 30\%$)	3.5 mA AC ($\pm 30\%$), 3 mA DC ($\pm 30\%$)	7 mA AC ($\pm 20\%$)	9 mA AC
Power rating		< 300 mW	0.48 VA	0.8 VA / 660 mW	0.84 VA	2.1 VA
Cut-in (switch-on) voltage		≥ 28 V AC, ≥ 28 V DC	≥ 65 V AC, ≥ 63 V DC	≥ 130 V AC, ≥ 107 V DC	≥ 65 V AC	≥ 103 V AC
Dropout voltage		≤ 24 V AC, ≤ 31.2 V DC	≤ 78 V AC, ≤ 89 V DC	≤ 126 V AC, ≤ 153 V DC	≤ 71.5 V AC	≤ 109 V AC
Input frequency		DC: 10 Hz / AC: 3 Hz	3 Hz	3 Hz	3 Hz	3 Hz
Status indicator		Green LED	Green LED	Green LED	Green LED	Green LED
Protective circuit		Rectifier	Rectifier	Rectifier	RC element	RC element
Load side						
Switch-on delay		< 6.5 ms	< 6.5 ms	< 7 ms	< 6.5 ms	< 7 ms
Switch-off delay		< 10 ms	< 10 ms	< 10 ms	< 10 ms	< 10 ms
Ordering data						
Screw connection	Type	TOS 60VUC 24VDC2A	TOS 120VUC 24VDC2A	TOS 230VUC 24VDC2A	TOS 120VAC RC 24VDC2A	TOS 230VAC RC 24VDC2A
	Part No.	1127200000	1127210000	1127220000	1127230000	1127240000
Tension clamp connection	Type	TOZ 60VUC 24VDC2A	TOZ 120VUC 24VDC2A	TOZ 230VUC 24VDC2A	TOZ 120VAC RC 24VDC2A	TOZ 230VAC RC 24VDC2A
	Part No.	1127320000	1127330000	1127340000	1127350000	1127370000
Notes		Spare solid-state relay Type: SSS 60 V/24 V 2 A DC Part No.: 4061200000	Spare solid-state relay Type: SSS 60 V/24 V 2 A DC Part No.: 4061200000	Spare solid-state relay Type: SSS 60 V/24 V 2 A DC Part No.: 4061200000	Spare solid-state relay Type: SSS 60 V/24 V 2 A DC Part No.: 4061200000	Spare solid-state relay Type: SSS 60 V/24 V 2 A DC Part No.: 4061200000

Solid-state relays, 24 - 230 V AC / 1 A

Output versions

- Space saving, just 6.4 mm modular width
- 5 cross-connection levels
- Screw and tension clamp connection
- Multi-voltage input: 24...230 VUC in one module

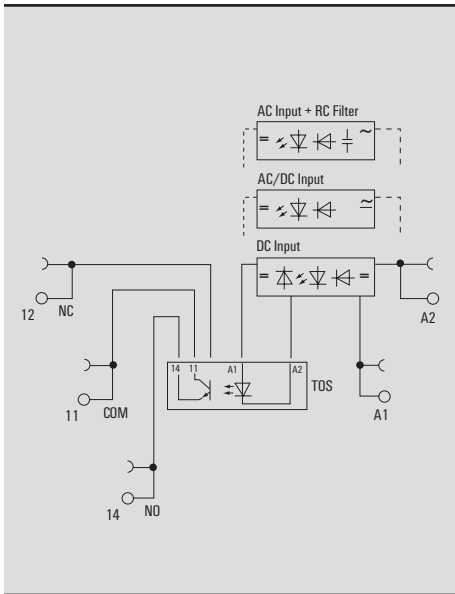
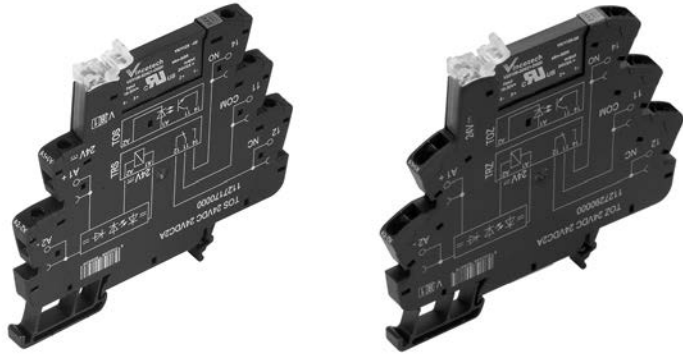

Technical data

Load side			
Solid-state type	Triac		
Nominal switching voltage / current	24 V AC ... 250 V AC / min. 20 mA / max. 1 A		
Voltage drop at max. load	≤ 1.6 V		
Short-circuit-proof / Protective circuit, load side	No / No		
Continuous current	1 A		
General data			
Ambient temperature (operational)	-40 °C...+60 °C		
Storage temperature	-40 °C...+85 °C		
Humidity	5...95 % rel. humidity T ₉₀ = 40 °C, no condensation		
Approvals	CE, GL, cULus		
Insulation coordination (EN 50 178)			
Rated voltage	300 V		
Rated impulse withstand voltage	6 kV (1.2/50 μs)		
Clearance and creepage distances for control side - load side	≥ 5.5 mm		
Surge voltage category	III		
Pollution severity	2		
Dimensions			
Screw connection			
Tension clamp connection			
Clamping range (nominal / min. / max.)	mm ²	1.5 / 0.14 / 1.5	1.5 / 0.14 / 1.5
Length x width x height	mm	88 / 6.4 / 90	88 / 6.4 / 90
Notes			
Accessories and dimensional drawings: refer to the TERMSERIES Accessories page.			

Ordering data

Control side		24 V - 230 V UC	
Rated control voltage		24...230 V UC ±10 %	
Nominal control current		22 mA @ 24 V DC, 4 mA @ 230 V AC	
Power rating		530 mW @ 24 V DC, 930 mVA @ 230 V AC	
Cut-in (switch-on) voltage		≥ 9.6 V AC, ≥ 9.6 V DC	
Dropout voltage		≤ 7.5 V AC, ≤ 6 V DC	
Input frequency		3 Hz	
Status indicator		Green LED	
Protective circuit		Rectifier	
Load side			
Switch-on delay		< 20 ms	
Switch-off delay		< 100 ms	
Ordering data		Type	
Screw connection		TOS 24-230VUC 230VAC1A	1127500000
Tension clamp connection		TOZ 24-230VUC 230VAC1A	1127620000
Notes		Part No.	
Spare solid-state relay, Type: SSS 24 V/230 V 1 A AC, Part No.:		4061210000	

Solid-state relays, 24 - 230 V AC / 1 A Output versions

Ordering data

Control side		5 V DC	12 V DC	24 V DC	24 V UC	48 V UC
Rated control voltage		5 V DC $\pm 20\%$	12 V DC $\pm 20\%$	24 V DC $\pm 20\%$	24 V UC $\pm 10\%$	48 V UC $\pm 10\%$
Nominal control current		15 mA DC ($\pm 20\%$)	9.6 mA DC ($\pm 20\%$)	10 mA DC $\pm 20\%$	10 mA AC $\pm 20\%$, 6 mA DC ($\pm 20\%$)	6 mA AC ($\pm 20\%$), 4 mA DC ($\pm 20\%$)
Power rating		75 mW	112 mW	260 mW	154 mW	290 mVA / 192 mW
Cut-in (switch-on) voltage		≥ 3 V DC	≥ 4 V DC	≥ 15 V DC	≥ 14.4 V AC, ≥ 11.2 V DC	≥ 28 V AC, ≥ 28 V DC
Dropout voltage		≤ 1.7 V DC	≤ 6 V DC	≤ 15 V DC	≤ 15.7 V AC, ≤ 15.7 V DC	≤ 24 V AC, ≤ 24 V DC
Input frequency		3 Hz	3 Hz	3 Hz	3 Hz	3 Hz
Status indicator		Green LED	Green LED	Green LED	Green LED	Green LED
Protective circuit		Reverse polarity protection, Integrated free-wheel diode	Reverse polarity protection, Integrated free-wheel diode	Reverse polarity protection, Integrated free-wheel diode	Rectifier	Rectifier
Load side						
Switch-on delay		< 12 ms	< 12 ms	< 11 ms	< 11 ms	< 11 ms
Switch-off delay		< 12 ms	< 12 ms	< 11 ms	< 11 ms	< 11 ms
Ordering data						
Screw connection	Type Part No.	TOS 5VDC 230VAC1A 1127390000	TOS 12VDC 230VAC1A 1127400000	TOS 24VDC 230VAC1A 1127410000	TOS 24VUC 230VAC1A 1127420000	TOS 48VUC 230VAC1A 1127430000
Tension clamp connection	Type Part No.	TOZ 5VDC 230VAC1A 1127510000	TOZ 12VDC 230VAC1A 1127520000	TOZ 24VDC 230VAC1A 1127530000	TOZ 24VUC 230VAC1A 1127540000	TOZ 48VUC 230VAC1A 1127550000
Notes		Spare solid-state relay Type: SSS 5 V/230 V 1 A AC Part No.: 1132260000	Spare solid-state relay Type: SSS 5 V/230 V 1 A AC Part No.: 1132260000	Spare solid-state relay Type: SSS 24 V/230 V 1 A AC Part No.: 4061210000	Spare solid-state relay Type: SSS 24 V/230 V 1 A AC Part No.: 4061210000	Spare solid-state relay Type: SSS 24 V/230 V 1 A AC Part No.: 4061210000

Ordering data

Control side		60 V UC	120 V UC	230 V UC	120 V AC RC	230 V AC RC
Rated control voltage		60 V UC $\pm 10\%$	120 V UC $\pm 10\%$	230 V UC +5 %/ -10 %	120 V AC $\pm 10\%$	230 V AC $\pm 10\%$
Nominal control current		5 mA AC ($\pm 20\%$), 3 mA DC ($\pm 20\%$)	5 mA AC ($\pm 30\%$), 3 mA DC ($\pm 30\%$)	3.5 mA AC ($\pm 30\%$), 3 mA DC ($\pm 30\%$)	7 mA AC ($\pm 20\%$)	9 mA AC
Power rating		< 300 mW	0.48 VA	0.8 VA / 660 mW	0.84 VA	2.1 VA
Cut-in (switch-on) voltage		≥ 28 V AC, ≥ 28 V DC	≥ 65 V AC, ≥ 63 V DC	≥ 130 V AC, ≥ 107 V DC	≥ 65 V AC	≥ 103 V AC
Dropout voltage		≤ 22 V AC, ≤ 28.6 V DC	≤ 78 V AC, ≤ 89 V DC	≤ 126 V AC, ≤ 153 V DC	≤ 71.5 V AC	≤ 109 V AC
Input frequency		3 Hz	3 Hz	3 Hz	3 Hz	3 Hz
Status indicator		Green LED	Green LED	Green LED	Green LED	Green LED
Protective circuit		Rectifier	Rectifier	Rectifier	RC element	RC element
Load side						
Switch-on delay		< 11 ms	< 11 ms	< 20 ms	< 11 ms	< 20 ms
Switch-off delay		< 11 ms	< 11 ms	< 20 ms	< 11 ms	< 20 ms
Ordering data						
Screw connection	Type Part No.	TOS 60VUC 230VAC1A 1127440000	TOS 120VUC 230VAC1A 1127450000	TOS 230VUC 230VAC1A 1127470000	TOS 120VAC RC 230VAC1A 1127480000	TOS 230VAC RC 230VAC1A 1127490000
Tension clamp connection	Type Part No.	TOZ 60VUC 230VAC1A 1127570000	TOZ 120VUC 230VAC1A 1127580000	TOZ 230VUC 230VAC1A 1127590000	TOZ 120VAC RC 230VAC1A 1127600000	TOZ 230VAC RC 230VAC1A 1127610000
Notes		Spare solid-state relay Type: SSS 60 V/230 V 1 A AC Part No.: 4061220000	Spare solid-state relay Type: SSS 60 V/230 V 1 A AC Part No.: 4061220000	Spare solid-state relay Type: SSS 60 V/230 V 1 A AC Part No.: 4061220000	Spare solid-state relay Type: SSS 60 V/230 V 1 A AC Part No.: 4061220000	Spare solid-state relay Type: SSS 60 V/230 V 1 A AC Part No.: 4061220000

**Solid-state relays,
0 - 33 V DC / 3.5 A
12 - 275 V AC / 1 A
Output versions**

- Space saving, just 12.8 mm modular width
- 5 cross-connection levels
- Screw and tension clamp connection
- Multi-voltage input: 24...230 VUC in one module

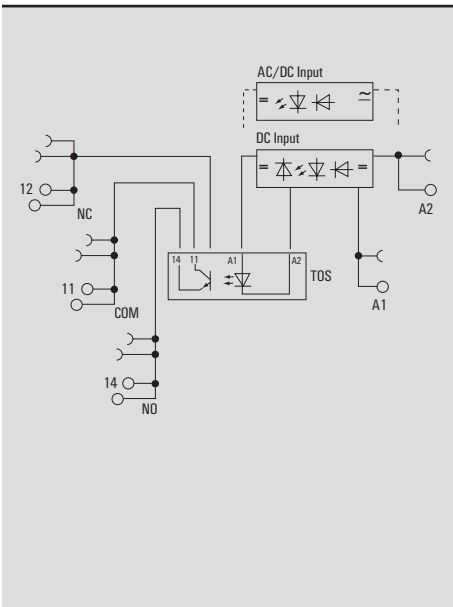
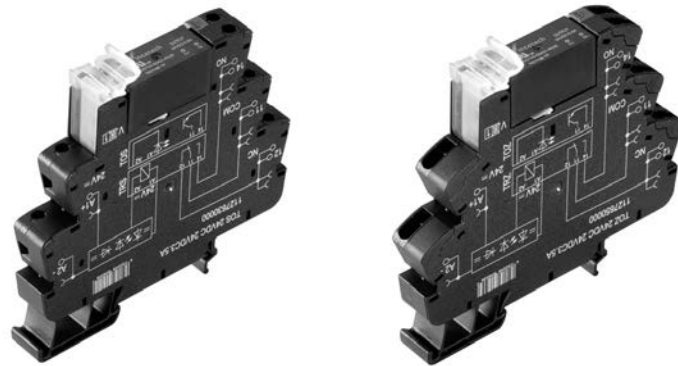

Technical data

	0-33 V DC / 3.5 A	12-275 V AC / 1 A
Load side		
Solid-state type	Bipolar transistor	Triac
Nominal switching voltage / current	3...33 V DC / 3.5 A	12-275 V AC / 1 A
Voltage drop at max. load	≤ 0.3 V	≤ 1.1 V
Short-circuit-proof / Protective circuit, load side	No / Integrated free-wheel diode	No / No
Continuous current	3.5 A	1 A
General data		
Ambient temperature (operational)	-40 °C...+60 °C	
Storage temperature	-40 °C...+85 °C	
Humidity	5...95 % rel. humidity T _u = 40 °C, no condensation	
Approvals	CE, GL, cULus	
Insulation coordination (EN 50 178)		
Rated voltage	300 V	
Rated impulse withstand voltage	6 kV (1.2/50 μs)	
Clearance and creepage distances for control side - load side	≥ 5.5 mm	
Surge voltage category	III	
Pollution severity	2	
Dimensions	Screw connection	Tension clamp connection
Clamping range (nominal / min. / max.)	mm ² 1.5 / 0.14 / 1.5	1.5 / 0.14 / 1.5
Length x width x height	mm 88 / 12.8 / 90	88 / 12.8 / 90
Notes	Accessories and dimensional drawings: refer to the TERMSERIES Accessories page.	

Ordering data

Control side	24 V DC	24 V - 230 V UC	
Rated control voltage	24 V DC ±20 %	24...230 V UC ±10 %	
Nominal control current	8 mA DC (±20 %)	22 mA @ 24 V DC, 4 mA @ 230 V AC	
Power rating	≤ 200 mW	530 mW @ 24 V DC, 930 mVA @ 230 V AC	
Cut-in (switch-on) voltage	≥ 11.2 V DC	≥ 9.6 V AC, ≥ 9.6 V DC	
Dropout voltage	≤ 13 V DC	≤ 7.5 V AC, ≤ 6 V DC	
Input frequency	300 Hz	3 Hz	
Status indicator	Green LED	Green LED	
Protective circuit	Reverse polarity protection, Integrated free-wheel diode	Rectifier	
Load side			
Switch-on delay	< 50 μs	< 20 ms	
Switch-off delay	< 250 μs	< 100 ms	
Ordering data	Type	Part No.	Part No.
Screw connection 0-33 VDC/3.5A	TOS 24VDC 24VDC3.5A	1127630000	TOS 24-230VUC 24VDC3.5A 1127640000
Tension clamp connection 0-33 VDC/3.5A	TOZ 24VDC 24VDC3.5A	1127650000	TOZ 24-230VUC 24VDC3.5A 1127670000
Notes	Spare solid-state relay, Type: SSR 10-32 V DC/0-35 V DC 5 A, Part No.: 1132310000		
Ordering data	Type	Part No.	Part No.
Screw connection 12-275 VAC/1A	TOS 24VDC 230VAC1A	1127680000	TOS 24-230VUC 230VAC1A 1127690000
Tension clamp connection 12-275 VAC/1A	TOZ 24VDC 230VAC1A	1127700000	TOZ 24-230VUC 230VAC1A 1127710000
Notes	Spare solid-state relay, Type: SSR 10 - 32 VDC/12 - 275 VAC 3A, Part No.: 1132290000		

Empty socket 6.4 mm

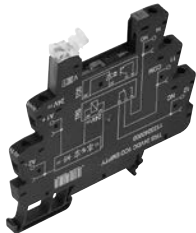
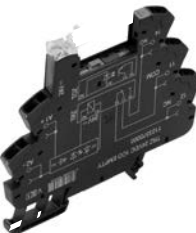
	Type / 1 CO, Screw connection	Input voltage	Qty.	Part No.
	TRS 5VDC 1CO empty	5 V DC ¹⁾	10	1123220000
	TRS 12VDC 1CO empty	12 V DC ²⁾	10	1123230000
	TRS 24VDC 1CO empty	24 V DC ³⁾	10	1123240000
	TRS 24VUC 1CO empty	24 V AC / DC ³⁾	10	1123250000
	TRS 48VUC 1CO empty	48 V AC / DC ³⁾	10	1123270000
	TRS 60VUC 1CO empty	60 V AC / DC ⁴⁾	10	1123280000
	TRS 120VUC 1CO empty	120 V AC / DC ⁴⁾	10	1123290000
	TRS 230VUC 1CO empty	230 V AC / DC ⁴⁾	10	1123300000
	TRS 120VAC RC 1CO empty	120 V AC ⁴⁾	10	1123310000
	TRS 230VAC RC 1CO empty	230 V AC ⁴⁾	10	1123320000
	TRS 24-230VUC 1CO empty	24...230 V AC / DC ³⁾	10	1123330000
	TRZ 5VDC 1CO empty	5 V DC ¹⁾	10	1123340000
	TRZ 12VDC 1CO empty	12 V DC ²⁾	10	1123350000
	TRZ 24VDC 1CO empty	24 V DC ³⁾	10	1123370000
	TRZ 24VUC 1CO empty	24 V AC / DC ³⁾	10	1123380000
	TRZ 48VUC 1CO empty	48 V AC / DC ³⁾	10	1123390000
	TRZ 60VUC 1CO empty	60 V AC / DC ⁴⁾	10	1123400000
	TRZ 120VUC 1CO empty	120 V AC / DC ⁴⁾	10	1123410000
	TRZ 230VUC 1CO empty	230 V AC / DC ⁴⁾	10	1123420000
	TRZ 120VAC RC 1CO empty	120 V AC ⁴⁾	10	1123430000
	TRZ 230VAC RC 1CO empty	230 V AC ⁴⁾	10	1123440000
	TRZ 24-230VUC 1CO empty	24...230 V AC / DC ³⁾	10	1123450000
Useable with ¹⁾ RSS...005; SSS 5V... ²⁾ RSS...012 ³⁾ RSS...024; SSS 24V... ⁴⁾ RSS...060; SSS 60V...				

Empty socket 12.8 mm

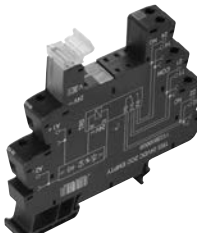
	Type / 1 CO, Screw connection	Input voltage	Qty.	Part No.	
	TOS 24VDC empty	24 V DC ¹⁾	10	1127720000	
	TOS 24-230VUC empty	24...230 V AC / DC ¹⁾	10	1127730000	
	Type / 2 CO, Screw connection				
	TRS 5VDC 2CO empty	5 V DC ²⁾	10	1123950000	
	TRS 12VDC 2CO empty	12 V DC ³⁾	10	1123970000	
	TRS 24VDC 2CO empty	24 V DC ⁴⁾	10	1123980000	
	TRS 24VUC 2CO empty	24 V AC / DC ⁴⁾	10	1123990000	
	TRS 48VUC 2CO empty	48 V AC / DC ⁵⁾	10	1124000000	
	TRS 60VUC 2CO empty	60 V AC / DC ⁶⁾	10	1124010000	
	TRS 120VUC 2CO empty	120 V AC / DC ⁷⁾	10	1124020000	
	TRS 230VUC 2CO empty	230 V AC / DC ⁷⁾	10	1124030000	
TRS 120VAC RC 2CO empty	120 V AC ⁷⁾	10	1124040000		
TRS 230VAC RC 2CO empty	230 V AC ⁷⁾	10	1124050000		
TRS 24-230VUC 2CO empty	24...230 V AC / DC ⁴⁾	10	1124070000		
Type / 1 CO, Tension clamp connection					
TOZ 24VDC empty	24 V DC ¹⁾	10	1127740000		
TOZ 24-230VUC empty	24...230 V AC / DC ¹⁾	10	1127750000		
Type / 2 CO, Tension clamp connection					
TRZ 5VDC 2CO empty	5 V DC ²⁾	10	1124080000		
TRZ 12VDC 2CO empty	12 V DC ³⁾	10	1124090000		
TRZ 24VDC 2CO empty	24 V DC ⁴⁾	10	1124100000		
TRZ 24VUC 2CO empty	24 V AC / DC ⁴⁾	10	1124110000		
TRZ 48VUC 2CO empty	48 V AC / DC ⁵⁾	10	1124120000		
TRZ 60VUC 2CO empty	60 V AC / DC ⁶⁾	10	1124130000		
TRZ 120VUC 2CO empty	120 V AC / DC ⁷⁾	10	1124140000		
TRZ 230VUC 2CO empty	230 V AC / DC ⁷⁾	10	1124150000		
TRZ 120VAC RC 2CO empty	120 V AC ⁷⁾	10	1124170000		
TRZ 230VAC RC 2CO empty	230 V AC ⁷⁾	10	1124180000		
TRZ 24-230VUC 2CO empty	24...230 V AC / DC ⁴⁾	10	1124190000		
Useable with ¹⁾ RCL31.024; SSR 10...32VDC/... ²⁾ RCL42.005 ³⁾ RCL42.012 ⁴⁾ RCL42.024 ⁵⁾ RCL42.048 ⁶⁾ RCL42.060 ⁷⁾ RCL42.110					

RSS relay module



Technical data
Type of contact / Number of contacts
Contact material
Max. switching voltage / current
Min. switching voltage / current
Min. mechanical lifetime
Min. electrical lifetime
Max. switch-on / switch-off delay
Ambient temperature (operational)
Making / Dropout voltage coil
Notes

RSS113...	RSS112...
1 CO contact	1 CO contact
AgNi	AgNi 5uAu ³⁾
250 V / 6 A ¹⁾	250 V / 6 A ¹⁾
5 V / 100 mA ²⁾	1 V / 1 mA
5 x 10 ⁶ ¹⁾	5 x 10 ⁶ ¹⁾
NO: 5 x 10 ⁴ ; NC: 3 x 10 ⁴ ¹⁾	NO: 5 x 10 ⁴ ; NC: 3 x 10 ⁴ ¹⁾
8 / 4 ms	8 / 4 ms
-40...+85 °C	-40...+85 °C
typ. 70 % / 5 % U _{NOM}	typ. 70 % / 5 % U _{NOM}
¹⁾ At resistive load ²⁾ 10 V / 10 mA; 24 V / 1 mA ³⁾ Au-plate operate up to 0.25 W	

Coil data
RSS...005
RSS...012
RSS...024
RSS...060

Nom. voltage / current
5 V DC / 34 mA
12 V DC / 14 mA
24 V DC / 7 mA
60 V DC / 3 mA

Part No.	Part No.
4061580000	1174540000
4061610000	1220670000
4060120000	4061590000
4061630000	4061600000

RCL relay module



Technical data
Type of contact / Number of contacts
Contact material
Max. switching voltage / current
Min. switching voltage / current
Min. mechanical lifetime
Min. electrical lifetime
Max. switch-on / switch-off delay
Ambient temperature (operational)
Making / Dropout voltage coil
Notes

RCL424...	RCL425...
2 CO contact	2 CO contact
AgNi	AgNi 5uAu ³⁾
250 V / 8 A ¹⁾	250 V / 8 A ¹⁾
5 V / 100 mA ²⁾	1 V / 1 mA
30 x 10 ⁶ ¹⁾	30 x 10 ⁶ ¹⁾
10 x 10 ³ ¹⁾	10 x 10 ³ ¹⁾
8 / 6 ms	8 / 6 ms
-40...+85 °C	-40...+85 °C
typ. 70 % / 10 % U _{NOM}	typ. 70 % / 10 % U _{NOM}
¹⁾ At resistive load ²⁾ 10 V / 10 mA; 24 V / 1 mA ³⁾ Au-plate operate up to 0.25 W	

Coil data
RCL...005
RCL...012
RCL...024
RCL...048
RCL...060
RCL...110

Nom. voltage / current	Nominal current
5 V DC / 80 mA	80 mA
12 V DC / 33 mA	33 mA
24 V DC / 16 mA	16 mA
48 V DC / 8 mA	8 mA
60 V DC / 6 mA	6 mA
110 V DC / 3 mA	3 mA

Part No.	Part No.
8693790000	1174490000
4058560000	4074580000
4058570000	4058580000
4058750000	1201230000
4058760000	1201260000
4058590000	8828370000

Small solid-state relay



Similar to illustration

Coil data
SSS 5 V...
SSS 24 V...
SSS 60 V...
SSS 5 V...
SSS 24 V...
SSS 60 V...
SSS 5 V...
SSS 24 V...
SSS 60 V...

Technical data
Output
Switching voltage
Continuous current
Peak reverse voltage
Forward voltage
Test voltage input / output
Ambient temperature (operational)
Storage temperature
Notes

SSS...24 V 0.1 A DC
Bipolar transistor
0...48 V DC
100 mA
54 V
< 1 V DC
2.5 kV
-20...+60 °C
-40...+70 °C

SSS...24 V 2 A DC
MOS-FET
0...24 V DC
2 A
33 V
< 120 mV
2.5 kV
-20...+60 °C
-40...+70 °C

SSS...230 V 1 A AC
Triac
24...240 V AC
1 A
600 V
< 1 V
3.75 kV
-20...+60 °C
-40...+70 °C

Nom. voltage / current
2,5...6 V DC / 4 mA
16...30 V DC / 7 mA
52...72 V DC / 3 mA
2,5...6 V DC / 9 mA
18...30 V DC / 7 mA
40...72 V DC / 3 mA
2,5...6 V DC / 15 mA
18...30 V DC / 7 mA
40...72 V DC / 3 mA

Part No.
4064320000
4061180000
4061230000
—
—
—
—
—
—

Part No.
—
—
—
4064310000
4061190000
4061200000
—
—
—
—

Part No.
—
—
—
—
—
—
1132260000
4061210000
4061220000

Solid-state relay



Similar to illustration

Coil data
SSR10...32 V DC/...

Technical data
Output
Switching voltage
Continuous current
Peak reverse voltage
Forward voltage
Test voltage input / output
Ambient temperature (operational)
Storage temperature
Notes

—
—
—
—
—
—
—
—
—

SSR.../0-35 V DC 5A
MOS-FET
0...33 V DC
1 mA...5 A
35 V
< 300 mV
2.5 kV
-20...+80 °C
-40...+100 °C

SSR.../12-275 V AC 3A
TRIAC, zero cross switch
12...275 V AC
50 mA...3 A
600 V
< 1.1 V
2.5 kV
-20...+80 °C
-40...+100 °C

Nom. voltage / current
10...32 V/3...13 mA

Part No.
1132310000

Part No.
1132290000

Plug-in cross-connection

	Type	Number of poles / Pitch	Qty.	Part No.
	ZQV 1.5N/R6.4/2 GE	2 / 6.4	10	1193670000
	ZQV 1.5N/R6.4/10 GE	10 / 6.4	10	1193680000
	ZQV 1.5N/R6.4/19 GE	19 / 6.4	10	1193690000
	ZQV 1.5N/R12.8/10 GE	10 / 12.8	10	1193700000

Supply terminal

	Type	Connection technology	Qty.	Part No.
	TXS SUPPLY	Screw connection	10	1240780000
	TXZ SUPPLY	Tension clamp connection	10	1240790000

Other accessories

	Type / Isolation plate		Qty.	Part No.
	TW TXS/TXZ R3.2	Isolation plate 3.2 mm pitch	10	1240800000
	Markers			
	WS 10/6 MC Middle	10 x 6 mm	600	1818400000
	Screwdriver			
	SDK PH0	only screw connection	1	9008470000
	SD 0.6 x 3.5 x 100		1	9008330000
	SD TO 0.6 X 3.0	only tension clamp connection	1	1323880000
	End bracket			
	WEW35/2 SW		100	1061210000

Technical data

Conductor		Screw connection		Tension clamp connection	
1 conductor					
Solid H07V-U	mm ²	0.14...2.5		0.14... 1.5	
Stranded H07V-K	mm ²	0.14... 1.5		0.14... 1.5	
... with wire end ferrule	mm ²	0.25... 1.5		0.14... 1.5	
... with wire end ferrule with plastic collar	mm ²	0.25... 1.5		0.14... 1.5	
2 conductor with same size					
Solid H07V-U	mm ²	0.5... 1.0		0.5... 1.0	
Stranded H07V-K	mm ²	0.5... 1.0		0.5... 1.0	
... with twin wire end ferrule H...D ZH	mm ²	0.5... 1.5		0.5... 1.0	
Clamping range AWG.../1	AWG	26... 14		26... 16	
Clamping range AWG.../7	AWG	26... 16		26... 16	
Clamping range AWG.../19	AWG	26... 16		26... 16	
Plug gauge to IEC 60947-1	Size	A1 / B1		A1 / B1	
General data					
Nominal torque	Nm	0.4			
Stripping length	mm	8		8	
Continuous current ZQV 1.5N/R6.4	A	UL: 10		UL: 10	
No. Contact durability relay / ZQV		10		10	
Notes					

Dimensions

