

## Digital Temperature Controllers

### Communications Manual

E5□C

- 1 Communications Methods
- 2 CompoWay/F Communications Procedures
- 3 Communications Data for CompoWay/F
- 4 Modbus Communications Procedure
- 5 Communications Data for Modbus
- 6 Programless Communications
- 7 Component Communications
- A Appendices
- I Index





# Preface

---

This Communications Manual describes the communications capabilities supported by the E5□C Digital Controllers.

Read and understand this manual before using communications with the E5□C Digital Controllers and be sure you are performing communications correctly.

Keep this manual in a safe location where it will be available when needed.

**© OMRON, 2011**

All rights reserved. No part of this publication may be reproduced, stored in a retrieval system or transmitted, in any form, or by any means, mechanical, electronic, photocopying, recording, or otherwise, without the prior written permission of OMRON.

No patent liability is assumed with respect to the use of the information contained herein. Moreover, because OMRON is constantly striving to improve its high-quality products, the information contained in this manual is subject to change without notice. Every precaution has been taken in the preparation of this manual. Nevertheless, OMRON assumes no responsibility for errors or omissions. Neither is any liability assumed for damages resulting from the use of the information contained in this publication.

# Terms and Conditions Agreement

---

## Warranty, Limitations of Liability

### Warranties

---

- **Exclusive Warranty**

Omron's exclusive warranty is that the Products will be free from defects in materials and workmanship for a period of twelve months from the date of sale by Omron (or such other period expressed in writing by Omron). Omron disclaims all other warranties, express or implied.

- **Limitations**

OMRON MAKES NO WARRANTY OR REPRESENTATION, EXPRESS OR IMPLIED, ABOUT NON-INFRINGEMENT, MERCHANTABILITY OR FITNESS FOR A PARTICULAR PURPOSE OF THE PRODUCTS. BUYER ACKNOWLEDGES THAT IT ALONE HAS DETERMINED THAT THE PRODUCTS WILL SUITABLY MEET THE REQUIREMENTS OF THEIR INTENDED USE.

Omron further disclaims all warranties and responsibility of any type for claims or expenses based on infringement by the Products or otherwise of any intellectual property right.

- **Buyer Remedy**

Omron's sole obligation hereunder shall be, at Omron's election, to (i) replace (in the form originally shipped with Buyer responsible for labor charges for removal or replacement thereof) the non-complying Product, (ii) repair the non-complying Product, or (iii) repay or credit Buyer an amount equal to the purchase price of the non-complying Product; provided that in no event shall Omron be responsible for warranty, repair, indemnity or any other claims or expenses regarding the Products unless Omron's analysis confirms that the Products were properly handled, stored, installed and maintained and not subject to contamination, abuse, misuse or inappropriate modification. Return of any Products by Buyer must be approved in writing by Omron before shipment. Omron Companies shall not be liable for the suitability or unsuitability or the results from the use of Products in combination with any electrical or electronic components, circuits, system assemblies or any other materials or substances or environments. Any advice, recommendations or information given orally or in writing, are not to be construed as an amendment or addition to the above warranty.

See <http://www.omron.com/global/> or contact your Omron representative for published information.

### Limitation on Liability; Etc

---

OMRON COMPANIES SHALL NOT BE LIABLE FOR SPECIAL, INDIRECT, INCIDENTAL, OR CONSEQUENTIAL DAMAGES, LOSS OF PROFITS OR PRODUCTION OR COMMERCIAL LOSS IN ANY WAY CONNECTED WITH THE PRODUCTS, WHETHER SUCH CLAIM IS BASED IN CONTRACT, WARRANTY, NEGLIGENCE OR STRICT LIABILITY.

Further, in no event shall liability of Omron Companies exceed the individual price of the Product on which liability is asserted.

## Application Considerations

### Suitability of Use

---

Omron Companies shall not be responsible for conformity with any standards, codes or regulations which apply to the combination of the Product in the Buyer's application or use of the Product. At Buyer's request, Omron will provide applicable third party certification documents identifying ratings and limitations of use which apply to the Product. This information by itself is not sufficient for a complete determination of the suitability of the Product in combination with the end product, machine, system, or other application or use. Buyer shall be solely responsible for determining appropriateness of the particular Product with respect to Buyer's application, product or system. Buyer shall take application responsibility in all cases.

NEVER USE THE PRODUCT FOR AN APPLICATION INVOLVING SERIOUS RISK TO LIFE OR PROPERTY WITHOUT ENSURING THAT THE SYSTEM AS A WHOLE HAS BEEN DESIGNED TO ADDRESS THE RISKS, AND THAT THE OMRON PRODUCT(S) IS PROPERLY RATED AND INSTALLED FOR THE INTENDED USE WITHIN THE OVERALL EQUIPMENT OR SYSTEM.

### Programmable Products

---

Omron Companies shall not be responsible for the user's programming of a programmable Product, or any consequence thereof.

## Disclaimers

### Performance Data

---

Data presented in Omron Company websites, catalogs and other materials is provided as a guide for the user in determining suitability and does not constitute a warranty. It may represent the result of Omron's test conditions, and the user must correlate it to actual application requirements. Actual performance is subject to the Omron's Warranty and Limitations of Liability.

### Change in Specifications

---

Product specifications and accessories may be changed at any time based on improvements and other reasons. It is our practice to change part numbers when published ratings or features are changed, or when significant construction changes are made. However, some specifications of the Product may be changed without any notice. When in doubt, special part numbers may be assigned to fix or establish key specifications for your application. Please consult with your Omron's representative at any time to confirm actual specifications of purchased Product.

### Errors and Omissions

---

Information presented by Omron Companies has been checked and is believed to be accurate; however, no responsibility is assumed for clerical, typographical or proofreading errors or omissions.

# Safety Precautions

## Definition of Precautionary Information





The following notation is used in this manual to provide precautions required to ensure safe usage of the E5□C Digital Controllers.

The safety precautions that are provided are extremely important to safety. Always read and heed the information provided in all safety precautions.

The following notation is used.

 <b>CAUTION</b>	Indicates a potentially hazardous situation which, if not avoided, may result in minor or moderate injury or in property damage.
--	--

## Symbols

Symbol	Meaning	
<b>Caution</b>		<ul style="list-style-type: none"> <li>• General Caution Indicates non-specific general cautions, warnings, and dangers.</li> </ul>
		<ul style="list-style-type: none"> <li>• Electrical Shock Caution Indicates possibility of electric shock under specific conditions.</li> </ul>
<b>Prohibition</b>		<ul style="list-style-type: none"> <li>• General Prohibition Indicates non-specific general prohibitions.</li> </ul>
		<ul style="list-style-type: none"> <li>• Disassembly Prohibition Indicates prohibitions when there is a possibility of injury, such as from electric shock, as the result of disassembly.</li> </ul>
<b>Mandatory Caution</b>		<ul style="list-style-type: none"> <li>• General Caution Indicates non-specific general cautions, warnings, and dangers.</li> </ul>

## ● Safety Precautions

### CAUTION

Minor injury due to electric shock may occasionally occur.  
Do not touch the terminals while power is being supplied.



Electric shock, fire, or malfunction may occasionally occur.  
Do not allow metal objects, conductors, cuttings from installation work, or moisture to enter the Digital Controller or a Setup Tool port. Attach the cover to the front-panel Setup Tool port whenever you are not using it to prevent foreign objects from entering the port.



Minor injury from explosion may occasionally occur.  
Do not use the product where subject to flammable or explosive gas.



Fire may occasionally occur.  
Do not allow dirt or other foreign objects to enter a Setup Tool port, or between the pins on the connectors on the Setup Tool cable.



Minor electric shock, fire, or malfunction may occasionally occur.  
Never disassemble, modify, or repair the product or touch any of the internal parts.



#### CAUTION - Risk of Fire and Electric Shock

- (a) This product is UL listed as Open Type Process Control Equipment. It must be mounted in an enclosure that does not allow fire to escape externally.
- (b) More than one disconnect switch may be required to de-energize the equipment before servicing.
- (c) Signal inputs are SELV, limited energy.\*<sup>1</sup>
- (d) Caution: To reduce the risk of fire or electric shock, do not interconnect the outputs of different Class 2 circuits.\*<sup>2</sup>



If the output relays are used past their life expectancy, contact fusing or burning may occasionally occur.  
Always consider the application conditions and use the output relays within their rated load and electrical life expectancy. The life expectancy of output relays varies considerably with the output load and switching conditions.



\*1 An SELV (separated extra-low voltage) system is one with a power supply that has double or reinforced insulation between the primary and the secondary circuits and has an output voltage of 30 V r.m.s. max. and 42.4 V peak max. or 60 VDC max.

\*2 A class 2 circuit is one tested and certified by UL as having the current and voltage of the secondary output restricted to specific levels.

 **CAUTION**

If you replace only the Main Unit of the E5DC, check the condition of the Terminal Unit.

If corroded terminals are used, contact failure in the terminals may cause the temperature inside the Digital Controller to increase, possibly resulting in fire.

If the terminals are corroded, replace the Terminal Unit as well.



Loose screws may occasionally result in fire.

Tighten the terminal screws to the specified torque of 0.43 to 0.58 N·m.\*



Set the parameters of the product so that they are suitable for the system being controlled. If they are not suitable, unexpected operation may occasionally result in property damage or accidents.



A malfunction in the Digital Controller may occasionally make control operations impossible or prevent alarm outputs, resulting in property damage. To maintain safety in the event of malfunction of the Digital Controller, take appropriate safety measures, such as installing a monitoring device on a separate line.



\* The specified torque is 0.5 N·m for the E5CC-U.



# Precautions for Safe Use

Be sure to observe the following precautions to prevent operation failure, malfunction, or adverse affects on the performance and functions of the product. Not doing so may occasionally result in unexpected events. Use the product within specifications.

- This product is designed for indoor use only. Do not use or store the Digital Temperature Controller in any of the following places.

Places directly subject to heat radiated from heating equipment.

Places subject to splashing liquid or oil atmosphere.

Places subject to direct sunlight.

Places subject to dust or corrosive gas (in particular, sulfide gas and ammonia gas).

Places subject to intense temperature change.

Places subject to icing and condensation.

Places subject to vibration and large shocks.

- Use and store the Digital Controller within the rated ambient temperature and humidity. Gang-mounting two or more Digital Controllers, or mounting Digital Controllers above each other may cause heat to build up inside the Digital Controllers, which will shorten their service life. In such a case, use forced cooling by fans or other means of air ventilation to cool down the Digital Controllers.
- To allow heat to escape, do not block the area around the product. Do not block the ventilation holes on the product.
- Be sure to wire properly with the correct signal name and polarity of terminals.
- Use the specified size of crimped terminals (M3, width of 5.8 mm or less) to wire the E5CC, E5EC, E5AC, or E5DC.

To connect bare wires to the terminal block of the E5CC, E5EC, E5AC, or E5DC, use copper braided or solid wires with a gauge of AWG24 to AWG18 (equal to a cross-sectional area of 0.205 to 0.823 mm<sup>2</sup>). (The stripping length is 6 to 8 mm.) Up to two wires of the same size and type, or two crimped terminals can be inserted into a single terminal.

Use the specified size of crimped terminals (M3, width of 5.8 mm or less) to wire the E5GC.\*

To connect bare wires to the terminal block of the E5GC, use copper braided or solid wires with a gauge of AWG24 to AWG18 (equal to a cross-sectional area of 0.205 to 0.823 mm<sup>2</sup>). (The stripping length for Digital Temperature Controllers with screw terminal blocks is 6 to 8 mm. The stripping length for Digital Temperature Controllers with screwless clamp terminal blocks is 8 to 12 mm.)

Up to two wires of the same size and type, or two crimped terminals can be inserted into a single terminal. When connecting two wires into one terminal of a Digital Temperature Controller with a screwless clamp terminal block, use ferrules with a diameter of 0.8 to 1.4 mm and an exposed conductor length of 8 to 12 mm that two wires are crimped for a ferrule.\*

\* The Digital Temperature Controller with screwless clamp terminals underwent UL testing with one braided wire connected.

- Do not wire the terminals that are not used.
- To avoid inductive noise, keep the wiring for the Digital Controller's terminal block away from power cables that carry high voltages or large currents. Also, do not wire power lines together with or parallel to Digital Controller wiring. Using shielded cables and using separate conduits or ducts are recommended.

Attach a surge suppressor or noise filter to peripheral devices that generate noise (in particular, motors, transformers, solenoids, magnetic coils or other equipment that have an inductance component).

When a noise filter is used at the power supply, first check the voltage or current, and attach the noise filter as close as possible to the Digital Controller.

Allow as much space as possible between the Digital Controller and devices that generate powerful high frequencies (high-frequency welders, high-frequency sewing machines, etc.) or surge.

- Use the Digital Temperature Controller within the rated load and power supply.
- Make sure that the rated voltage is attained within 2 seconds of turning ON the power using a switch or relay contact. If the voltage is applied gradually, the power may not be reset or output malfunctions may occur.
- Make sure that the Digital Controller has 30 minutes or more to warm up after turning ON the power before starting actual control operations to ensure the correct temperature display.
- When executing self-tuning, turn ON power for the load (e.g., heater) at the same time as or before supplying power to the Digital Controller. If power is turned ON for the Digital Controller before turning ON power for the load, self-tuning will not be performed properly and optimum control will not be achieved.
- A switch or circuit breaker must be provided close to the Digital Controller. The switch or circuit breaker must be within easy reach of the operator, and must be marked as a disconnecting means for the Digital Controller.
- Wipe off any dirt from the Digital Controller with a soft dry cloth. Never use thinners, benzene, alcohol, or any cleaners that contain these or other organic solvents. Deformation or discoloration may occur.
- Design the system (e.g., control panel) considering the 2 seconds of delay in setting the Digital Controller's output after the power supply is turned ON.
- The output will turn OFF when you move to the initial setting level. Take this into consideration when performing control.
- The number of non-volatile memory write operations is limited. Therefore, use RAM write mode when frequently overwriting data, e.g., through communications.
- Use suitable tools when taking the Digital Controller apart for disposal. Sharp parts inside the Digital Controller may cause injury.
- Always touch a grounded piece of metal before touching the Digital Temperature Controller to discharge static electricity from your body.
- For compliance with Lloyd's standards, the E5CC, E5CC-U, E5EC, or E5AC must be installed under the conditions that are specified in Shipping Standards in the *E5□C Digital Temperature Controller User's Manual* (Cat. No. H174).
- For the Digital Temperature Controller with two Setup Tool ports (E5EC/E5AC/E5DC/E5GC), do not connect cables to both ports at the same time.  
The Digital Temperature Controller may be damaged or may malfunction.
- Do not exceed the communications distance that is given in the specifications and use the specified communications cable. Refer to the *E5□C Digital Temperature Controllers User's Manual* (Cat. No. H174) for the communications distance and cable specifications.
- Do not turn the power supply to the Digital Controller ON or OFF while the USB-Serial Conversion Cable is connected. The Digital Controller may malfunction.
- Do not bend the communications cables past their natural bending radius. Do not pull on the communications cables.
- For the E5DC, when you attach the Main Unit to the Terminal Unit, make sure that the hooks on the Main Unit are securely inserted into the Terminal Unit.
- Install the DIN Track vertically to the ground.
- For the E5DC, always turn OFF the power supply before connecting the Main Unit to or disconnecting the Main Unit from the Terminal Unit, and never touch nor apply shock to the terminals or electronic components. When connecting or disconnecting the Main Unit, do not allow the electronic components to touch the case.
- Observe the following precautions when you remove the terminal block or pulling out (draw out) the interior of the E5GC.
  - Always follow the instructions provided in the *E5□C Digital Controllers User's Manual* (Cat. No. H174).

- Turn OFF the power supply before you start and never touch nor apply shock to the terminals or electric components.  
When you insert the interior body of the Digital Controller, do not allow the electronic components to touch the case.
- Check for any corrosion on the terminals.
- When you insert the interior body into the rear case, confirm that the hooks on the top and bottom are securely engaged with the case.

# Trademarks

---

- MELSEC and GX-Works are trademarks of the Mitsubishi Electric Corporation.
- Keyence KV STUDIO is a registered trademark of Keyence Corporation.

Other company names and product names in this document are the trademarks or registered trademarks of their respective companies.

# Versions

Check the version on the nameplate on the E5□C Controller or on the label on the packing box. If the version is not given, the version of the E5□C Controller is version 1.0.

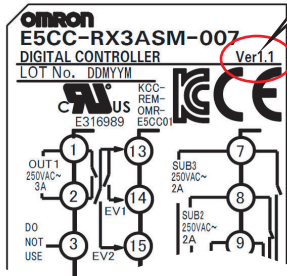
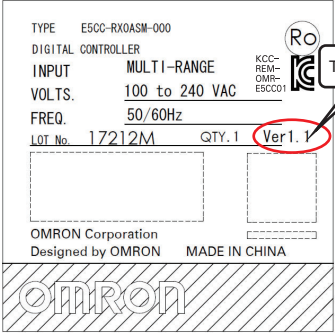
Product nameplate	Package label
 <p>The version is given here.</p>	 <p>The version is given here.</p>

# Revision History

A manual revision code appears as a suffix to the catalog number on the front cover of the manual.

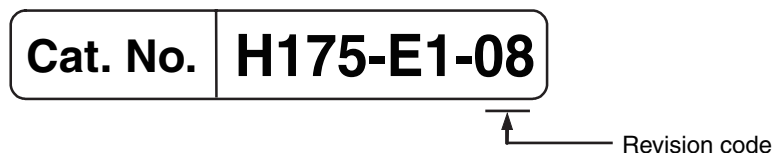

Revision code	Date	Revised content
01	December 2011	Original production
02	January 2012	<b>Page 9:</b> Made correction in <i>Precautions for Safe Use</i> .
03	May 2012	Added the following sections: <i>Section 6 Programless Communications</i> and <i>Section 7 Component Communications</i> . <b>Page 10:</b> Added trademark information. <b>Page 11:</b> Added version information. <b>Page 13:</b> Added functional upgrade information. <b>Pages 3-17 to 3-18:</b> CompoWay/F variable area additions. Corrected mistakes.
04	December 2012	Added Digital Controllers with position-proportional control.
05	March 2013	<b>Page 13:</b> Corrected maximum number of Controllers in four locations and corrected last line. <b>Page 6-3:</b> Corrected maximum number of Controllers in two locations and corrected total number of words in middle of page. <b>Pages 6-7, 6-13, and 6-14:</b> Corrected maximum number of Controllers in table. <b>Page 7-2:</b> Corrected maximum number of Controllers in figure.
06	July 2013	Added E5DC Digital Controllers. <b>Page 6:</b> Changed notes and changed caution mark. <b>Pages 7 and 9:</b> Added precautions. <b>Page 11:</b> Change figures. <b>Pages 13, 15, 6-1, and 7-1:</b> Removed version indication. <b>Page 13:</b> Changed sentence at bottom of page. <b>Page 1-4:</b> Changed model designations and added figure. <b>Pages 3-15 and 5-8:</b> Added "linear" in two places on each page. <b>Pages 3-20 and 5-14:</b> Added LCT Cooling Output Minimum ON Time. <b>Pages 6-1 and 7-1:</b> Added version information. <b>Page 7-2:</b> Changed model information and figure at bottom of page.
07	December 2013	Added Mitsubishi's FX Series and Keyence's KV Series to programless communications. Corrected mistakes.
08	April 2014	Made revisions accompanying addition of the E5GC. Corrected mistakes.

# Sections in This Manual

## How This Manual is Organized

Descriptions in this manual are separated by the communications method.  
Read the sections that are applicable to the system being used.

		1
1	Communications Methods	2
2	CompoWay/F Communications Procedures	3
3	Communications Data for CompoWay/F	4
4	Modbus Communications Procedure	5
5	Communications Data for Modbus	6
6	Programless Communications	7
7	Component Communications	A
A	Appendices	I
I	Index	

## Related Manuals

For details on the functions of the E5□C Digital Controllers, refer to the *E5□C Digital Temperature Controllers User's Manual* (Cat. No. H174).

# CONTENTS

---

<b>Preface .....</b>	<b>1</b>
<b>Terms and Conditions Agreement.....</b>	<b>2</b>
Warranty, Limitations of Liability .....	2
Application Considerations .....	3
Disclaimers .....	3
<b>Safety Precautions .....</b>	<b>4</b>
Definition of Precautionary Information .....	4
Symbols .....	4
<b>Precautions for Safe Use .....</b>	<b>7</b>
<b>Trademarks .....</b>	<b>10</b>
<b>Versions .....</b>	<b>11</b>
<b>Revision History .....</b>	<b>12</b>
<b>Sections in This Manual .....</b>	<b>13</b>
How This Manual is Organized .....	13
Related Manuals .....	13

## Section 1      **Communications Methods**

---

<b>1-1 Overview of Communications Methods .....</b>	<b>1-2</b>
1-1-1 Introduction .....	1-2
1-1-2 Communications Specifications .....	1-2
1-1-3 Transmission Procedure.....	1-3
1-1-4 Interface .....	1-3
1-1-5 Wiring.....	1-4
1-1-6 Communications Parameters .....	1-6
1-1-7 Communications Parameter Setup .....	1-7
1-1-8 Description of Communications Parameters .....	1-8

## Section 2      **CompoWay/F Communications Procedures**

---

<b>2-1 Data Format.....</b>	<b>2-2</b>
2-1-1 Command Frame .....	2-2
2-1-2 BCC Calculation Example.....	2-3
2-1-3 Response Frame.....	2-3
2-1-4 Communications Data.....	2-4
2-1-5 End Code Example .....	2-4
<b>2-2 Structure of Command Text.....</b>	<b>2-6</b>
2-2-1 PDU Structure.....	2-6
2-2-2 Area Definitions.....	2-6
2-2-3 Type Code (Variable Type) .....	2-6
2-2-4 Addresses .....	2-7
2-2-5 Number of Elements .....	2-7
2-2-6 List of Services (Main Request Codes and Sub-Request Codes) .....	2-7
<b>2-3 Detailed Description of the Services .....</b>	<b>2-8</b>
2-3-1 Read Variable Area .....	2-8
2-3-2 Write Variable Area .....	2-9
2-3-3 Composite Read from Variable Area.....	2-10



2-3-4	Composite Write to Variable Area.....	2-12
2-3-5	Read Controller Attributes .....	2-13
2-3-6	Read Controller Status .....	2-14
2-3-7	Echoback Test .....	2-15
2-3-8	Operation Command .....	2-16
<b>2-4</b>	<b>Response Code List .....</b>	<b>2-21</b>

## Section 3 Communications Data for CompoWay/F

---

<b>3-1</b>	<b>Variable Area (Setting Range) List.....</b>	<b>3-2</b>
<b>3-2</b>	<b>Status and Status 2 .....</b>	<b>3-22</b>

## Section 4 Modbus Communications Procedure

---

<b>4-1</b>	<b>Data Format.....</b>	<b>4-2</b>
4-1-1	Command Frame .....	4-2
4-1-2	Response Frame .....	4-4
4-1-3	Error Codes .....	4-5
<b>4-2</b>	<b>Function List .....</b>	<b>4-6</b>
<b>4-3</b>	<b>Variable Area.....</b>	<b>4-7</b>
<b>4-4</b>	<b>Detailed Description of the Functions.....</b>	<b>4-8</b>
4-4-1	Variable Read, Multiple .....	4-8
4-4-2	Variable Write, Multiple .....	4-10
4-4-3	Variable Write, Single/Operation Command .....	4-12
4-4-4	Echoback Test .....	4-15

## Section 5 Communications Data for Modbus

---

<b>5-1</b>	<b>Variable Area (Setting Range) List.....</b>	<b>5-2</b>
<b>5-2</b>	<b>Status.....</b>	<b>5-17</b>

## Section 6 Programless Communications

---

<b>6-1</b>	<b>Programless Communications.....</b>	<b>6-3</b>
6-1-1	Introduction.....	6-3
6-1-2	Features.....	6-3
6-1-3	Operation for Programless Communications .....	6-4
6-1-4	Timing of Turning Power ON and OFF.....	6-4
6-1-5	Connectable PLCs.....	6-5
<b>6-2</b>	<b>E5□C Setup.....</b>	<b>6-6</b>
6-2-1	Protocol Setting .....	6-6
6-2-2	Communications Unit No. and Communications Baud Rate .....	6-7
6-2-3	Send Data Wait Time.....	6-7
6-2-4	Highest Communications Unit No. ....	6-7
6-2-5	Areas and First Address of Linked Data .....	6-8
6-2-6	Receive Data Wait Time .....	6-10
6-2-7	Communications Node Number.....	6-10
6-2-8	Upload Settings and Download Settings .....	6-11
6-2-9	Copying Parameter Settings .....	6-13
6-2-10	Communications Writing.....	6-15
6-2-11	Communications Monitor Parameter .....	6-16
<b>6-3</b>	<b>Controlling Programless Communications.....</b>	<b>6-17</b>
6-3-1	Controlling Programless Communications with the Request Flag.....	6-17
6-3-2	Response Flag.....	6-18

6-3-3	Range of Operation for Programless Communications .....	6-19
6-3-4	Operation Command Codes .....	6-19
6-3-5	Confirming Operation of Programless Communications .....	6-19
6-3-6	Write Mode.....	6-20
6-3-7	Troubleshooting.....	6-20
<b>6-4</b>	<b>Connecting to CP-series PLCs.....</b>	<b>6-21</b>
6-4-1	Configuration and Procedure .....	6-21
6-4-2	Switch Settings and Wiring .....	6-22
6-4-3	PLC Setup.....	6-22
6-4-4	E5□C Controller Setup .....	6-25
6-4-5	Checking Operation .....	6-27
<b>6-5</b>	<b>Connecting to CJ-series PLCs .....</b>	<b>6-32</b>
6-5-1	Configuration and Procedure .....	6-32
6-5-2	Switch Settings and Wiring .....	6-33
6-5-3	PLC Setup.....	6-33
6-5-4	E5□C Controller Setup .....	6-36
6-5-5	Checking Operation .....	6-36
<b>6-6</b>	<b>Connecting to MELSEC Q-series PLCs .....</b>	<b>6-37</b>
6-6-1	Configuration and Procedure .....	6-37
6-6-2	Wiring.....	6-38
6-6-3	PLC Setup.....	6-38
6-6-4	E5□C Controller Setup .....	6-43
6-6-5	Checking Operation .....	6-44
<b>6-7</b>	<b>Connecting to MELSEC-FX-series PLCs .....</b>	<b>6-49</b>
6-7-1	Configuration and Procedure .....	6-49
6-7-2	Wiring.....	6-50
6-7-3	PLC Setup.....	6-50
6-7-4	E5□C Controller Setup .....	6-55
6-7-5	Checking Operation .....	6-55
<b>6-8</b>	<b>Connecting to Keyence KV-series PLCs .....</b>	<b>6-56</b>
6-8-1	Configuration and Procedure .....	6-56
6-8-2	Wiring.....	6-57
6-8-3	PLC Setup.....	6-57
6-8-4	E5□C Controller Setup .....	6-58
6-8-5	Checking Operation .....	6-58

## Section 7 Component Communications

---

<b>7-1</b>	<b>Component Communications.....</b>	<b>7-2</b>
7-1-1	Introduction .....	7-2
7-1-2	Wiring.....	7-2
7-1-3	E5□C Setup.....	7-3
<b>7-2</b>	<b>Operation for Component Communications.....</b>	<b>7-5</b>
<b>7-3</b>	<b>Troubleshooting.....</b>	<b>7-6</b>

## Section A Appendices

---

<b>A-1</b>	<b>ASCII List.....</b>	<b>A-2</b>
<b>A-2</b>	<b>Troubleshooting.....</b>	<b>A-3</b>

## Index

---



# 1

## Communications Methods

---

This section briefly describes the supported communications methods and how to wire equipment. Refer to this section when setting up equipment.

---

<b>1-1</b>	<b>Overview of Communications Methods</b>	<b>1-2</b>
1-1-1	Introduction	1-2
1-1-2	Communications Specifications	1-2
1-1-3	Transmission Procedure	1-3
1-1-4	Interface	1-3
1-1-5	Wiring	1-4
1-1-6	Communications Parameters	1-6
1-1-7	Communications Parameter Setup	1-7
1-1-8	Description of Communications Parameters	1-8

# 1-1 Overview of Communications Methods

## 1-1-1 Introduction

The program for the communications functions is created on the host (personal computer, PLC, or other type of communications master), and the E5□C's parameters are monitored or set from the host. Therefore, the description provided here is from the viewpoint of the host.

CompoWay/F is OMRON's standard communications format for general serial communications. This format uses a standard frame format as well as the well-established FINS\* commands used for OMRON's PLCs. Therefore, it can simplify communications between components and the host.

\* FINS (Factory Interface Network service)

The FINS protocol provides message communications between controllers in OMRON FA networks.

Modbus is a standard communications control method that conforms to the Modicon Company's RTU-mode Modbus Protocol (PI-MBUS-300 Revision J). Modbus is a registered trademark of Schneider Electric.

It supports functions equivalent to the CompoWay/F Read Variable Area, Write Variable Area, Operation Command, and Echoback Test functions.

The E5□C supports the following communications functions.

- Reading/writing of parameters
- Operation instructions
- Selection of setup levels

Communications are subject to the following condition:

- Parameters can be written only when the Communications Writing parameter is set to ON (enabled).

## 1-1-2 Communications Specifications

<b>Transmission line connection</b>	RS-485: Multidrop
<b>Communications method</b>	RS-485 (2-wire, half-duplex)
<b>Synchronization method</b>	Start-stop synchronization
<b>Communications baud rate *</b>	9,600, 19,200, 38,400 or 57,600 bps
<b>Communications code</b>	ASCII
<b>Communications data length *</b>	7 or 8 bits
<b>Communications stop bits *</b>	1 or 2 bits
<b>Error detection</b>	Vertical parity (none, even, or odd) * BCC (Block Check Character) with CompoWay/F communications CRC-16 (Cyclic Redundancy Check 16) with Modbus communications
<b>Flow control</b>	None
<b>Interface</b>	RS-485
<b>Retry function</b>	None
<b>Communications buffer</b>	217 bytes
<b>Send data wait time</b>	0 to 99 ms, default time: 20 ms

\* Communications baud rate, data length, stop bits and vertical parity can each be set independently in the communications setting level. Highlighted values indicate default settings.

### 1-1-3 Transmission Procedure

When the host transmits a command frame, the E5□C transmits a response frame that corresponds to the command frame. A single response frame is returned for each command frame. The following diagram shows the operation of the command and response frames.

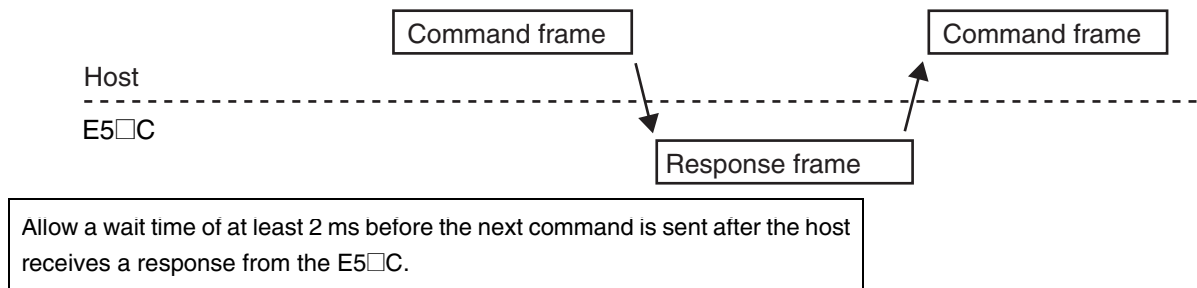

### 1-1-4 Interface

Communications with the host are carried out through a standard RS-485 interface. Use a K3SC Interface Converter for RS-485 interface conversion.

### 1-1-5 Wiring

● **RS-485**

- The RS-485 connection can be either one-to-one or one-to-N. Up to 32 units including the host can be connected in a one-to-N system.
- The total cable length is 500 m max.
- Use a shielded twisted-pair cable with a wire gauge of AWG24 to AWG18 (cross-sectional area of 0.205 to 0.823 mm<sup>2</sup>).

**E5CC/EC/AC**

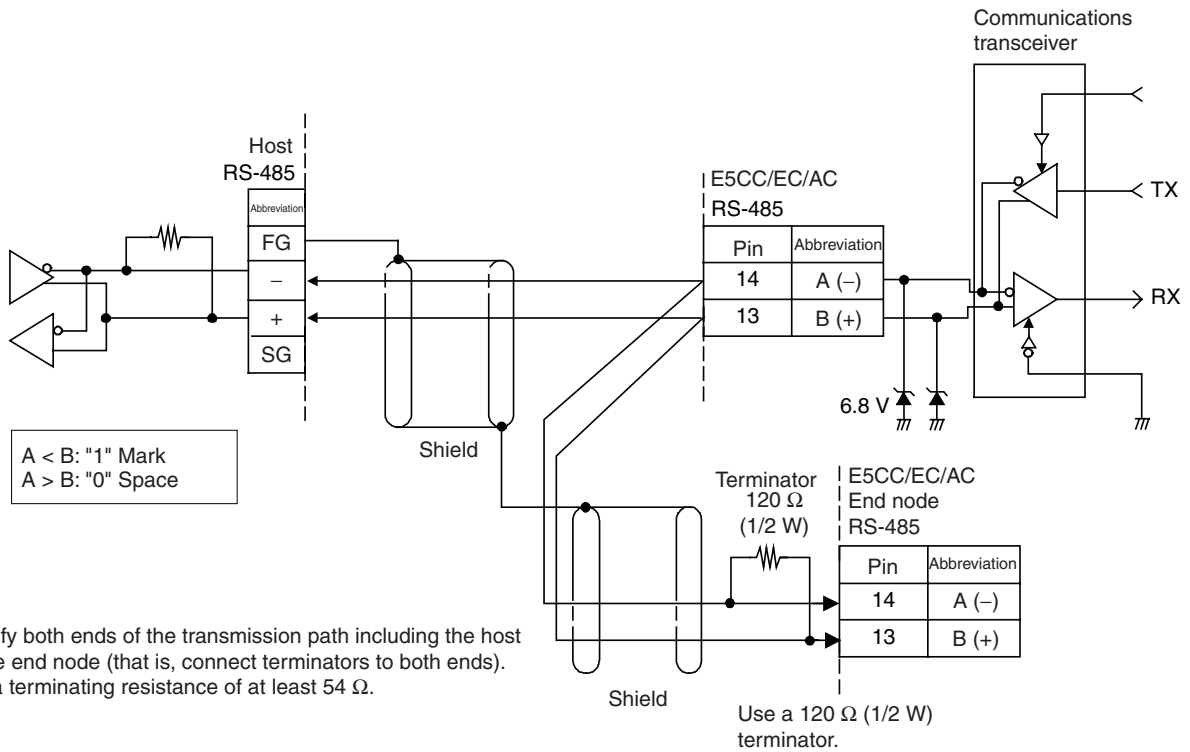

### E5DC

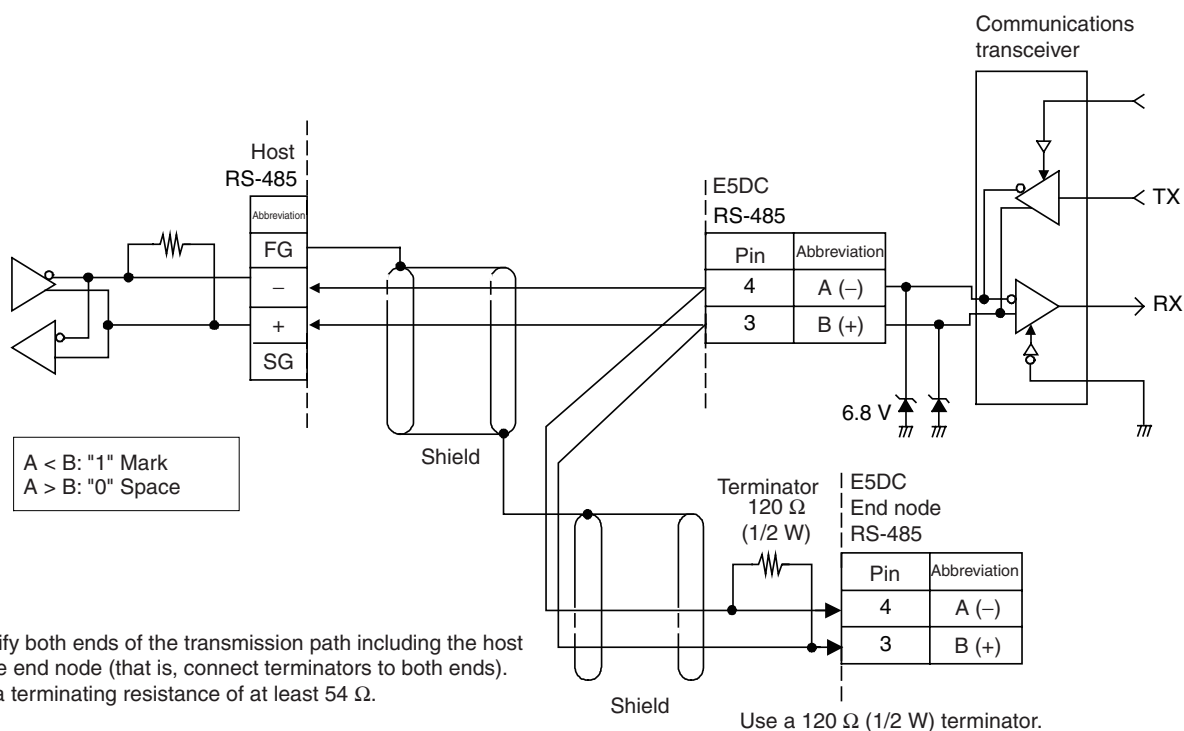

### E5GC

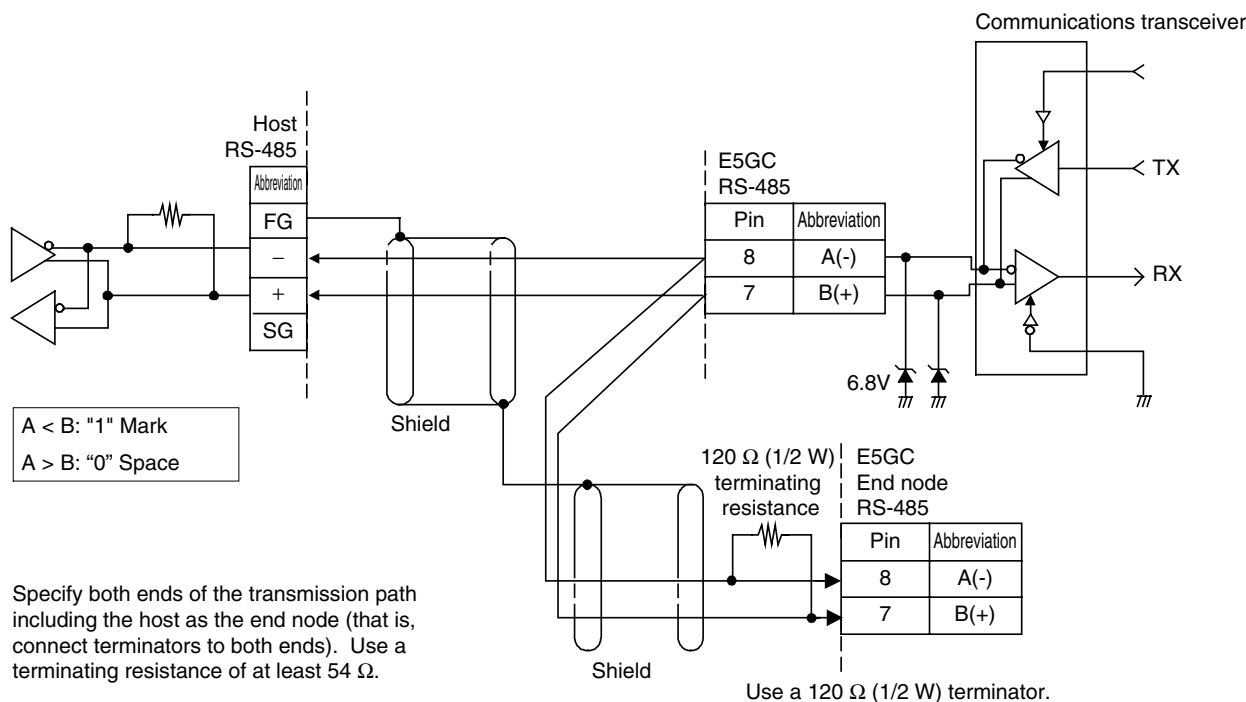

Match the communications specifications of the E5□C and the host. When using a 1:N connection, set the same communications specifications in all of the Units. Each Communications Unit must have a unique unit number.

This section explains how to set the E5□C's communications specifications. For details on the host, refer to the user's manual provided with the host.

## 1-1-6 Communications Parameters

The E5□C's communications specifications are set in the communications setting level. These parameters are set on the E5□C's front panel. The following table shows the communications parameters and their setting ranges.

Item	Code	Settings	Set Values
Communications protocol setting	<i>PSEL</i>	CompoWay/F /Modbus	<i>CWF/Mod</i>
Communications unit number	<i>U-Nō</i>	0 to 99	0, <b>1</b> to 99
Communications baud rate	<i>bPS</i>	9.6/19.2/38.4/57.6 (kbit/s)	<b>9.6</b> /19.2 /38.4/57.6 (kbit/s)
Communications data length *	<i>LEN</i>	7/8 (bit)	<b>7</b> /8 (bit)
Communications stop bits *	<i>Sbct</i>	1/2	<b>1</b> /2
Communications parity	<i>PRTY</i>	None, Even, Odd	<i>NōNE/EVEN/ōdd</i>
Send data wait time	<i>sdwt</i>	0 to 99	0 to 99 ms, default time: <b>20</b> ms





Highlighted values indicate default settings.

- \* When the Protocol Setting parameter is set to Modbus, the communications data length must be 8 bits, and the communications stop bits must be 1 bit by setting the communications parity to Even/Odd or it must be 2 bits by setting the parity to None. These two parameters are not displayed on the Controller's display.



### 1-1-7 Communications Parameter Setup

Before you carry out communications with the E5□C, set up the communications unit number, baud rate, and other parameters by carrying out the following procedure. For details on operations other than communications parameter setup, refer to the *E5□C Digital Temperature Controllers User's Manual* (Cat. No. H174) for the devices being used.

- (1) Press the  Key for at least three seconds to move from the "operation level" to the "initial setting level."
- (2) Press the  Key for less than one second to move from the "initial setting level" to the "communications setting level."
- (3) Select the parameters as shown below by pressing the  Key.
- (4) Use the  or  Keys to change the parameter set values.

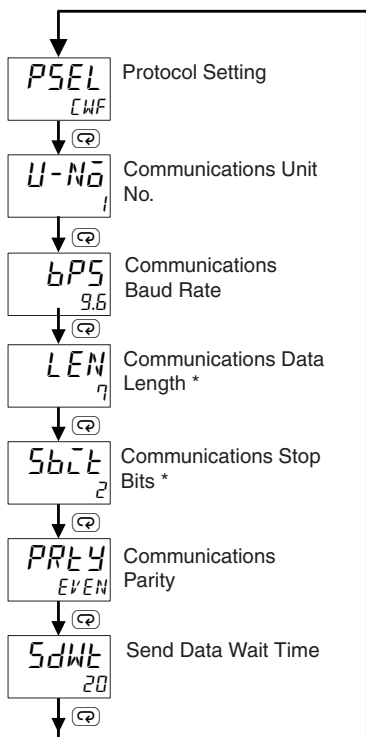

\* Displayed only when the Protocol Setting parameter is set to CompoWay/F.

### 1-1-8 Description of Communications Parameters

When communications parameter settings have been changed, the new settings must be enabled by resetting the Controller.

- Protocol Setting (*PSEL*)  
The communications protocol can be selected. Set CompoWay/F or Modbus.
- Communications Unit No. (*U-NO*)  
This parameter is for setting a unique unit number for each of the Digital Controllers. This unit number is set so that the host can identify the Digital Controller when communications are carried out with the host. The unit number can be set to an integer value between 0 and 99. The default is "1." When two or more Digital Controllers are used, do not set the same unit number. Doing so will prevent normal operation.
- Communications Baud Rate (*BR*)  
This parameter is for setting the baud rate for communications with the host. The communications baud rate settings are as follows: 9.6 (9600 bps), 19.2 (19200 bps), 38.4 (38400 bps) or 57.6 (57600 bps)
- Communications Data Length (*LEN*)  
This parameter is for setting the number of communications data bits. Set either "7 bits" or "8 bits."
- Communications Stop Bits (*SB*)  
This parameter is for setting the number of communications stop bits. Set either "1" or "2."
- Communications Parity (*PRTY*)  
This parameter is for setting the communications parity. Set the parity to "none," "even," or "odd."
- Send Data Wait Time (*SDWT*)  
The send data wait time is the delay from when the Controller receives a command from the host computer until it returns a response. If the response is returned too quickly, the host computer may not be able to receive the response. Change the send data wait time as required. To increase the response speed for communications, reduce the send data wait time. The send data wait time can be set in 1-ms increments between 0 and 99 ms. The default is 20 ms.

# 2

## CompoWay/F Communications Procedures

Read this section if you are to communicate using the CompoWay/F format.

---

<b>2-1</b>	<b>Data Format</b>	<b>2-2</b>
2-1-1	Command Frame	2-2
2-1-2	BCC Calculation Example	2-3
2-1-3	Response Frame	2-3
2-1-4	Communications Data	2-4
2-1-5	End Code Example	2-4
<b>2-2</b>	<b>Structure of Command Text</b>	<b>2-6</b>
2-2-1	PDU Structure	2-6
2-2-2	Area Definitions	2-6
2-2-3	Type Code (Variable Type)	2-6
2-2-4	Addresses	2-7
2-2-5	Number of Elements	2-7
2-2-6	List of Services (Main Request Codes and Sub-Request Codes)	2-7
<b>2-3</b>	<b>Detailed Description of the Services</b>	<b>2-8</b>
2-3-1	Read Variable Area	2-8
2-3-2	Write Variable Area	2-9
2-3-3	Composite Read from Variable Area	2-10
2-3-4	Composite Write to Variable Area	2-12
2-3-5	Read Controller Attributes	2-13
2-3-6	Read Controller Status	2-14
2-3-7	Echoback Test	2-15
2-3-8	Operation Command	2-16
<b>2-4</b>	<b>Response Code List</b>	<b>2-21</b>

## 2-1 Data Format

Hexadecimal values are expressed by adding the prefix H' before the number, e.g., H'02. Numbers shown without the H' prefix are ASCII characters.

The number underneath each item in a frame indicates the number of bytes.

### 2-1-1 Command Frame

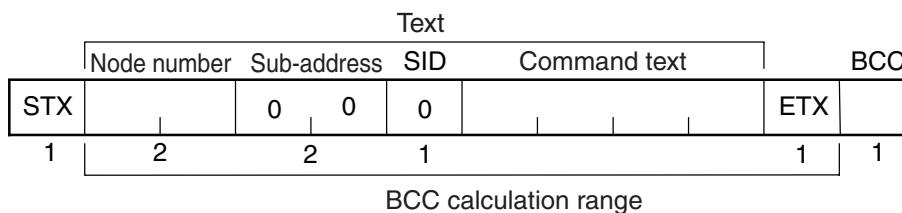

<b>STX</b>	This code (H'02) indicates the beginning of the communications frame (text). Always set this character in the first byte. When STX is received again during reception, reception is carried out again from the point where STX was received.
<b>Node number</b>	<ul style="list-style-type: none"> <li>This number specifies the transmission's destination.</li> <li>Specify the E5□C's communications unit number.</li> <li>A BCD value between 00 and 99 or an ASCII value of XX can be set.</li> <li>Specify "XX" for a broadcast transmission. No responses will be returned for broadcast transmissions.</li> <li>No responses will be returned from node numbers other than the ones in the above range.</li> </ul>
<b>Sub-address</b>	Always set the sub-address to "00."
<b>SID (Service ID)</b>	Always set the service ID to "0."
<b>Command text</b>	This is the command text area. For details, refer to <i>2-2 Structure of Command Text</i> .
<b>ETX</b>	This code (H'03) indicates the end of the text.
<b>BCC</b>	This is the Block Check Character. The BCC result is found by calculating the exclusive OR of the bytes from the node number up to ETX.

### 2-1-2 BCC Calculation Example

The BCC (Block Check Character) is determined by calculating the exclusive OR of the bytes from the node number up to ETX. The 8-bit result is written to the BCC byte at the end of the frame.

STX	Node number		Sub-address		SID	Command text			ETX	BCC	
02H	0 (30H)	0 (30H)	0 (30H)	0 (30H)	0 (30H)	0 (30H)	5 (35H)	0 (30H)	3 (33H)	03H	35H

$$BCC = 30H \oplus 30H \oplus 30H \oplus 30H \oplus 30H \oplus 30H \oplus 35H \oplus 30H \oplus 33H \oplus 03H = 35H$$

The result of the calculation (35 hex) is written to the BCC byte.

The ⊕ symbols indicate XOR (exclusive OR) operations.

### 2-1-3 Response Frame

	Node number		Sub-address		End code	Command text			ETX	BCC
STX		0	0							
1	2	2	2					1	1	

End code	Name	Description	Error detection priority
00	Normal completion	The command ended normally without error.	None
0F	FINS command error	The specified FINS command could not be executed. The FINS response code should indicate why the command could not be executed.	8
10	Parity error	The sum total of bits whose received data is "1" does not match the set value of the "communications parity" bit.	2
11	Framing error	Stop bit is "0."	1
12	Overrun error	An attempt was made to transfer new data when the reception data buffer was already full.	3
13	BCC error	The calculated BCC value is different from the received BCC value.	5
14	Format error	<ul style="list-style-type: none"> <li>The command text contains characters other than 0 to 9, and A to F. This error does not apply to Echoback Tests. (Refer to 2-3-7 Echoback Test for details.)</li> <li>There was no SID and command text. There was no command text.</li> <li>"MRC/SRC" not included in command text.</li> </ul>	7
16	Sub-address error	<ul style="list-style-type: none"> <li>Illegal (unsupported) sub-address</li> <li>There was no sub-address, SID, and command text.</li> <li>Sub-address was less than two characters, and there was no SID and command text</li> </ul>	6
18	Frame length error	The received frame exceeds the specified (supported) number of bytes.	4

- An end code is returned for each command frame received that was addressed to the local node.
- No response will be returned unless the frame contained all elements up to the ETX and BCC.
- "Error Detection Priority" indicates the priority when two or more errors occur simultaneously.

## 2-1-4 Communications Data

Communications format	Set (monitor) values	Negative values	Decimal point
CompoWay/F	8-digit hexadecimal	2's complement	Decimal point is removed and the result is converted to hexadecimal. Example conversion: 105.0 → 1050 → H'0000041A

## 2-1-5 End Code Example

The following examples show the end code when a command did not end normally.

Example 1) Illegal Sub-address, No SID, and No Command Text

- Command

	Node number	Sub-address	BCC
STX		0 A	ETX

- Response

	Node number	Sub-address	End code	BCC
STX		0 A	1 6	ETX

End code is "16" (sub-address error).

The sub-address error code is used because the sub-address error has a higher error detection priority than the format error.

Example 2) No Command Text

- Command

	Node number	Sub-address	SID	BCC
STX		0 0	0	ETX

- Response

	Node number	Sub-address	End code	BCC
STX		0 0	1 4	ETX

The end code is "14" (format error).

Example 3) No Node Number Provided

- Command

	BCC
STX	ETX

The node number is lacking one character.

- Response

There is no response.

## Example 4) No Sub-address and Illegal BCC

- Command

Node number		BCC	
STX		ETX	Err

- Response

Node number		Sub-address		End code		BCC	
STX		0	0	1	3	ETX	

The sub-address is "00" and the end code is "13" (BCC error).

## 2-2 Structure of Command Text

### 2-2-1 PDU Structure

An MRC (Main Request Code) and SRC (Sub-Request Code) followed by the various required data is transferred to the command text.

- Service Request PDU

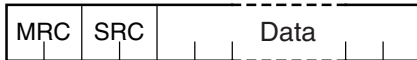

The MRES (Main Response Code) and SRES (Sub-Response Code) are transferred to the response frame following the above MRC/SRC. Data is then transferred following the MRES and SRES.

- Service Response PDU (Normal Response)

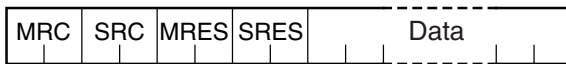

If the specified command text could not be executed, the service response PDU will contain only the MRC/SRC and MRES/SRES.

- Service Response PDU (Command Text Not Executed)

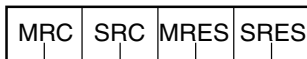

MRES/SRES provides the response code. MRES/SRES are not output when processing ends in a normal completion.

### 2-2-2 Area Definitions

Areas comprise only the variable area.

### 2-2-3 Type Code (Variable Type)

The following figure shows the variable area type code.

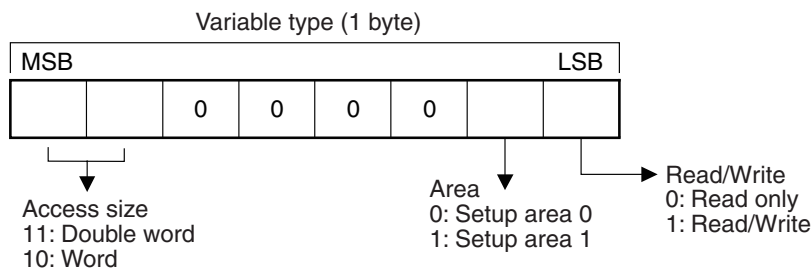

The following table summarizes setup areas 0 and 1.

Area	Description
Setup area 0	This area groups together the protect, manual control, operation, and adjustment levels.
Setup area 1	This area groups together the initial setting, communications setting, advanced function setting, and calibration levels.

The type code depends on the parameter. Refer to *3-1 Variable Area (Setting Range) List* for details.



The variable type is converted to 2-byte ASCII and loaded to the frame. The following table shows the available variable types.

Variable type	Description
C0/80	R/O (read only) parameter for setup area 0.
C1/81	R/W parameter for setup area 0.
C3/83	R/W parameter for setup area 1.

Note: Setup area 1 has no read-only parameters, so there is no variable type "C2."

## 2-2-4 Addresses

An address is appended to each of the variable types. Express addresses in 2-byte hexadecimal and append them for the specified access size. The address depends on the parameter. Refer to *3-1 Variable Area (Setting Range) List* for details.

## 2-2-5 Number of Elements

The number of elements is expressed in 2-byte hexadecimal. The range that can be specified for the number of elements depends on the command. Refer to *2-3 Detailed Description of the Services* for details.

## 2-2-6 List of Services (Main Request Codes and Sub-Request Codes)

MRC	SRC	Name of service	Processing
01	01	Read Variable Area	This service reads from the variable area.
01	02	Write Variable Area	This service writes to the variable area.
01	04	Composite Read from Variable Area	This service reads from the variable area in the order specified by the parameters.
01	13	Composite Write to Variable Area	This service writes to the variable area in the order specified by the parameters.
05	03	Read Controller Attributes	This service reads the model number and communications buffer size.
06	01	Read Controller Status	This service reads the operating status.
08	01	Echoback Test	This service performs an echoback test.
30	05	Operation Command	This service performs operations such as RUN/STOP, executing/stopping AT (auto-tuning), and moving to Setup Area 1.

Note: No commands will be accepted and no responses will be returned when a memory error (RAM error) has occurred or the Controller is initializing (until the Controller recognizes the process value after the power is turned ON).

## 2-3 Detailed Description of the Services

### 2-3-1 Read Variable Area

This service reads data from the variable area.

- Service Request PDU

MRC	SRC	Variable type	Read start address	Bit position	Number of elements
0   1	0   1			0   0	
2	2	2	4	2	4

- Service Response PDU

MRC	SRC	Response code	Read data (for number of elements)
0   1	0   1		
2	2	4	Number of elements × 8 or 4

#### (1) Variable Type and Read Start Address

For details on variable types and read start addresses, refer to *Section 3 Communications Data for CompoWay/F*.

#### (2) Bit Position

Bit access is not supported. Fixed to “00.”

#### (3) Number of Elements

Number of elements	Processing
0000	The read operation is not performed (read data is not appended to the service response PDU), and processing ends in a normal completion.
Double word (variable type C0, C1, or C3)	0001 to 0019 (1 to 25)
Word (variable type 80, 81, or 83)	0001 to 0032 (1 to 50)

#### (4) Response Code

- Normal Completion

Response code	Name	Description
0000	Normal completion	No errors were found.

- Error Occurred

Response code	Error name	Cause
1001	Command too long	The command is too long.
1002	Command too short	The command is too short.
1101	Area type error	The variable type is wrong.
1103	Start address out-of-range error	The read start address is out of range.
110B	Response too long	The number of elements exceeds the maximum.
1100	Parameter error	Bit position is not "00."
2203	Operation error	Non-volatile memory error

### (5) Precautions

- Alarm Function

Even though alarms are not displayed on the Controller's display, they function normally in communications.

## 2-3-2 Write Variable Area

This service writes data to the variable area.

- Service Request PDU

MRC	SRC	Variable type	Start write address	Bit position	Number of elements	Write Data (for number of elements)
0   1	0   2			0   0		
2	2	2	4	2	4	Number of elements × 8 or 4

- Service Response PDU

MRC	SRC	Response code
0   1	0   2	
2	2	4

### (1) Variable Type and Write Start Address

For details on variable types and write start addresses, refer to *Section 3 Communications Data for CompoWay/F*.

### (2) Bit Position

Bit access is not supported. Fixed to "00."

### (3) Number of Elements

Number of elements	Processing
0000	The write operation is not performed (do not append write data to the service request PDU) and processing ends in a normal completion.
Double word (variable type C0, C1, or C3)	0001 to 0018 (1 to 24)
Word (variable type 80, 81, or 83)	0001 to 0030 (1 to 48)

**(4) Response Code**

- Normal Completion

Response code	Name	Description
0000	Normal completion	No errors were found.

- Error Occurred

Response code	Error name	Cause
1002	Command too short	The command is too short.
1101	Area type error	The variable type is wrong.
1103	Start address out-of-range error	Write start address is out of range.
1104	End address out-of-range error	The write end address (write start address + number of elements) exceeds the final address of the variable area.
1003	Number of elements/data mismatch	The number of data does not match the number of elements.
1100	Parameter error	<ul style="list-style-type: none"> <li>• Bit position is not "00."</li> <li>• The write data is out of the setting range.</li> </ul>
3003	Read-only error	Variable type "C0" was written to.
2203	Operation error	<ul style="list-style-type: none"> <li>• The Communications Writing parameter is set to "OFF" (disabled).</li> <li>• Attempted to write to a parameter in setup area 1 from setup area 0.</li> <li>• Attempted to write to a protect parameter from other than the protect level.</li> <li>• AT (auto-tuning) was in progress. *</li> <li>• Non-volatile memory error</li> </ul>

\* For details on AT (auto-tuning), refer to the *E5□C Digital Temperature Controllers User's Manual* (Cat. No. H174).

**(5) Precautions**

- Alarm Function

Even though alarms are not displayed on the Controller's display, they function normally in communications.

**2-3-3 Composite Read from Variable Area**

This service reads in order the contents of specified addresses in the variable area.

- Service Request PDU

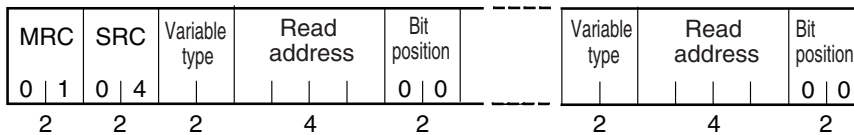

- Service Response PDU

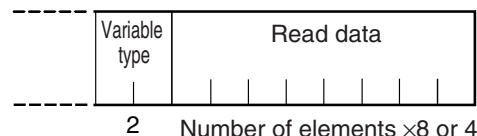
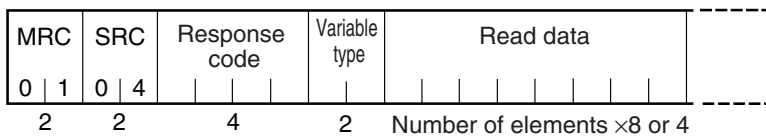

Note: The read data is read together with the variable type in the order specified by the command.

**(1) Variable Type and Read Start Address**

For details on variable types and read start addresses, refer to *Section 3 Communications Data for CompoWay/F*.

**(2) Bit Position**

Bit access is not supported. Fixed to "00."

**(3) Number of Read Data Items (Variable Type + Read Data + Bit Position Counted As 1 Item)**

Read data length	Number of read data items
For double word (variable type C0, C1, or C3)	20 max.
For word (variable type 80, 81, or 83)	25 max.

Note: The following table gives the maximum number of read data items when double-word data and word data are used together.

Composite Read		Composite Read	
Double word (variable type C0, C1, or C3)	Word (variable type 80, 81, or 83)	Double word (variable type C0, C1, or C3)	Word (variable type 80, 81, or 83)
20	0	11	14
19	1	10	15
18	2	9	16
18	3	8	17
17	4	7	18
17	5	6	19
16	6	8	20
15	7	4	21
15	8	3	22
14	9	2	23
14	10	1	24
13	11	0	25
12	12		
12	13		

**(4) Response Code**

- Normal Completion

Response code	Name	Description
0000	Normal completion	No errors were found.

- Error Occurred

Response code	Error name	Cause
1002	Command too short	The command is too short.
1101	Area type error	The variable type is wrong.
110B	Response too long	The number of elements exceeds the maximum.
1100	Parameter error	Bit position is not "00."
2203	Operation error	Non-volatile memory error

### 2-3-4 Composite Write to Variable Area

This service writes in order the contents of specified addresses to a variable area.

- Service Request PDU

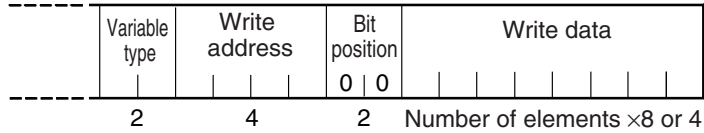
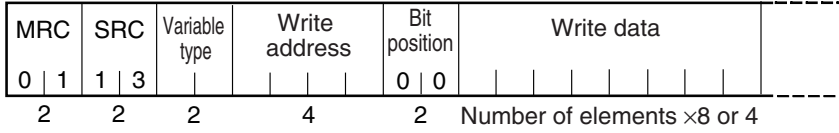

- Service Response PDU

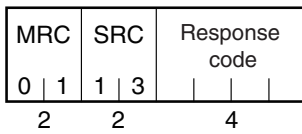

**(1) Variable Type and Write Start Address**

For details on variable types and write start addresses, refer to *Section 3 Communications Data for CompoWay/F*.

**(2) Bit Position**

Bit access is not supported. Fixed to “00.”

**(3) Number of Write Data Items (Variable Type + Write Address + Bit Position + Write Data Counted As 1 Item)**

Write data length	Number of write data items
For double word (variable type C0, C1, or C3)	12 max.
For word (variable type 80, 81, or 83)	17 max.

Note: The following table gives the maximum number of write data items when double-word data and word data are used together.

Composite Write	
Double word (variable type C0, C1, or C3)	Word (variable type 80, 81, or 83)
12	0
12	1
11	2
10	3
9	4
9	5
8	6
7	7
6	8
6	9

Composite Write	
Double word (variable type C0, C1, or C3)	Word (variable type 80, 81, or 83)
5	10
4	11
3	12
3	13
2	14
1	15
0	16
0	17

**(4) Response Code**

- Normal Completion

Response code	Name	Description
0000	Normal completion	No errors were found.

- Error Occurred

Response code	Error name	Cause
1002	Command too short	The command is too short.
1101	Area type error	The variable type is wrong.
1100	Parameter error	<ul style="list-style-type: none"> <li>• Bit position is not "00."</li> <li>• The write data is out of the setting range.</li> </ul>
3003	Read-only error	Variable type "C0" was written to.
2203	Operation error	<ul style="list-style-type: none"> <li>• The Communications Writing parameter is set to "OFF" (disabled).</li> <li>• Attempted to write to a parameter in setup area 1 from setup area 0.</li> <li>• Attempted to write to a protect parameter from other than the protect level.</li> <li>• AT (auto-tuning) was in progress. *</li> <li>• Non-volatile memory error</li> </ul>

\* For details on AT (auto-tuning), refer to the *E5□C Digital Temperature Controllers User's Manual* (Cat. No. H174).

**2-3-5 Read Controller Attributes**

This service reads the model number and communications buffer size.

- Service Request PDU

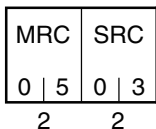

- Service Response PDU

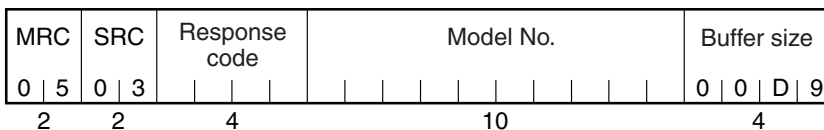

**(1) Model Number**

The model number is expressed in 10-byte ASCII.

Example: The model is given as shown below for the E5CC-RX2ASM-000 (relay output, 2 auxiliary outputs, and no options).

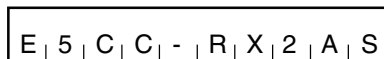

**(2) Buffer Size**

The communications buffer size is expressed in 2-byte hexadecimal, and read after being converted to 4-byte ASCII.

Buffer size: 217 bytes (= H'00D9)

**(3) Response Code**

- Normal Completion

Response code	Name	Description
0000	Normal completion	No errors were found.

- Error Occurred

Response code	Error name	Description
1001	Command too long	The command is too long.
2203	Operation error	Non-volatile memory error

**2-3-6 Read Controller Status**

This service reads the operating status and error status.

- Service Request PDU

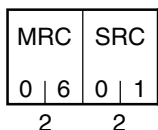

- Service Response PDU

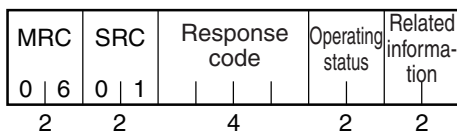

**(1) Operating Status**

Operating status	Description
00	Control is being carried out (error has not occurred in setup area 0 and the Controller is running).
01	Control is not being carried out (state other than above).

**(2) Related Information**

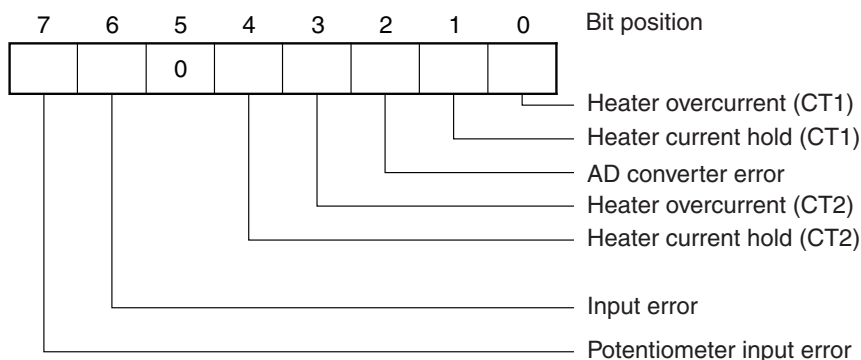



**(3) Response Code**

- Normal Completion

Response code	Name	Description
0000	Normal completion	No errors were found.

- Error Occurred

Response code	Error name	Description
1001	Command too long	The command is too long.
2203	Operation error	Non-volatile memory error

**2-3-7 Echoback Test**

This service performs an echoback test.

- Service Request PDU

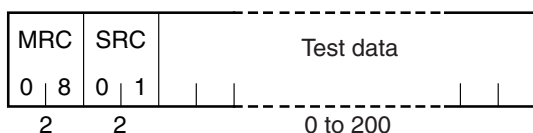

- Service Response PDU

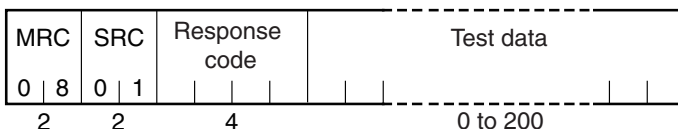
**(1) Test Data**

Set between 0 and 200 bytes of user-defined test data.

Set a value for the test data within the ranges shown below according to the communications data length.

Communications data length	Test Data
8 bits	ASCII data: H'20 to H'7E or H'A1 to H'FE
7 bits	ASCII data: H'20 to H'7E

**(2) Response Code**

- Normal Completion

Response code	Name	Description
0000	Normal completion	No errors were found.

- Error Occurred

Response code	Error name	Description
1001	Command too long	The command is too long.
2203	Operation error	Non-volatile memory error

### 2-3-8 Operation Command

- Communications Writing
- AT Execute/Cancel
- Software Reset
- Auto/Manual Switch
- Invert Direct/Reverse Operation
- RUN/STOP
- Write Mode
- Move to Setup Area 1
- Parameter Initialization
- Program Start
- Multi-SP
- Save RAM Data
- Move to Protect Level
- Alarm Latch Cancel
- SP Mode

• Service Request PDU

MRC	SRC	Com- mand code	Related infor- mation
3   0	0   5		
2	2	2	2

• Service Response PDU

MRC	SRC	Response code
3   0	0   5	
2	2	4

(1) Command Code and Related Information

Command code	Command content	Related Information
00	Communications Writing	00: OFF (disabled) 01: ON (enabled)
01	RUN/STOP	00: Run 01: Stop
02	Multi-SP	00: Set point 0 01: Set point 1 02: Set point 2 03: Set point 3 04: Set point 4 05: Set point 5 06: Set point 6 07: Set point 7
03	AT Execute/Cancel	00: AT cancel 01: 100% AT execute 02: 40% AT execute
04	Write Mode	00: Backup 01: RAM write mode
05	Save RAM Data	00
06	Software Reset	00
07	Move to Setup Area 1	00
08	Move to Protect Level	00
09	Auto/Manual Switch	00: Automatic mode 01: Manual mode
0B	Parameter Initialization	00

Command code	Command content	Related Information
0C	Alarm Latch Cancel	00: Alarm 1 latch cancel 01: Alarm 2 latch cancel 02: Alarm 3 latch cancel 03: HB alarm latch cancel 04: HS alarm latch cancel 05: Alarm 4 latch cancel 0F: All alarm latch cancel
0D	SP Mode	00: Local SP mode 01: Remote SP mode
0E	Invert Direct/Reverse Operation	00: Not invert 01: Invert
11	Program Start	00: Reset 01: Start

**(2) Response Code**

- Normal Completion

Response code	Name	Description
0000	Normal completion	No errors were found.

- Error Occurred

Response code	Error name	Description
1001	Command too long	The command is too long.
1002	Command too short	The command is too short.
1100	Parameter error	Command code and related information are wrong.
2203	Operation error	<ul style="list-style-type: none"> <li>• The Communications Writing parameter is set to "OFF" (disabled). The command is received regardless of the Communications Writing parameter setting (ON/OFF).</li> <li>• Processing could not be performed. For details, refer to (3) <i>Operation Commands and Precautions</i> below.</li> <li>• Non-volatile memory error</li> </ul>

**(3) Operation Commands and Precautions**

- Communications Writing

Set the Communications Writing parameter to "ON: enabled" or "OFF: disabled" with the related information setting. The setting can be accepted in both setup area 0 and setup area 1. An operation error will occur, however, if enabling or disabling communications writing is set for an event input.

- RUN/STOP

Set control to "run" or "stop" with the related information setting. The setting can be accepted in both setup area 0 and setup area 1. An operation error will occur, however, if RUN/STOP is set for an event input.

- Multi-SP

Set eight set points beforehand in the adjustment level so that you can switch to a desired set point. The setting can be accepted in both setup area 0 and setup area 1. An operation error will occur in the following situations.

- When AT is being executed.
- When the Number of Multi-SP Points parameter is set to OFF.
- When the Number of Multi-SP Points parameter is not set to OFF, but Multi-SP No. Switch is set for an event input.

- AT Execute/Cancel

Set AT (auto-tuning) to “execute” or “cancel” with the related information setting. This command can be accepted in setup area 0 only. An “operation error” will be generated in the following instances:

- When the RUN/STOP parameter is set to “stop”
- When the command is executed in “setup area 1”
- When ON/OFF control is being used
- When 40% AT is specified during 100% AT execution.
- When 100% AT is specified during 40% AT execution.

A parameter error will occur if 40% AT is specified during heating and cooling control or floating position-proportional control.

Note: If the same type of AT execution is specified during AT execution (e.g., if 100% AT is specified during 100% AT execution), the AT will not be restarted and the operation will end in normal completion with no processing.

- Write Mode

Set either the backup mode or RAM write mode with the related information setting. The setting can be accepted in both setup area 0 and setup area 1.

The number of non-volatile memory write operations is limited. Therefore, use RAM write mode when frequently overwriting data.

Write mode	Description
Backup mode	The data is written to non-volatile memory when the parameters in the operation/adjustment levels (excluding read-only parameters) are written by communications.
RAM write mode	The data is not written to non-volatile memory when the parameters in the operation/adjustment levels (excluding read-only parameters) are written by communications. Parameters can be changed by operating the keys on the front panel of the Controller.

- When the mode is switched from RAM write mode to backup mode, the parameters in the operation/adjustment levels (excluding read-only parameters) are written to non-volatile memory.
- The RAM write mode is enabled only when the Communications Writing parameter is set to “ON” (enabled).  
Consequently, when the Communications Writing parameter setting is changed to “OFF” (disabled), the parameters in the operation/adjustment levels (excluding read-only parameters) are written to non-volatile memory even if the mode is set to RAM write mode.

- Save RAM Data

This command writes the parameters in the operation/adjustment levels (excluding read-only parameters) to non-volatile memory. The setting can be accepted in both setup area 0 and setup area 1.

- **Software Reset**  
Restarts processing from the point when power is turned ON. The setting can be accepted in both setup area 0 and setup area 1.
- **Move to Setup Area 1**  
This command moves to “setup area 1” and can be accepted at both setup areas 0 and 1. If the “initial setting/communications protect” is set to “2,” an “operation error” will be generated, and the move to setup area 1 will be prohibited.  
When this move is carried out from setup area 0, the display indicates the Input Type parameter in the “initial setting level.” When this operation command is executed in setup area 1, the display will not change.
- **Move to Protect Level**  
This command moves to the "protect level" and can be accepted only in setup area 0. When this command is issued in setup area 1, an "operation error" will be generated, and the move to the protect level will be prohibited.
  - **Moving to Protect Level in Manual Mode**  
When this operation command is issued in manual mode, an “operation error” will be generated, and the move to the protect level will be prohibited.
- **Auto/Manual Switch**  
This operation command switches the mode to manual mode or automatic mode, based on the related information setting. This command can be accepted in setup area 0 only. An “operation error” will be generated in the following instances:
  - **When the command is executed in “setup area 1”**  
When the Controller is switched to manual mode, the “manual manipulated variable” will be displayed. When the Controller is switched from manual mode to automatic mode, the operation level's first parameter will be displayed. When the Controller is switched to auto mode while already in auto mode or switched to manual mode while already in manual mode, the command will be completed normally and the display will not change (the contents will not be refreshed).
- **Writing Auto/Manual Status in Non-volatile memory**  
The write mode determines whether the auto/manual status is written to non-volatile memory.
 

Write mode	Description
Backup mode	When the auto/manual mode is switched by communications, the auto/manual status is written to non-volatile memory.
RAM write mode	When the auto/manual mode is switched by communications, the auto/manual status is not written to non-volatile memory. The status can be written with the Controller key operation.

Note: When the auto/manual mode is switched with an operation command through communications and the Controller is in RAM write mode, the auto/manual status is not stored in non-volatile memory. Consequently, if the Controller is restarted by performing a software reset or turning the power OFF and ON again, the auto/manual mode is set to the last saved status.
- **Switching to Manual Mode during Auto-tuning**  
If the mode is switched during auto-tuning (AT), the AT will be cancelled and the Controller will be switched to manual mode.
- **Parameter Initialization**  
The present settings are returned to the default values and written to non-volatile memory. This command can be accepted in setup area 1 only. When this command is issued in setup area 0, an

“operation error” will be generated. (These settings are the same as the ones used when “FACT” is selected for the setting data's set value initialization.)

- Alarm Latch Cancel

The applicable alarm latch can be cleared with the related information setting. The setting can be accepted in both setup area 0 and setup area 1. An operation error will occur if communications writing is disabled or if a non-volatile memory error occurs.

- Invert Direct/Reverse Operation

Inverting or not inverting direct/reverse operation can be selected with the related information setting. The setting can be accepted in both setup area 0 and setup area 1. The related information specifications are written to non-volatile memory according to the write mode settings. An operation error will occur in the following situations:

- When AT is being executed.
- When inverting direct/reverse operation is set for an event input.
- When executed in manual mode.

- Program Start

The simple program function can be reset/started with the related information setting. The setting can be accepted in both setup area 0 and setup area 1. An operation error will be generated if program start has been set in the event input.

- Setting Areas

Control operation is executed in setting area 0. In this state, you can perform operations that are permitted only during control or those that cause no problems even if control is in progress. These operations include reading PVs, writing SPs, and changing RUN/STOP status.

Setting area 0, however, prohibits operations that affect control, including writing data at the initial setting level. (Reading setting data is always allowed.)

In setting area 1, control operation is stopped. In this state, you can perform operations that are not allowed in setting area 0. These operations include writing data at the initial setting level.

At power-ON, the Digital Controller is set in setting area 0. To move to setting area 1, use the "move-to-setting area 1" command. To return to setting area 0, turn the power OFF and ON again, or use the "software reset" command.

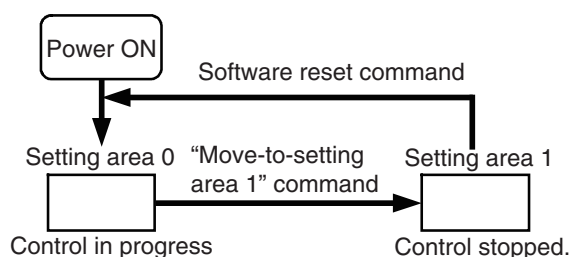

## 2-4 Response Code List

### Normal Completion

Response code	Name	Description	Error detection priority
0000	Normal completion	No errors were found.	None

### Error Occurred

Response code	Name	Description	Error detection priority
0401	Unsupported command	The service function for the relevant command is not supported.	1
1001	Command too long	The command is too long.	2
1002	Command too short	The command is too short.	3
1101	Area type error	Wrong variable type	4
1103	Start address out-of-range error	The read/write start address is out of range.	5
1104	End address out-of-range error	The write end address (write start address + number of elements) exceeds the final address of the variable area.	6
1003	Number of elements/data mismatch	The amount of data does not match the number of elements.	7
110B	Response too long	The response length exceeds the communications buffer size (when the number of elements is greater than the maximum number of elements for that service).	8
1100	Parameter error	<ul style="list-style-type: none"> <li>• Bit position is not "00."</li> <li>• The write data is out of the setting range.</li> <li>• The command code or related information in the operation command is wrong.</li> </ul>	9
3003	Read-only error	Variable type "C0" was written to.	10
2203	Operation error	<ul style="list-style-type: none"> <li>• The Communications Writing parameter is set to "OFF" (disabled).</li> <li>• Attempted to write to a parameter in setup area 1 from setup area 0.</li> <li>• Attempted to write to a protect parameter from other than the protect level.</li> <li>• Writing was carried out during AT execution.</li> <li>• Processing is not possible by operation command.</li> <li>• Non-volatile memory error</li> </ul>	11





# 3

## Communications Data for CompoWay/F

This section lists the details of the communications data in the CompoWay/F communications protocol.

---

<b>3-1 Variable Area (Setting Range) List .....</b>	<b>3-2</b>
<b>3-2 Status and Status 2 .....</b>	<b>3-22</b>

## 3-1 Variable Area (Setting Range) List

- For communications using a variable type not enclosed in parentheses in the following table, the set value is double-word data (8 digits). For communications using a variable type enclosed in parentheses, the set value is single-word data (4 digits).
- For example, variable type C0 is double-word data (8 digits), and variable type 80 is single-word data (4 digits).
- Items expressed in hexadecimal in the "Setting (monitor) value" column are the setting range for CompoWay/F communications. The values in parentheses are the actual setting range. When there is a section reference for a setting item, refer to that reference for details.

Variable type	Address	Parameter name	Setting (monitor) value	Level
C0 (80)	0000	PV	Temperature: Use the specified range for each sensor. Analog:       Scaling lower limit –5% FS to Scaling upper limit +5% FS	Operation
C0 (80)	0001	Status <sup>*1</sup> *2	Refer to 3-2 <i>Status and Status 2</i> for details.	
C0 (80)	0002	Internal Set Point <sup>*1</sup>	SP lower limit to SP upper limit	
C0 (80)	0003	Heater Current 1 Value Monitor	H'00000000 to H'00000226 (0.0 to 55.0)	
C0 (80)	0004	MV Monitor (Heating)	Standard:           H'FFFFFFCE to H'0000041A (–5.0 to 105.0) Heating and cooling: H'00000000 to H'0000041A (0.0 to 105.0)	
C0 (80)	0005	MV Monitor (Cooling)	H'00000000 to H'0000041A (0.0 to 105.0)	
C0 (80)	0006	Heater Current 2 Value Monitor	H'00000000 to H'00000226 (0.0 to 55.0)	
C0 (80)	0007	Leakage Current 1 Monitor	H'00000000 to H'00000226 (0.0 to 55.0)	
C0 (80)	0008	Leakage Current 2 Monitor	H'00000000 to H'00000226 (0.0 to 55.0)	
C0 (80)	0009	Soak Time Remain	H'00000000 to H'0000270F (0 to 9999)	
C0 (80)	000A	Valve Opening Monitor	H'FFFFFF9C to H'0000044C (–10.0 to 110.0)	
C0 (80)	000B	Remote SP Monitor	Remote SP lower limit –10%FS to Remote SP upper limit +10%FS	
C0 (80)	000C	Multi-SP No. Monitor	H'00000000 to H'00000007 (0 to 7)	
C0 (80)	000E	Decimal Point Monitor <sup>*1</sup>	H'00000000 to H'00000003 (0 to 3)	
C0 (80)	0011	Status 2 <sup>*1</sup> *2	Refer to 3-2 <i>Status and Status 2</i> .	
C0 (80)	0012	Status <sup>*1</sup> *3	Refer to 3-2 <i>Status and Status 2</i> .	
C0 (80)	0013	Status 2 <sup>*1</sup> *3	Refer to 3-2 <i>Status and Status 2</i> .	

\*1 Not displayed on the Controller display.

\*2 When the variable type is 80 (word access), the rightmost 16 bits are read.

\*3 When the variable type is 80 (word access), the leftmost 16 bits are read.

Variable type	Address	Parameter name	Setting (monitor) value	Level
C1 (81)	0000	Operation/Adjustment Protect	H'00000000 (0): No restrictions in operation and adjustment levels H'00000001 (1): Move to adjustment level is prohibited. H'00000002 (2): Display and change of only "PV" and "PV/SP" parameters is allowed. H'00000003 (3): Display of only "PV" and "PV/SP" parameters is allowed.	Protect
C1 (81)	0001	Initial Setting/Communications Protect	H'00000000 (0): Move to initial setting/communications setting level is allowed. (Move to advanced function setting level is displayed.) H'00000001 (1): Move to initial setting/communications setting level is allowed. (Move to advanced function setting level is not displayed.) H'00000002 (2): Move to initial setting/communications setting level is prohibited.	
C1 (81)	0002	Setting Change Protect	H'00000000 (0): OFF (Changing of setup on Controller display is allowed.) H'00000001 (1): ON (Changing of setup on Controller display is prohibited.)	
C1 (81)	0003	Set Point	SP lower limit to SP upper limit	Operation
C1 (81)	0004	Alarm Value 1	H'FFFFFF831 to H'0000270F (-1999 to 9999)	
C1 (81)	0005	Alarm Value Upper Limit 1	H'FFFFFF831 to H'0000270F (-1999 to 9999)	
C1 (81)	0006	Alarm Value Lower Limit 1	H'FFFFFF831 to H'0000270F (-1999 to 9999)	
C1 (81)	0007	Alarm Value 2	H'FFFFFF831 to H'0000270F (-1999 to 9999)	
C1 (81)	0008	Alarm Value Upper Limit 2	H'FFFFFF831 to H'0000270F (-1999 to 9999)	
C1 (81)	0009	Alarm Value Lower Limit 2	H'FFFFFF831 to H'0000270F (-1999 to 9999)	
C1 (81)	000A	Alarm Value 3	H'FFFFFF831 to H'0000270F (-1999 to 9999)	
C1 (81)	000B	Alarm Value Upper Limit 3	H'FFFFFF831 to H'0000270F (-1999 to 9999)	
C1 (81)	000C	Alarm Value Lower Limit 3	H'FFFFFF831 to H'0000270F (-1999 to 9999)	
C1 (81)	000D	Heater Burnout Detection 1	H'00000000 to H'000001F4 (0.0 to 50.0)	Adjustment
C1 (81)	000E	SP 0	SP lower limit to SP upper limit	
C1 (81)	000F	SP 1	SP lower limit to SP upper limit	
C1 (81)	0010	SP 2	SP lower limit to SP upper limit	
C1 (81)	0011	SP 3	SP lower limit to SP upper limit	
C1 (81)	0012	Process Value Input Shift	H'FFFFFF831 to H'0000270F (-1999 to 9999)	
C1 (81)	0013	Process Value Slope Coefficient	H'00000001 to H'0000270F (0.001 to 9.999)	
C1 (81)	0015	Proportional Band	H'00000001 to H'0000270F (0.1 to 999.9)	

Note: The alarm function can also be used in Digital Temperature Controllers that do not have any auxiliary outputs. In this case, confirm alarm occurrences via the status data.

Variable type	Address	Parameter name	Setting (monitor) value	Level
C1 (81)	0016	Integral Time	Standard, heating/cooling, or close position-proportional control: H'00000000 to H'0000270F (0 to 9999: Integral/derivative time unit is 1 s.) (0.0 to 999.9: Integral/derivative time unit is 0.1 s.) Floating position-proportional control: H'00000001 to H'0000270F (1 to 9999: Integral/derivative time unit is 1 s.) (0.1 to 999.9: Integral/derivative time unit is 0.1 s.)	Adjustment
C1 (81)	0017	Derivative Time	H'00000000 to H'0000270F (0 to 9999: Integral/derivative time unit is 1 s.) (0.0 to 999.9: Integral/derivative time unit is 0.1 s.)	
C1 (81)	0019	Dead Band	H'FFFFFF831 to H'0000270F (-199.9 to 999.9 for temperature input) (-19.99 to 99.99 for analog input)	
C1 (81)	001A	Manual Reset Value	H'00000000 to H'000003E8 (0.0 to 100.0)	
C1 (81)	001B	Hysteresis (Heating)	H'00000001 to H'0000270F (0.1 to 999.9 for temperature input) (0.01 to 99.99 for analog input)	
C1 (81)	001C	Hysteresis (Cooling)	H'00000001 to H'0000270F (0.1 to 999.9 for temperature input) (0.01 to 99.99 for analog input)	
C1 (81)	001D	Heater Burnout Detection 2	H'00000000 to H'000001F4 (0.0 to 50.0)	
C1 (81)	001E	HS Alarm 1	H'00000000 to H'000001F4 (0.0 to 50.0)	
C1 (81)	001F	HS Alarm 2	H'00000000 to H'000001F4 (0.0 to 50.0)	
C1 (81)	0020	Soak Time	H'00000001 to H'0000270F (1 to 9999)	
C1 (81)	0021	Wait Band	H'00000000 (0): OFF H'00000001 to H'0000270F (0.1 to 999.9 for temperature input) (0.01 to 99.99 for analog input)	
C1 (81)	0022	MV at Stop	Standard Models	
C1 (81)	0023	MV at PV Error	Standard control: H'FFFFFFFCE to H'0000041A (-5.0 to 105.0) Heating and cooling control: H'FFFFFFBE6 to H'0000041A (-105.0 to 105.0) Position-proportional Models Close position-proportional control with the Direct Setting of Position Proportional MV parameter set to ON: H'FFFFFFFCE to H'0000041A (-5.0 to 105.0) Floating position-proportional control or the Direct Setting of Position Proportional MV parameter set to OFF: (Not valid for manual MV.) H'FFFFFFF to H'00000001 (-1 to 1)	

Variable type	Address	Parameter name	Setting (monitor) value	Level
C1 (81)	0024	Manual MV	Standard Models Standard control: H'FFFFFFCE to H'0000041A (-5.0 to 105.0) Heating and cooling control: H'FFFFFFBE6 to H'0000041A (-105.0 to 105.0) Position-proportional Models Close position-proportional control with the Direct Setting of Position Proportional MV parameter set to ON: H'FFFFFFCE to H'0000041A (-5.0 to 105.0)	Manual Control
C1 (81)	0025	SP Ramp Set Value	H'00000000 (0): OFF H'00000001 to H'0000270F (1 to 9999)	Adjustment
C1 (81)	0026	MV Upper Limit	Standard control or close position-proportional control: MV lower limit + 0.1 to H'0000041A (MV lower limit + 0.1 to 105.0) Heating and cooling control: H'00000000 to H'0000041A (0.0 to 105.0)	
C1 (81)	0027	MV Lower Limit	Standard control or close position-proportional control: H'FFFFFFCE to MV upper limit - 0.1 (-5.0 to MV upper limit - 0.1) Heating and cooling control: H'FFFFFFBE6 to H'00000000 (-105.0 to 0.0)	
C1 (81)	0028	Move to Protect Level	H'FFFFFF831 to H'0000270F (--1999 to 9999)	Protect
C1 (81)	0029	Password to Move to Protect Level	H'FFFFFF831 to H'0000270F (-1999 to 9999) (Can only be set. The monitor value is always H'00000000.)	
C1 (81)	002A	Parameter Mask Enable	H'00000000 (0): OFF H'00000001 (1): ON	
C1 (81)	002B	PF Key Protect	H'00000000 (0): OFF H'00000001 (1): ON	

Variable type	Address	Parameter name	Setting (monitor) value	Level
C1 (81)	002C	MV Change Rate Limit	H'00000000 to H'000003E8 (0.0 to 100.0)	Adjustment
C1 (81)	002D	Position Proportional Dead Band	H'00000001 to H'00000064 (0.1 to 10.0)	
C1 (81)	002E	Open/Close Hysteresis	H'00000001 to H'000000C8 (0.1 to 20.0)	
C1 (81)	002F	Remote SP Input Shift	H'FFFFFF831 to H'0000270F (-1999 to 9999)	
C1 (81)	0030	Remote SP Slope Input Coefficient	H'00000001 to H'0000270F (0.001 to 9.999)	
C1 (81)	0031	Extraction of Square Root Low-cut Point	H'00000000 to H'000003E8 (0.0 to 100.0)	
C1 (81)	0032	Alarm Value 4	H'FFFFFF831 to H'0000270F (-1999 to 9999)	
C1 (81)	0033	Alarm Value Upper Limit 4	H'FFFFFF831 to H'0000270F (-1999 to 9999)	
C1 (81)	0034	Alarm Value Lower Limit 4	H'FFFFFF831 to H'0000270F (-1999 to 9999)	
C1 (81)	0035	SP 4	SP lower limit to SP upper limit	
C1 (81)	0036	SP 5	SP lower limit to SP upper limit	
C1 (81)	0037	SP 6	SP lower limit to SP upper limit	
C1 (81)	0038	SP 7	SP lower limit to SP upper limit	
C1 (81)	0039	Proportional Band (Cooling)	H'00000001 to H'0000270F (0.1 to 999.9)	
C1 (81)	003A	Integral Time (Cooling)	H'00000000 to H'0000270F (0 to 9999: Integral/derivative time unit is 1 s.) (0.0 to 999.9: Integral/derivative time unit is 0.1 s.)	
C1 (81)	003B	Derivative Time (Cooling)	H'00000000 to H'0000270F (0 to 9999: Integral/derivative time unit is 1 s.) (0.0 to 999.9: Integral/derivative time unit is 0.1 s.)	

Variable type	Address	Parameter name	Setting (monitor) value	Level	
C1 (81)	003C	SP Ramp Fall Value	H'FFFFFFFF (-1): Same (Same as SP Ramp Set Value.) H'00000000(0): OFF H'00000001 to H'0000270F (1 to 9999)	Adjustment	
C1 (81)	003D	Work Bit 1 ON Delay	H'00000000 to H'0000270F (0 to 9999)		
C1 (81)	003E	Work Bit 1 OFF Delay	H'00000000 to H'0000270F (0 to 9999)		
C1 (81)	003F	Work Bit 2 ON Delay	H'00000000 to H'0000270F (0 to 9999)		
C1 (81)	0040	Work Bit 2 OFF Delay	H'00000000 to H'0000270F (0 to 9999)		
C1 (81)	0041	Work Bit 3 ON Delay	H'00000000 to H'0000270F (0 to 9999)		
C1 (81)	0042	Work Bit 3 OFF Delay	H'00000000 to H'0000270F (0 to 9999)		
C1 (81)	0043	Work Bit 4 ON Delay	H'00000000 to H'0000270F (0 to 9999)		
C1 (81)	0044	Work Bit 4 OFF Delay	H'00000000 to H'0000270F (0 to 9999)		
C1 (81)	0045	Work Bit 5 ON Delay	H'00000000 to H'0000270F (0 to 9999)		
C1 (81)	0046	Work Bit 5 OFF Delay	H'00000000 to H'0000270F (0 to 9999)		
C1 (81)	0047	Work Bit 6 ON Delay	H'00000000 to H'0000270F (0 to 9999)		
C1 (81)	0048	Work Bit 6 OFF Delay	H'00000000 to H'0000270F (0 to 9999)		
C1 (81)	0049	Work Bit 7 ON Delay	H'00000000 to H'0000270F (0 to 9999)		
C1 (81)	004A	Work Bit 7 OFF Delay	H'00000000 to H'0000270F (0 to 9999)		
C1 (81)	004B	Work Bit 8 ON Delay	H'00000000 to H'0000270F (0 to 9999)		
C1 (81)	004C	Work Bit 8 OFF Delay	H'00000000 to H'0000270F (0 to 9999)		
C1 (81)	004D	Changed Parameters Only	H'00000000(0): OFF H'00000001(1): ON		Protect

Variable type	Address	Parameter name	Setting (monitor) value	Level
C3 (83)	0000	Input Type	H'00000000 (0): Pt (-200 to 850°C/-300 to 1500°F) H'00000001 (1): Pt (-199.9 to 500.0°C/-199.9 to 900.0°F) H'00000002 (2): Pt (0.0 to 100.0°C/0.0 to 210.0°F) H'00000003 (3): JPt (-199.9 to 500.0°C/-199.9 to 900.0°F) H'00000004 (4): JPt (0.0 to 100.0°C/0.0 to 210.0°F) H'00000005 (5): K (-200 to 1300°C/-300 to 2300°F) H'00000006 (6): K (-20.0 to 500.0°C/0.0 to 900.0°F) H'00000007 (7): J (-100 to 850°C/-100 to 1500°F) H'00000008 (8): J (-20.0 to 400.0°C/0.0 to 750.0°F) H'00000009 (9): T (-200 to 400°C/-300 to 700°F) H'0000000A (10): T (-199.9 to 400.0°C/-199.9 to 700.0°F) H'0000000B (11): E (-200 to 600°C/-300 to 1100°F) H'0000000C (12): L (-100 to 850°C/-100 to 1500°F) H'0000000D (13): U (-200 to 400°C/-300 to 700°F) H'0000000E (14): U (-199.9 to 400.0°C/-199.9 to 700.0°F) H'0000000F (15): N (-200 to 1300°C/-300 to 2300°F) H'00000010 (16): R (0 to 1700°C/0 to 3000°F) H'00000011 (17): S (0 to 1700°C/0 to 3000°F) H'00000012 (18): B (100 to 1800°C/300 to 3200°F) H'00000013 (19): W (0 to 2300°C/0 to 3200°F) H'00000014 (20): PL II (0 to 1300°C/0 to 2300°F) H'00000015 (21): Infrared temperature sensor (K 140°F/60°C) H'00000016 (22): Infrared temperature sensor (K 240°F/120°C) H'00000017 (23): Infrared temperature sensor (K 280°F/140°C) H'00000018 (24): Infrared temperature sensor (K 440°F/220°C) H'00000019 (25): 4 to 20 mA H'0000001A (26): 0 to 20 mA H'0000001B (27): 1 to 5 V H'0000001C (28): 0 to 5 V H'0000001D (29): 0 to 10 V H'0000001E (30): 0 to 50 mV* * Selection is possible only for E5CC-U Controllers and only if they are manufactured in May 2014 or later (version 2.2).	Initial setting
C3 (83)	0001	Scaling Upper Limit	Scaling lower limit + 1 to H'0000270F (Scaling lower limit + 1 to 9,999)	
C3 (83)	0002	Scaling Lower Limit	H'FFFFFF831 to Scaling upper limit - 1 (-1999 to Scaling upper limit - 1)	
C3 (83)	0003	Decimal Point	H'00000000 to 00000003 (0 to 3)	
C3 (83)	0004	Temperature Unit	H'00000000 (0): °C H'00000001 (1): °F	
C3 (83)	0005	SP Upper Limit	The range of values (without decimal point) is as follows: Temperature input: SP lower limit + 1 to Input range upper limit Analog input: SP lower limit + 1 to Scaling upper limit	



Variable type	Address	Parameter name	Setting (monitor) value	Level
C3 (83)	0006	SP Lower Limit	The range of values (without decimal point) is as follows: Temperature input: Input range lower limit to SP upper limit – 1 Analog input: Scaling lower limit to SP upper limit – 1	Initial setting
C3 (83)	0007	PID ON/OFF	H'00000000 (0): ON/OFF H'00000001 (1): 2 PID control	
C3 (83)	0008	Standard or Heating/Cooling	H'00000000 (0): Standard H'00000001 (1): Heating and cooling	
C3 (83)	0009	ST	H'00000000 (0): OFF H'00000001 (1): ON	
C3 (83)	000A	Control Period (Heating)	H'FFFFFFFE (-2): 0.1 s H'FFFFFFF (-1): 0.2 s H'00000000 (0): 0.5 s H'00000001 to H'00000063 (1 to 99)	
C3 (83)	000B	Control Period (Cooling)	H'FFFFFFFE (-2): 0.1 s H'FFFFFFF (-1): 0.2 s H'00000000 (0): 0.5 s H'00000001 to H'00000063 (1 to 99)	
C3 (83)	000C	Direct/Reverse Operation	H'00000000 (0): Reverse operation H'00000001 (1): Direct operation	
C3 (83)	000D	Alarm 1 Type	H'00000000 (0): Alarm function OFF H'00000001 (1): Upper and lower-limit alarm H'00000002 (2): Upper-limit alarm H'00000003 (3): Lower-limit alarm H'00000004 (4): Upper and lower-limit range alarm H'00000005 (5): Upper and lower-limit alarm with standby sequence H'00000006 (6): Upper-limit alarm with standby sequence H'00000007 (7): Lower-limit alarm with standby sequence H'00000008 (8): Absolute-value upper-limit alarm H'00000009 (9): Absolute-value lower-limit alarm H'0000000A (10): Absolute-value upper-limit alarm with standby sequence H'0000000B (11): Absolute-value lower-limit alarm with standby sequence H'0000000C (12): LBA (Loop Burnout Alarm) H'0000000D (13): PV change rate alarm H'0000000E (14): SP absolute-value upper-limit alarm H'0000000F (15): SP absolute-value lower-limit alarm H'00000010 (16): MV absolute-value upper-limit alarm H'00000011 (17): MV absolute-value lower-limit alarm H'00000012 (18): RSP absolute-value upper-limit alarm* H'00000013 (19): RSP absolute-value lower-limit alarm* * Valid only with a remote SP input.	
C3 (83)	000E	Alarm 2 Type	H'00000000 to H'00000013 (0 to 19) Note: Same settings as the Alarm 1 Type. However, the LBA (loop burnout alarm) cannot be set.	
C3 (83)	000F	Alarm 3 Type	H'00000000 to H'00000013 (0 to 19) Note: Same settings as the Alarm 1 Type. However, the LBA (loop burnout alarm) cannot be set.	

Variable type	Address	Parameter name	Setting (monitor) value	Level
C3 (83)	0010	Communications Unit No.* <sup>1</sup>	H'00000000 to H'00000063 (0 to 99)	Commu nications setting
C3 (83)	0011	Communications Baud Rate * <sup>1</sup>	H'00000003 (3): 9.6 H'00000004 (4): 19.2 H'00000005 (5): 38.4 H'00000006 (6): 57.6	
C3 (83)	0012	Communications Data Length * <sup>1</sup>	H'00000007 (7): 7 H'00000008 (8): 8	
C3 (83)	0013	Communications Stop Bits* <sup>1</sup>	H'00000001 (1): 1 H'00000002 (2): 2	
C3 (83)	0014	Communications Parity * <sup>1</sup>	H'00000000 (0): None H'00000001 (1): Even H'00000002 (2): Odd	

\*<sup>1</sup> After communications parameters have been changed, reset the Digital Controller to enable them.

Note: The alarm function can also be used in Digital Temperature Controllers that do not have any auxiliary outputs. In this case, confirm alarm occurrences via the status data.

Variable type	Address	Parameter name	Setting (monitor) value	Level
C3 (83)	0016	Event Input Assignment 1	H'00000000 (0): None H'00000001 (1): RUN/STOP H'00000002 (2): Auto/Manual Switch H'00000003 (3): Program Start <sup>*1</sup> H'00000004 (4): Direct/Reverse Operation H'00000005 (5): SP Mode Switch <sup>*2</sup> H'00000006 (6): 100% AT Execute/Cancel H'00000007 (7): 40% AT Execute/Cancel H'00000008 (8): Setting Change Enable/Disable H'00000009 (9): Communications Writing Enable/Disable <sup>*3</sup> H'0000000A (10): Alarm Latch Cancel H'0000000B (11): Multi-SP No. Switch, Bit 0 H'0000000C (12): Multi-SP No. Switch, Bit 1 H'0000000D (13): Multi-SP No. Switch, Bit 2	Initial setting
C3 (83)	0017	Event Input Assignment 2	H'00000000 to H'0000000D (0 to 13) Note: Same as for Event Input Assignment 1.	
C3 (83)	0018	Event Input Assignment 3	H'00000000 to H'0000000D (0 to 13) Note: Same as for Event Input Assignment 1.	
C3 (83)	0019	Event Input Assignment 4	H'00000000 to H'0000000D (0 to 13) Note: Same as for Event Input Assignment 1.	
C3 (83)	001A	Number of Multi-SP Points	H'00000001 (1): OFF H'00000002 to H'00000008 (2 to 8)	Advanced function setting
C3 (83)	001B	SP Ramp Time Unit	H'00000000 (0): EU/second H'00000001 (1): EU/minute H'00000002 (2): EU/hour	
C3 (83)	001D	Standby Sequence Reset	H'00000000 (0): Condition A H'00000001 (1): Condition B	
C3 (83)	001E	Auxiliary Output 1 Open in Alarm	H'00000000 (0): Close in alarm H'00000001 (1): Open in alarm	
C3 (83)	001F	Alarm 1 Hysteresis	H'00000001 to H'0000270F (0.1 to 999.9 for temperature input) (0.01 to 99.99 for analog input)	Initial setting

\*1 PRST (program start) can be set even when the program pattern is set to OFF, but the function will be disabled.

\*2 Selection is possible only if there is a remote SP input.

\*3 Selection is possible only if external communications is supported.

Variable type	Address	Parameter name	Setting (monitor) value	Level
C3 (83)	0020	Auxiliary Output 2 Open in Alarm	H'00000000 (0): Close in alarm H'00000001 (1): Open in alarm	Advanced function setting
C3 (83)	0021	Alarm 2 Hysteresis	H'00000001 to H'0000270F (0.1 to 999.9 for temperature input) (0.01 to 99.99 for analog input)	Initial setting
C3 (83)	0022	Auxiliary Output 3 Open in Alarm	H'00000000 (0): Close in alarm H'00000001 (1): Open in alarm	Advanced function setting
C3 (83)	0023	Alarm 3 Hysteresis	H'00000001 to H'0000270F (0.1 to 999.9 for temperature input) (0.01 to 99.99 for analog input)	Initial setting
C3 (83)	0024	HB ON/OFF	H'00000000 (0): OFF H'00000001 (1): ON	Advanced function setting
C3 (83)	0025	Heater Burnout Latch	H'00000000 (0): OFF H'00000001 (1): ON	
C3 (83)	0026	Heater Burnout Hysteresis	H'00000001 to H'000001F4 (0.1 to 50.0)	
C3 (83)	0027	ST Stable Range	H'00000001 to H'0000270F (0.1 to 999.9)	
C3 (83)	0028	$\alpha$	H'00000000 to H'00000064 (0.00 to 1.00)	
C3 (83)	002B	Input Digital Filter	H'00000000 to H'0000270F (0.0 to 999.9)	
C3 (83)	002C	PV/SP No. 2 Display Selection	H'00000000 (0): Nothing displayed. H'00000001 (1): PV/SP H'00000002 (2): PV H'00000003 (3): PV/SP (character display) H'00000004 (4): PV/SP/MV H'00000005 (5): PV/SP/Multi-SP No. H'00000006 (6): PV/SP/Soak time remain H'00000007 (7): PV/SP/Internal SP (ramp SP) H'00000008 (8): PV/SP/Alarm value 1	
C3 (83)	002D	MV Display	H'00000000 (0): OFF H'00000001 (1): ON	
C3 (83)	002E	Automatic Display Return Time	H'00000000 (0): OFF H'00000001 to H'00000063 (1 to 99)	
C3 (83)	002F	Alarm 1 Latch	H'00000000 (0): OFF H'00000001 (1): ON	
C3 (83)	0030	Alarm 2 Latch	H'00000000 (0): OFF H'00000001 (1): ON	
C3 (83)	0031	Alarm 3 Latch	H'00000000 (0): OFF H'00000001 (1): ON	
C3 (83)	0032	Move to Protect Level Time	H'00000001 to H'0000001E (1 to 30)	
C3 (83)	0033	Integrated Alarm Assignment	H'00000000 to H'000000FF (0 to 255)	
C3 (83)	0034	Cold Junction Compensation Method	H'00000000 (0): OFF H'00000001 (1): ON	

Note: The alarm function can also be used in Digital Temperature Controllers that do not have any auxiliary outputs. In this case, confirm alarm occurrences via the status data.

Variable type	Address	Parameter name	Setting (monitor) value	Level
C3 (83)	0038	Alarm 1 ON Delay	H'00000000 to H'000003E7 (0 to 999)	Advanced function setting
C3 (83)	0039	Alarm 2 ON Delay	H'00000000 to H'000003E7 (0 to 999)	
C3 (83)	003A	Alarm 3 ON Delay	H'00000000 to H'000003E7 (0 to 999)	
C3 (83)	003B	Alarm 1 OFF Delay	H'00000000 to H'000003E7 (0 to 999)	
C3 (83)	003C	Alarm 2 OFF Delay	H'00000000 to H'000003E7 (0 to 999)	
C3 (83)	003D	Alarm 3 OFF Delay	H'00000000 to H'000003E7 (0 to 999)	
C3 (83)	003E	Transfer Output Type	H'00000000 (0): OFF H'00000001 (1): Set point H'00000002 (2): Set point during SP ramp H'00000003 (3): PV H'00000004 (4): MV (heating) H'00000005 (5): MV (cooling) H'00000006 (6): Valve opening* * Only for Position-proportional Models.	Initial setting
C3 (83)	003F	Transfer Output Upper Limit	H'FFFFFF831 to H'0000270F (–1999 to 9999) <sup>*1</sup>	
C3 (83)	0040	Transfer Output Lower Limit	H'FFFFFF831 to H'0000270F (–1999 to 9999) <sup>*1</sup>	
C3 (83)	0041	Control Output 1 Signal	H'00000000 (0): 4 to 20 mA H'00000001 (1): 0 to 20 mA	
C3 (83)	0043	MV at Stop and Error Addition	H'00000000 (0): OFF H'00000001 (1): ON	
C3 (83)	0044	Auto/Manual Select Addition	H'00000000 (0): OFF H'00000001 (1): ON	
C3 (83)	0045	RT	H'00000000 (0): OFF H'00000001 (1): ON Note: Valid only with temperature input.	Advanced function setting
C3 (83)	0046	HS Alarm Use	H'00000000 (0): OFF H'00000001 (1): ON	
C3 (83)	0047	HS Alarm Latch	H'00000000 (0): OFF H'00000001 (1): ON	
C3 (83)	0048	HS Alarm Hysteresis	H'00000001 to H'000001F4 (0.1 to 50.0)	
C3 (83)	0049	LBA Detection Time	H'00000000 to H'0000270F (0 to 9999)	
C3 (83)	004A	LBA Level	H'00000001 to H'0000270F (0.1 to 999.9 for temperature input) (0.01 to 99.99 for analog input)	
C3 (83)	004B	LBA Band	H'00000000 to H'0000270F (0.0 to 999.9 for temperature input) (0.00 to 99.99 for analog input)	Communications setting
C3 (83)	004C	Protocol Setting <sup>*2</sup>	H'00000000 (0): CompoWay/F H'00000001 (1): Modbus H'00000002 (2): Component communications H'00000003 (3): Host Link (FINS) H'00000004 (4): MC protocol (Format 4) H'00000005 (5): Dedicated protocol (Format 4)	
C3 (83)	004D	Send Data Wait Time <sup>*2</sup>	H'00000000 to H'00000063 (0 to 99)	

\*1 The setting (monitor) range depends on the transfer output type setting. (Refer to *Section 5 Parameters* in the *E5□C Digital Temperature Controllers User's Manual* (Cat. No. H174).)

\*2 After communications parameters have been changed, reset the Digital Controller to enable them.

Variable type	Address	Parameter name	Setting (monitor) value	Level
C3 (83)	004E	Control Output 1 Assignment	<p>Control output 1 is a relay output or voltage output (for driving SSR):</p> <p>H'00000000 (0): Not assigned.  H'00000001 (1): Control output (heating)  H'00000002 (2): Control output (cooling)  H'00000003 (3): Alarm 1  H'00000004 (4): Alarm 2  H'00000005 (5): Alarm 3  H'00000006 (6): Alarm 4  H'00000007 (7): Heater alarm  H'00000008 (8): HB alarm  H'00000009 (9): HS alarm  H'0000000A (10): Input error  H'0000000B (11): RSP input error  H'0000000C (12): Program end output<sup>*1</sup>  H'0000000D (13): RUN output  H'0000000E (14): Integrated alarm  H'0000000F (15): Work bit 1  H'00000010 (16): Work bit 2  H'00000011 (17): Work bit 3  H'00000012 (18): Work bit 4  H'00000013 (19): Work bit 5  H'00000014 (20): Work bit 6  H'00000015 (21): Work bit 7  H'00000016 (22): Work bit 8</p> <p>When control output 1 is a linear current output:</p> <p>H'FFFFFFFB (-5): Simple transfer MV (cooling)<sup>*2</sup>  H'FFFFFFFC (-4): Simple transfer MV (heating)<sup>*2</sup>  H'FFFFFFFD (-3): Simple transfer PV<sup>*2</sup>  H'FFFFFFFE (-2): Simple transfer ramp SP<sup>*2</sup>  H'FFFFFFF (-1): Simple transfer SP<sup>*2</sup>  H'00000000 (0): Not assigned.  H'00000001 (1): Control output (heating)  H'00000002 (2): Control output (cooling)</p>	Advanced function setting
C3 (83)	004F	Control Output 2 Assignment	<p>Control output 2 is a relay output or voltage output (for driving SSR):</p> <p>H'00000000 to H'00000016 (0 to 22)</p> <p>* Same as for the Control Output 1 Assignment parameter.</p> <p>When control output 2 is a linear current output:</p> <p>H'00000000 to H'00000002 (0 to 2)</p> <p>* *Same as for the Control Output 1 Assignment parameter, except for items marked with “*2.”</p>	

\*1 P.END (program end output) can be set even when the program pattern is set to OFF, but the function will be disabled.

\*2 Selection is possible only with the E5CC-U and E5GC and only when there is a control output that is a linear current output. (For the E5CC-U, the Controller must have been manufactured in May 2014 or later (version 2.2).)

Variable type	Address	Parameter name	Setting (monitor) value	Level
C3 (83)	0050	Auxiliary Output 1 Assignment	H'00000000 (0): Not assigned. H'00000001 (1): Control output (heating) H'00000002 (2): Control output (cooling) H'00000003 (3): Alarm 1 H'00000004 (4): Alarm 2 H'00000005 (5): Alarm 3 H'00000006 (6): Alarm 4 H'00000007 (7): Heater alarm H'00000008 (8): HB alarm H'00000009 (9): HS alarm H'0000000A (10): Input error H'0000000B (11): RSP input error H'0000000C (12): Program end output H'0000000D (13): RUN output H'0000000E (14): Integrated alarm H'0000000F (15): Work bit 1 H'00000010 (16): Work bit 2 H'00000011 (17): Work bit 3 H'00000012 (18): Work bit 4 H'00000013 (19): Work bit 5 H'00000014 (20): Work bit 6 H'00000015 (21): Work bit 7 H'00000016 (22): Work bit 8	Advanced function setting
C3 (83)	0051	Auxiliary Output 2 Assignment	H'00000000 to H'00000016 (0 to 22) Note: Same as for the Auxiliary Output 1 Assignment parameter.	
C3 (83)	0053	Program Pattern	H'00000000 (0): OFF H'00000001 (1): STOP H'00000002 (2): CONT	Initial setting
C3 (83)	0054	Soak Time Unit	H'00000000 (0): Minutes H'00000001 (1): Hours H'00000002 (2): Seconds <sup>*1</sup>	Advanced function setting
C3 (83)	0055	Alarm SP Selection	H'00000000 (0): Set point during SP ramp H'00000001 (1): Set point	
C3 (83)	0056	Auxiliary Output 3 Assignment	H'00000000 to H'00000016 (0 to 22) Note: Same as for the Auxiliary Output 1 Assignment parameter.	
C3 (83)	0057	Close/Floating	H'00000000 (0): Floating H'00000001 (1): Close	Initial setting
C3 (83)	0058	Travel Time	H'00000001 to H'000003E7 (1 to 999)	

\*1 Selection is possible only with the E5GC.

Variable type	Address	Parameter name	Setting (monitor) value	Level	
C3 (83)	0059	PV Dead Band	H'00000000 to H'0000270F (0 to 9999)	Advanced function setting	
C3 (83)	005B	Manual MV Limit Enable	H'00000000 (0): OFF H'00000001 (1): ON		
C3 (83)	005C	Direct Setting of Position Proportional MV	H'00000000 (0): OFF H'00000001 (1): ON		
C3 (83)	005D	AT Calculated Gain	H'00000001 to H'00000064 (0.1 to 10.0)		
C3 (83)	005E	AT Hysteresis	H'00000001 to H'0000270F (0.1 to 999.9 for temperature input) (0.01 to 9.99 for analog input)		
C3 (83)	005F	Limit Cycle MV Amplitude	H'00000032 to H'000001F4 (5.0 to 50.0)		
C3 (83)	0060	Remote SP Enable	H'00000000 (0): OFF H'00000001 (1): ON		
C3 (83)	0061	Remote SP Upper limit	Input range lower limit to Input range upper limit for temperature input Scaling lower limit to Scaling upper limit for analog input		
C3 (83)	0062	Remote SP Lower limit	Input range lower limit to Input range upper limit for temperature input Scaling lower limit to Scaling upper limit for analog input		Advanced function setting
C3 (83)	0063	SP Tracking	H'00000000 (0): OFF H'00000001 (1): ON		
C3 (83)	0067	PV Rate of Change Calculation Period	H'00000001 to H'000003E7 (1 to 999)	Initial setting	
C3 (83)	0068	Heating/Cooling Tuning Method	H'00000000 (0): Same (Same as for heating.) H'00000001 (1): Linear H'00000002 (2): Air cooling H'00000003 (3): Water cooling		
C3 (83)	006C	Extraction of Square Root Enable	H'00000000 (0): OFF H'00000001 (1): ON		



Variable type	Address	Parameter name	Setting (monitor) value	Level
C3 (83)	006D	PF Setting	H'00000000 (0): Disabled. H'00000001 (1): Run H'00000002 (2): Stop H'00000003 (3): RUN/STOP H'00000004 (4): 100% AT execute H'00000005 (5): 40% AT execute H'00000006 (6): Alarm latch cancel H'00000007 (7): Auto/manual switch H'00000008 (8): Monitor/setting item H'00000009 (9): Digit shift key	Advanced function setting
C3 (83)	006E	Monitor/Setting Item 1	H'00000000 (0): Disabled H'00000001 (1): PV/SP/Multi-SP H'00000002 (2): PV/SP/MV H'00000003 (3): PV/SP/soak time remain H'00000004 (4): Proportional band H'00000005 (5): Integral time H'00000006 (6): Derivative time H'00000007 (7): Alarm value 1 H'00000008 (8): Alarm value upper limit 1 H'00000009 (9): Alarm value lower limit 1 H'0000000A (10): Alarm value 2 H'0000000B (11): Alarm value upper limit 2 H'0000000C (12): Alarm value lower limit 2 H'0000000D (13): Alarm value 3 H'0000000E (14): Alarm value upper limit 3 H'0000000F (15): Alarm value lower limit 3 H'00000010 (16): Alarm value 4 H'00000011 (17): Alarm value upper limit 4 H'00000012 (18): Alarm value lower limit 4 H'00000013 (19): PV/SP/Internal set point H'00000014 (20): PV/SP/Alarm value 1 H'00000015 (21): Proportional band (cooling) H'00000016 (22): Integral time (cooling) H'00000017 (23): Derivative time (cooling)	
C3 (83)	006F	Monitor/Setting Item 2	H'00000000 to H'00000017 (0 to 23) Note: Same as for Monitor/Setting Item 1.	
C3 (83)	0070	Monitor/Setting Item 3	H'00000000 to H'00000017 (0 to 23) Note: Same as for Monitor/Setting Item 1.	
C3 (83)	0071	Monitor/Setting Item 4	H'00000000 to H'00000017 (0 to 23) Note: Same as for Monitor/Setting Item 1.	
C3 (83)	0072	Monitor/Setting Item 5	H'00000000 to H'00000017 (0 to 23) Note: Same as for Monitor/Setting Item 1.	

Variable type	Address	Parameter name	Setting (monitor) value	Level
C3 (83)	0073	PV/SP No. 1 Display Selection	H'00000000 (0): Nothing displayed. H'00000001 (1): PV/SP H'00000002 (2): PV H'00000003 (3): PV/SP (character display) H'00000004 (4): PV/SP/MV H'00000005 (5): PV/SP/Multi-SP No. H'00000006 (6): PV/SP/Soak time remain H'00000007 (7): PV/SP/Internal SP (ramp SP) H'00000008 (8): PV/SP/Alarm value 1	Advanced function setting
C3 (83)	0074	MV Display Selection	H'00000000 (0): MV (heating) H'00000001 (1): MV (cooling)	
C3 (83)	0075	PV Decimal Point Display	H'00000000 (0): OFF H'00000001 (1): ON	
C3 (83)	0076	PV Status Display Function	H'00000000 (0): OFF H'00000001 (1): Manual H'00000002 (2): Stop H'00000003 (3): Alarm 1 H'00000004 (4): Alarm 2 H'00000005 (5): Alarm 3 H'00000006 (6): Alarm 4 H'00000007 (7): Alarm 1 to 4 OR status H'00000008 (8): Heater alarm H'00000009 (9): Status display message <sup>*1</sup>	
C3 (83)	0077	SV Status Display Function	H'00000000 to H'00000009 (0 to 9) Note: Same as for PV Status Display Function	
C3 (83)	0083	Display Refresh Period	H'00000000 (0): OFF H'00000001 (1): 0.25 H'00000002 (2): 0.5 H'00000003 (3): 1.0	
C3 (83)	0084	Alarm 4 Type	H'00000000 to H'00000013 (0 to 19) Note: Same settings as the Alarm 1 Type. However, the LBA (loop burnout alarm) cannot be set.	Initial setting
C3 (83)	0085	Event Input Assignment 5	H'00000000 to H'0000000D (0 to 13) Note: Same as for Event Input Assignment 1.	
C3 (83)	0086	Event Input Assignment 6	H'00000000 to H'0000000D (0 to 13) Note: Same as for Event Input Assignment 1.	
C3 (83)	0087	Auxiliary Output 4 Open in Alarm	H'00000000 (0): Close in alarm H'00000001 (1): Open in alarm	Advanced function setting
C3 (83)	0088	Alarm 4 Hysteresis	H'00000001 to H'0000270F (0.1 to 999.9 for temperature input) (0.01 to 99.99 for analog input)	Initial setting
C3 (83)	0089	Moving Average Count	H'00000000 (0): OFF H'00000001 (1): 2 times H'00000002 (2): 4 times H'00000003 (3): 8 times H'00000004 (4): 16 times H'00000005 (5): 32 times	Advanced function setting
C3 (83)	008A	Alarm 4 Latch	H'00000000 (0): OFF H'00000001 (1): ON	
C3 (83)	008B	Alarm 4 ON delay	H'00000000 to H'000003E7 (0 to 999)	
C3 (83)	008C	Alarm 4 OFF delay	H'00000000 to H'000003E7 (0 to 999)	

\*1 Selection is possible only with the E5GC.

Variable type	Address	Parameter name	Setting (monitor) value	Level
C3 (83)	008D	Control Output 2 Signal	H'00000000 (0): 4 to 20 mA H'00000001 (1): 0 to 20 mA	Initial setting
C3 (83)	008E	Transfer Output Signal	H'00000000 (0): 4 to 20 mA H'00000001 (1): 1 to 5 V	
C3 (83)	008F	Auxiliary Output 4 Assignment	H'00000000 to H'00000016 (0 to 22) Note: Same as for the Auxiliary Output 1 Assignment parameter.	Advanced function setting
C3 (83)	0090	Remote SP Input	H'00000000 (0): 4 to 20 mA H'00000001 (1): 0 to 20 mA H'00000002 (2): 1 to 5 V H'00000003 (3): 0 to 5 V H'00000004 (4): 0 to 10 V	
C3 (83)	0091	Integral/Derivative Time Unit	H'00000000 (0): 1 s H'00000001 (1): 0.1 s	
C3 (83)	0092	Manual Output Method	H'00000000 (0): HOLD H'00000001 (1): INIT	
C3 (83)	0093	Manual MV Initial Value	Standard control or close position-proportional control: H'FFFFFFCE to H'0000041A (–5.0 to 105.0) Heating and cooling control: H'FFFFFFBE6 to H'0000041A (–105.0 to 105.0)	
C3 (83)	0094	Minimum Output ON/OFF Band	H'00000000 to H'000001F4 (0 to 50.0)	
C3 (83)	0095	Display Brightness	H'00000001 to H'00000003 (1 to 3)	

Variable type	Address	Parameter name	Setting (monitor) value	Level
C3 (83)	0096	Highest Communications Unit No.	H'00000000 to H'00000063 (0 to 99)	Communications setting
C3 (83)	0097	Area	<ul style="list-style-type: none"> <li>When Protocol Setting Parameter Is Set to FINS  H'00000000 (0): DM  H'00000001 (1): EM0  H'00000002 (2): EM1  H'00000003 (3): EM2  H'00000004 (4): EM3  H'00000005 (5): EM4  H'00000006 (6): EM5  H'00000007 (7): EM6  H'00000008 (8): EM7  H'00000009 (9): EM8  H'0000000A (10): EM9  H'0000000B (11): EMA  H'0000000C (12): EMB  H'0000000D (13): EMC  H'0000000E (14): EMD  H'0000000F (15): EME  H'00000010 (16): EMF  H'00000011 (17): EM10  H'00000012 (18): EM11  H'00000013 (19): EM12  H'00000014 (20): EM13  H'00000015 (21): EM14  H'00000016 (22): EM15  H'00000017 (23): EM16  H'00000018 (24): EM17  H'00000019 (25): EM18</li> <li>When Protocol Setting Parameter Is Set to MCP4  H'00000000 (0): D data registers  H'00000001 (1): W link registers  H'00000002 (2): R file registers  H'00000003 (3): ZR file registers  Any other value specifies D data registers.</li> <li>When Protocol Setting Parameter Is Set to FXP4  H'00000000 (0): D data registers or DM data memory registers  H'00000001 (1): None or W link registers  H'00000002 (2): R expansion registers or FM file registers  Do not use any other values.</li> </ul>	
C3 (83)	0098	First Address Upper Word	H'00000000 to H'00000063 (0 to 99)	
C3 (83)	0099	First Address Lower Word	H'00000000 to H'0000270F (0 to 9999)	
C3 (83)	009A	Receive Data Wait Time	H'00000064 to H'0000270F (100 to 9999)	

Variable type	Address	Parameter name	Setting (monitor) value	Level
C3 (83)	009B	Communications Node Number	H'00000000 to H'00000063 (0 to 99)	Communications setting
C3 (83)	009C	Upload Setting 1	H'00000000 to H'00000062 (0 to 98)	
C3 (83)	009D	Upload Setting 2	H'00000000 to H'00000062 (0 to 98)	
C3 (83)	009E	Upload Setting 3	H'00000000 to H'00000062 (0 to 98)	
C3 (83)	009F	Upload Setting 4	H'00000000 to H'00000062 (0 to 98)	
C3 (83)	00A0	Upload Setting 5	H'00000000 to H'00000062 (0 to 98)	
C3 (83)	00A1	Upload Setting 6	H'00000000 to H'00000062 (0 to 98)	
C3 (83)	00A2	Upload Setting 7	H'00000000 to H'00000062 (0 to 98)	
C3 (83)	00A3	Upload Setting 8	H'00000000 to H'00000062 (0 to 98)	
C3 (83)	00A4	Upload Setting 9	H'00000000 to H'00000062 (0 to 98)	
C3 (83)	00A5	Upload Setting 10	H'00000000 to H'00000062 (0 to 98)	
C3 (83)	00A6	Upload Setting 11	H'00000000 to H'00000062 (0 to 98)	
C3 (83)	00A7	Upload Setting 12	H'00000000 to H'00000062 (0 to 98)	
C3 (83)	00A8	Upload Setting 13	H'00000000 to H'00000062 (0 to 98)	
C3 (83)	00A9	Download Setting 1	H'0000001E to H'00000062 (30 to 98)	
C3 (83)	00AA	Download Setting 2	H'0000001E to H'00000062 (30 to 98)	
C3 (83)	00AB	Download Setting 3	H'0000001E to H'00000062 (30 to 98)	
C3 (83)	00AC	Download Setting 4	H'0000001E to H'00000062 (30 to 98)	
C3 (83)	00AD	Download Setting 5	H'0000001E to H'00000062 (30 to 98)	
C3 (83)	00AE	Download Setting 6	H'0000001E to H'00000062 (30 to 98)	
C3 (83)	00AF	Download Setting 7	H'0000001E to H'00000062 (30 to 98)	
C3 (83)	00B0	Download Setting 8	H'0000001E to H'00000062 (30 to 98)	
C3 (83)	00B1	Download Setting 9	H'0000001E to H'00000062 (30 to 98)	
C3 (83)	00B2	Download Setting 10	H'0000001E to H'00000062 (30 to 98)	
C3 (83)	00B3	Download Setting 11	H'0000001E to H'00000062 (30 to 98)	
C3 (83)	00B4	Download Setting 12	H'0000001E to H'00000062 (30 to 98)	
C3 (83)	00B5	Download Setting 13	H'0000001E to H'00000062 (30 to 98)	
C3 (83)	00B6	SP Slope	H'00000001 to H'0000270F (0.001 to 9.999)	
C3 (83)	00B7	SP Offset	H'FFFFFF831 to H'0000270F (-199.9 to 999.9: Input type = Temperature input) (-1999 to 9999: Input type = Analog input)	
C3 (83)	00B8	LCT Cooling Output Minimum ON Time (Not supported on version 2.0 or earlier of the E5CC, E5EC, or E5AC.)	H'00000001 to H'0000000A (0.1 to 1.0)	Advanced function setting
C3 (83)	00CA	Simple Transfer Output 1 Upper Limit	H'FFFFFF831 to H'0000270F (-1999 to 9999)*1	Initial setting
C3 (83)	00CB	Simple Transfer Output 1 Lower Limit	H'FFFFFF831 to H'0000270F (-1999 to 9999)*1	

\*1 Selection is possible only with the E5CC-U and E5GC and only when there is a control output that is a linear current output. (For the E5CC-U, the Controller must have been manufactured in May 2014 or later (version 2.2).)

## 3-2 Status and Status 2

The figure below shows the structure of the status data.

### ● Status Structure

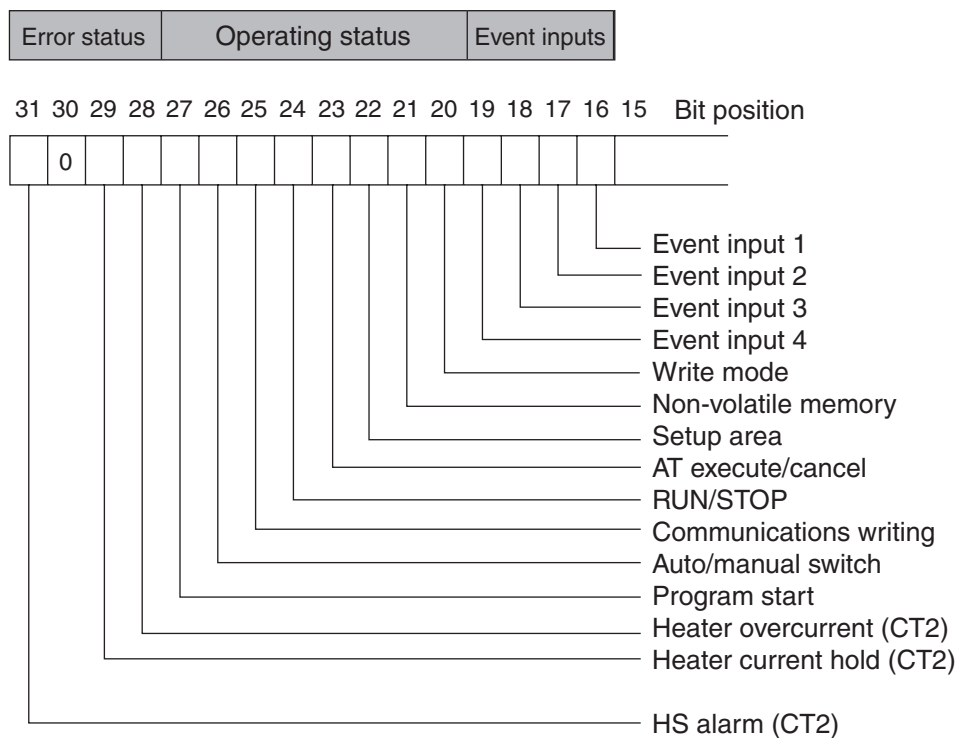
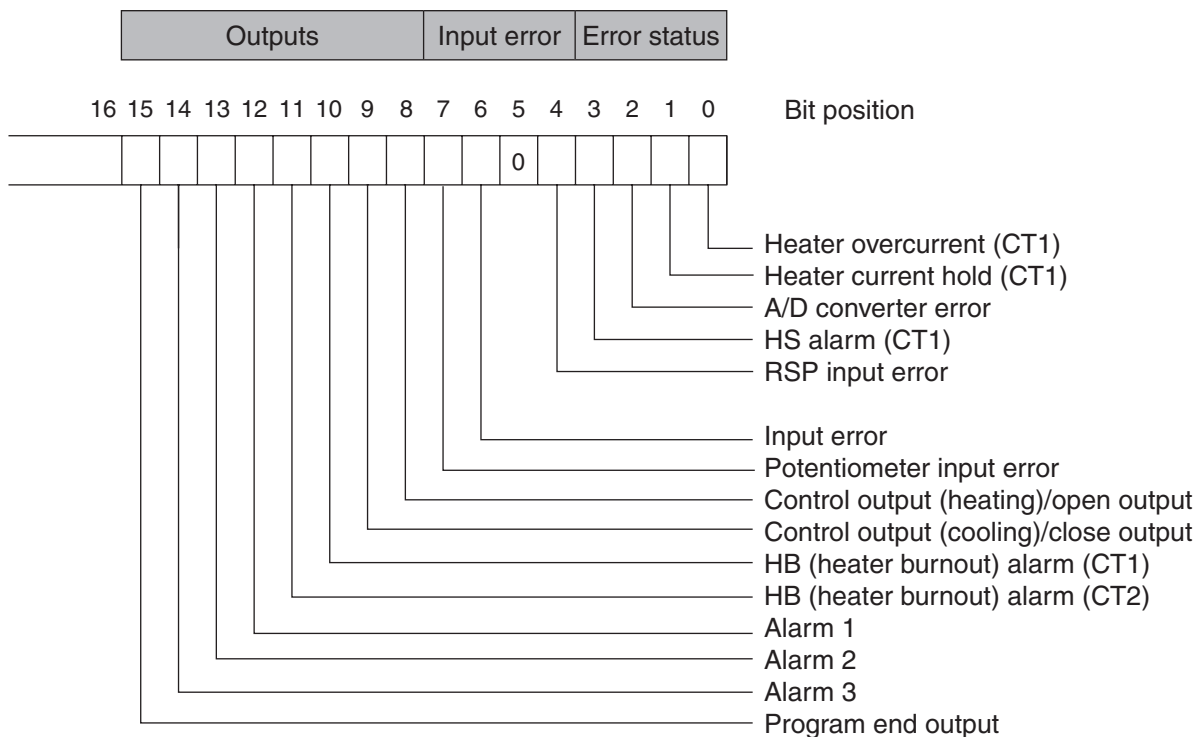

● Status 2 Structure

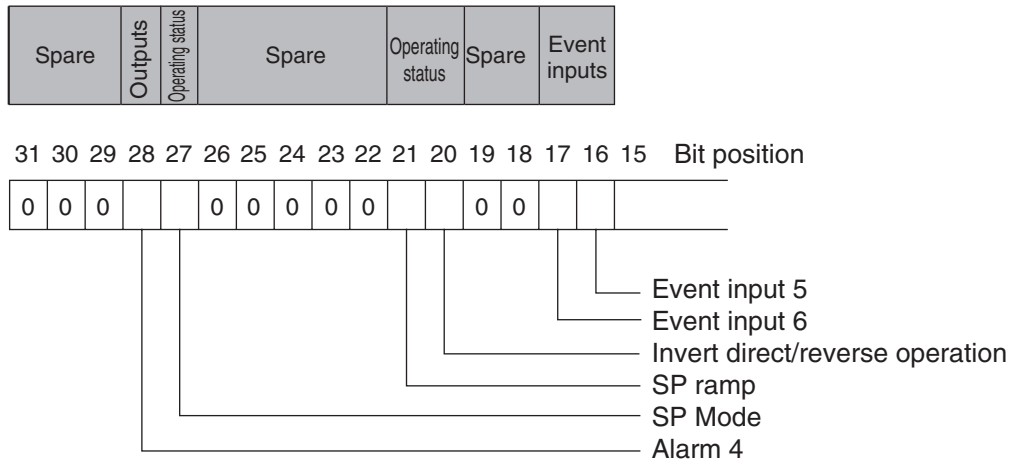
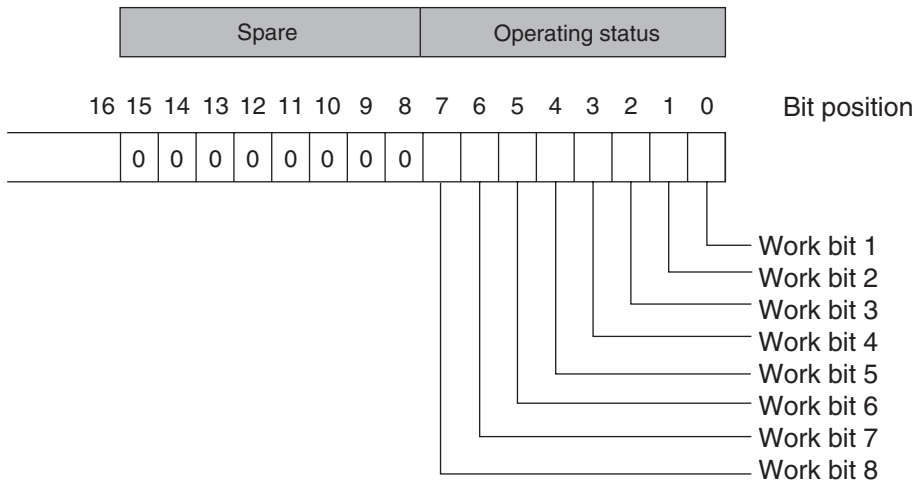

## ● Status Details

Bit position	Status	Bit Description		
		0	1	
Status (lower word)	0	Heater overcurrent (CT1)	Not generated	Generated
	1	Heater current hold (CT1)*	Update	Hold
	2	A/D converter error	Not generated	Generated
	3	HS alarm (CT1)	OFF	ON
	4	RSP input error	Not generated	Generated
	5	Spare	OFF	---
	6	Input error	Not generated	Generated
	7	Potentiometer input error	Not generated	Generated
	8	Control output (heating)/open output	OFF	ON
	9	Control output (cooling)/close output	OFF	ON
	10	HB (heater burnout) alarm (CT1)	OFF	ON
	11	HB (heater burnout) alarm (CT2)	OFF	ON
	12	Alarm 1	OFF	ON
	13	Alarm 2	OFF	ON
	14	Alarm 3	OFF	ON
Status (upper word)	15	Program end output	OFF	ON
	16	Event input 1	OFF	ON
	17	Event input 2	OFF	ON
	18	Event input 3	OFF	ON
	19	Event input 4	OFF	ON
	20	Write mode	Backup mode	RAM write mode
	21	Non-volatile memory	RAM = Non-volatile memory	RAM ≠ Non-volatile memory
	22	Setup area	Setup area 0	Setup area 1
	23	AT execute/cancel	AT canceled	AT execution in progress
	24	RUN/STOP	Run	Stop
	25	Communications writing	OFF (disabled)	ON (enabled)
	26	Auto/manual switch	Automatic mode	Manual mode
	27	Program start	Reset	Start
	28	Heater overcurrent (CT2)	Not generated	Generated
	29	Heater current hold (CT2)	Update	Hold
	30	Spare	OFF	---
	31	HS alarm (CT2)	OFF	ON

Note 1 "Spare" bits are always OFF.

2 When read in setup area 1, the status of the bits will be as follows:

- Overcurrent: Last value held
- A/D converter error: Last value held
- Input error: Last value held
- HB and HS outputs: Cleared
- Program end output: Cleared
- Current hold: Last value held
- Heating and cooling outputs: Cleared
- Alarm outputs: Cleared

\* When the control output ON time is less than 30 ms for a control period of 0.1 s or 0.2 s or when it is less than 100 ms for any other control period, the bit is set to "1" and the heater current is held at the last current value.



## ● Status 2 Details

Bit position	Status	Bit Description		
		0	1	
Status (lower word)	0	Work bit 1	OFF	ON
	1	Work bit 2	OFF	ON
	2	Work bit 3	OFF	ON
	3	Work bit 4	OFF	ON
	4	Work bit 5	OFF	ON
	5	Work bit 6	OFF	ON
	6	Work bit 7	OFF	ON
	7	Work bit 8	OFF	ON
	8	Spare	OFF	---
	9	Spare	OFF	---
	10	Spare	OFF	---
	11	Spare	OFF	---
	12	Spare	OFF	---
	13	Spare	OFF	---
	14	Spare	OFF	---
15	Spare	OFF	---	
Status (upper word)	16	Event input 5	OFF	ON
	17	Event input 6	OFF	ON
	18	Spare	OFF	---
	19	Spare	OFF	---
	20	Invert direct/reverse operation	Not invert	Invert
	21	SP ramp	OFF	During SP ramp
	22	Spare	OFF	---
	23	Spare	OFF	---
	24	Spare	OFF	---
	25	Spare	OFF	---
	26	Spare	OFF	---
	27	SP Mode	Local SP Mode	Remote SP Mode
	28	Alarm 4	OFF	ON
	29	Spare	OFF	---
	30	Spare	OFF	---
	31	Spare	OFF	---

Note 1 "Spare" bits are always OFF.

2 When read in setup area 1, the status of the bits will be as follows:

- Work bits 1 to 8: Cleared
- SP ramp: Last value held



# 4

## Modbus Communications Procedure

Read this section if you are to communicate using the Modbus format.

---

<b>4-1 Data Format</b>	<b>4-2</b>
4-1-1 Command Frame	4-2
4-1-2 Response Frame	4-4
4-1-3 Error Codes	4-5
<b>4-2 Function List</b>	<b>4-6</b>
<b>4-3 Variable Area</b>	<b>4-7</b>
<b>4-4 Detailed Description of the Functions</b>	<b>4-8</b>
4-4-1 Variable Read, Multiple	4-8
4-4-2 Variable Write, Multiple	4-10
4-4-3 Variable Write, Single/Operation Command	4-12
4-4-4 Echoback Test	4-15

## 4-1 Data Format

The data format complies with the Modbus (RTU) communications protocol, so commands from the host and responses from the E5□C are contained in data blocks called frames.

The structure of the command and response frames is described below.

In the following explanations, hexadecimal values are expressed by adding the prefix H' before the number, e.g., H'02. Numbers and alphabetic characters without the H' prefix are ASCII characters.

### 4-1-1 Command Frame

When using RTU mode, start with a silent interval of at least 3.5 character times and end with a silent interval of at least 3.5 character times.

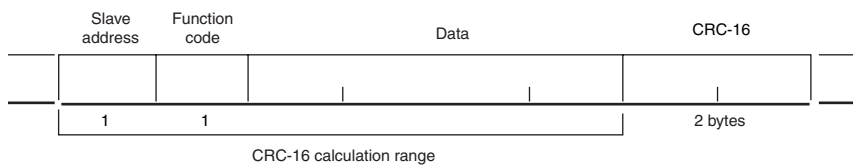

	Silent interval of 3.5 character times minimum.
<b>Slave address</b>	Specify the unit number. The unit number can be set between H'00 to H'63 hexadecimal (0 to 99 decimal). Specify H'00 for a broadcast transmission. No responses will be returned for broadcast transmissions.
<b>Function code</b>	The function code is a 1-byte hexadecimal code that indicates the type of command sent from the host device.
<b>Data</b>	This is the text data associated with the specified function code. Specify the required data, such as the variable address or setting data. (Set in hexadecimal.)
<b>CRC-16</b>	Cyclic Redundancy Check This check code is calculated with the data from the slave address to the end of the data. The check code is 2-byte hexadecimal.
	Silent interval of 3.5 character times minimum.

● **CRC-16 Calculation Example**

Messages are processed one byte at a time in the work memory (a 16-bit register known as the CRC register).

- (1) The CRC register is initialized to H'FFFF.
- (2) An XOR operation is performed on the content of the CRC register and the first byte of the message, and the result is returned to the CRC register.
- (3) The MSB is packed with zeroes and the CRC register is shifted 1 bit to the right.
- (4) If the bit shifted from the LSB is 0, step 3 is repeated (next bit-shift processing).  
If the bit shifted from the LSB is 1, an XOR is performed on the content of the CRC register and H'A001, and the result is returned to the CRC register.
- (5) Steps 3 and 4 are repeated until 8 bits are shifted.
- (6) CRC processing continues to the end of the message, as XOR operations are performed on the content of the CRC register and the next byte of the message, step 3 is repeated, and the result is returned to the CRC register.
- (7) The result of the CRC calculation (value in the CRC register) is appended to the last byte of the message.

● **Example of Appending the Calculation Result**

When the calculated CRC value is H'1234, the CRC value is appended to the command frame as follows.

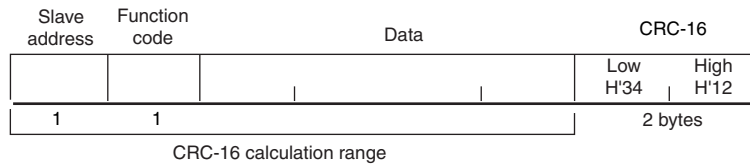

### 4-1-2 Response Frame

● **Normal Response Frame**

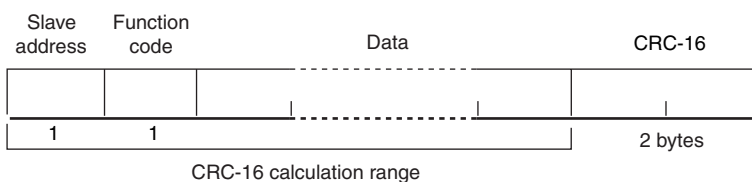

● **Error Response Frame**

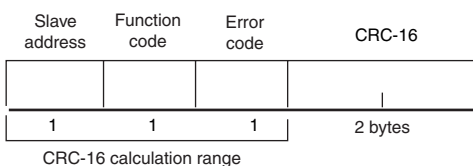

<b>Slave address</b>	The number specified in the command frame is entered as-is. This is the unit number of the Unit returning the response.
<b>Function code</b>	This is the received function code with the hexadecimal value of H'80 added to indicate that the response is an error response. Example: Received function code = H'03 Function code in response frame when an error occurred = H'83
<b>Error code</b>	This code indicates the kind of error that occurred.
<b>CRC-16</b>	Cyclic Redundancy Check This check code is calculated with the data from the slave address to the end of the data. The check code is 2-byte hexadecimal.

### 4-1-3 Error Codes

End code	Name	Description	Error detection priority
H'01	Function code error	An unsupported function code was received.	1
H'02	Variable address error	The specified variable area address is out-of-range.	2
H'03	Variable data error	The amount of data does not match the number of elements. The byte count is not 2 times the number of elements. The response length exceeds the size of the communications buffer. The command code or related information in the operation command is wrong or the write data is not in the setting range.	3
H'04	Operation error	The write data contents are not allowed in the present operation mode. <ul style="list-style-type: none"> <li>• The Communications Writing parameter is set to "OFF" (disabled).</li> <li>• Attempted to write to a parameter in setup area 1 from setup area 0.</li> <li>• Attempted to write to a protect parameter from other than the protect level.</li> <li>• AT execution is in progress.</li> <li>• The command cannot be processed.</li> </ul>	4

#### ● No Response

In the following cases, the received command will not be processed and a response will not be returned.

Consequently, a timeout error will occur at the host device.

- The slave address in the received command does not match the communications unit number.
- A parity error, framing error, or overrun error occurred due to a problem such as a transfer error.
- A CRC-16 code error occurred in the received command frame.
- There was a time interval of more than 3.5 character times between data packets that make up the command frame.

Furthermore, the specified function's processing will be performed but no response will be returned for broadcast functions (slave address = H'00).

## 4-2 Function List

---

The following table lists the function codes.

### Function Code List

Function code	Name	Process
03 (H'03)	Read variable (multiple)	This function reads from the variable area. It is possible to read two or more consecutive variables.
16 (H'10)	Write variable (multiple)	This function writes to the variable area. It is possible to write two or more consecutive variables. It is also possible to broadcast this function (broadcast transmission).
06 (H'06)	Write variable (Single/operation command)	This function writes to the variable area and writes operation commands. It is also possible to write to a single parameter by specifying the address in 2-byte mode. (This is not supported in 4-byte mode.) It is also possible to broadcast this function (broadcast transmission.)
08 (H'08)	Echoback Test	This function performs an echoback test.



## 4-3 Variable Area

The variable area is the region of memory used to exchange data with the E5□C through communications.

Operations such as reading the process value and reading/writing parameters are performed on the variable area.

On the other hand, operation commands do not use the variable area.

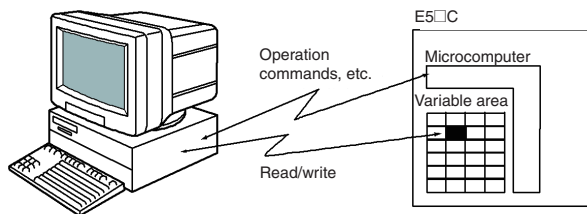

When accessing the variable area, the position of a variable in the variable area is specified with a word identifier, area number, and address in the area.

### ● Addresses

An address is appended to each of the variable types. Express addresses in 2-byte hexadecimal and append them for the specified access size.

### ● Number of Elements

The number of elements is expressed in 2-byte hexadecimal. The setting range for the number of elements varies according to the command.

### Four-byte Mode

One element uses 2 bytes of data, so specify two-element units. Reading and writing in 4-byte units is executed by specifying an even address and specifying the number of elements in multiples of 2.

### Two-byte Mode

One element uses 2 bytes of data, so specify one-element units. Reading and writing in 2-byte data units is executed by specifying 1-element units.

### ● Set Values

The values read from the variable area or written to the variable area are expressed in hexadecimal, ignoring the decimal point position. (Negative values are expressed in 2's complement format.)

Example: D'105.0 → H'000041A

The variables are 4-digit or 8-digit hexadecimal values. Negative values are expressed in 2's complement format. The values are hexadecimal values with no decimal point indication.

For example, if the E5□C's process value is read in 4-byte mode when the process value is 105.0, the read value will be H'000041A (105.0 → 1050 → H'000041A).

## 4-4 Detailed Description of the Functions

### 4-4-1 Variable Read, Multiple

To read from the variable area, set the required data in the command frame, as shown in the following diagram.

#### Command Frame

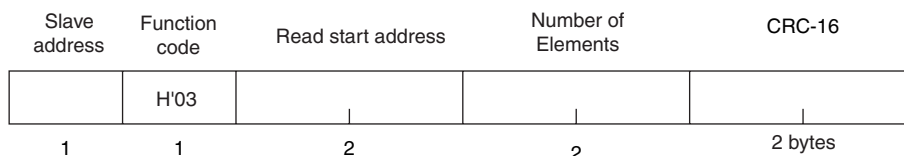

Name	Description
Slave address	Specify the E5□C's unit number. The unit number can be set between H'01 and H'63 hexadecimal (1 to 99 decimal).
Function code	The Read Variable Area function's function code is H'03.
Read start address	Specify the address containing the data to be read. Refer to <i>Section 5 Communications Data for Modbus</i> for details on addresses.
Number of elements	<p>4-byte Mode Specify 2 times the number of setting data items as the number of elements to be read. The setting range for the number of elements is H'0002 to H'006A (2 to 106). When H'006A is set, 53 items of setting data can be read. Example: When reading 2 items of setting data, set the number of elements to H'0004.</p> <p>2-byte Mode Specify the number of setting data items to be read as the number of elements. The setting range for the number of elements is H'0001 to H'006A (1 to 106). When H'006A is set, 106 items of setting data can be read. Example: When reading two items of setting data, set the number of elements to H'0002.</p>
CRC-16	This check code is calculated with the data from the slave address to the end of the data. For details on the CRC-16 calculation, refer to <i>CRC-16 Calculation Example</i> in 4-1-1 <i>Command Frame</i> on page 4-2.

### Response Frame

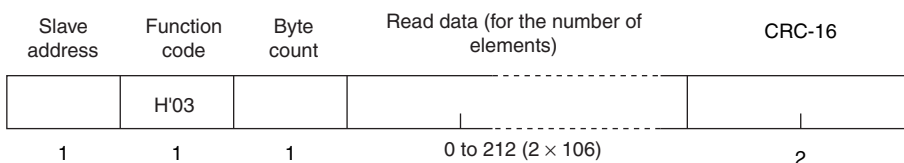

Name	Description
Slave address	The value from the command frame is entered as-is.
Function code	This is the received function code. When the function ended normally, the function code is left as-is. When an error occurred, the hexadecimal value of H'80 is added to the function code to indicate that the response is an error response. Example: Received function code = H'03 Function code in response frame when an error occurred = H'83
Byte count	Contains the number of bytes of read data.
Read data	Contains the number of setting data items that were read.
CRC-16	This check code is calculated with the data from the slave address to the end of the data. For details on the CRC-16 calculation, refer to <i>CRC-16 Calculation Example</i> in 4-1-1 <i>Command Frame</i> on page 4-2.

### Response Code

Function code	Error code	Error name	Cause
H'83	H'02	Variable address error	The read start address is incorrect.
	H'03	Variable data error	The number of elements exceeds the allowed range.
H'03	---	Normal completion	No errors were found.

### Reading Undisplayed Parameters

It is possible to read the parameters that are not displayed due to display settings as well as the parameters that are never displayed in the Controller.

- Example Command and Response

The following example shows the command and response when reading the process value (slave address: H'01).

Process Value in 4-byte Mode

- Address: H'0000; Read data: H'000003E8 (100.0 °C)

Command: 01 03 00 00 00 02 C4 0B(CRC-16)

Response: 01 03 04 00 00 03 E8 FA 8D(CRC-16)

Process Value in 2-byte Mode

- Address: H'2000; Read data: H'03E8 (100.0 °C)

Command: 01 03 20 00 00 01 8FCA(CRC-16)

Response: 01 03 02 03 E8 B8 FA(CRC-16)

### 4-4-2 Variable Write, Multiple

To write data to the variable area, set the required data in the command frame, as shown in the following diagram.

#### Command Frame

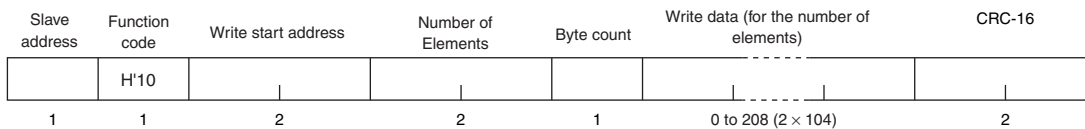

Name	Description
Slave address	Specify the E5□C's unit number. The unit number can be set between H'01 and H'63 hexadecimal (1 to 99 decimal).
Function code	The Write Variable Area function's function code is H'10.
Write start address	Specify the starting address where the setting data will be written. Refer to <i>Section 5 Communications Data for Modbus</i> for details on addresses.
Number of elements	<p>4-byte Mode</p> <p>Specify 2 times the number of setting data items as the number of elements to be written.</p> <p>The setting range for the number of elements is H'0002 to H'0068 (2 to 104). When H'0068 is set, 52 items of setting data can be read. Example: When writing 2 items of setting data, set the number of elements to H'0004.</p> <p>2-byte Mode</p> <p>Specify the number of setting data items to be written as the number of elements.</p> <p>The setting range for the number of elements is H'0001 to H'0068 (1 to 104). When H'0068 is set, 104 items of setting data can be read. Example: When reading two items of setting data, set the number of elements to H'0002.</p>
Byte count	Specify the number of bytes of write data.
CRC-16	This check code is calculated with the data from the slave address to the end of the data. For details on the CRC-16 calculation, refer to <i>CRC-16 Calculation Example</i> in 4-1-1 <i>Command Frame</i> on page 4-2.

## ● Response Frame

Slave address	Function code	Write start address	Number of Elements	CRC-16
1	H' 10	2	2	2 bytes

Name	Description
Slave address	The value from the command frame is entered as-is.
Function code	This is the received function code. When the function ended normally, the function code is left as-is. When an error occurred, the hexadecimal value of H'80 is added to the function code to indicate that the response is an error response. Example: Received function code = H'10 Function code in response frame when an error occurred = H'90
Write start address	This is the received write start address.
Number of elements	This is the received number of elements.
CRC-16	This check code is calculated with the data from the slave address to the end of the data. For details on the CRC-16 calculation, refer to <i>CRC-16 Calculation Example</i> in 4-1-1 Command Frame on page 4-2.

## Response Code

Function code	Error code	Error name	Cause
H'90	H'02	Variable address error	The write start address is incorrect.
	H'03	Variable data error	<ul style="list-style-type: none"> <li>The amount of data does not match the number of elements.</li> <li>The byte count is not 2 times the number of elements.</li> <li>The write data is out of the setting range.</li> </ul>
	H'04	Operation error	<p>The Controller cannot write the data in its present operating status.</p> <p>The write data contents are not allowed in the present operation mode.</p> <ul style="list-style-type: none"> <li>The Communications Writing parameter is set to "OFF" (disabled).</li> <li>Attempted to write to a parameter in setup area 1 from setup area 0.</li> <li>Attempted to write to a protect parameter from other than the protect level.</li> <li>AT execution is in progress.</li> </ul>
H'10	---	Normal completion	No errors were found.

**Writing Undisplayed Parameters**

It is possible to write the parameters that are not displayed due to display settings as well as the parameters that are never displayed in the Controller.

- Example Command and Response

The following example shows the command/response when writing the Alarm Value Upper Limit 1 and Alarm Value Lower Limit 1 parameters.

(In this case, the slave address is H'01.)

Four-byte Mode

Alarm Value Upper Limit 1

- Address: H'010A; Write data: H'000003E8 (when 1000)

Alarm Value Lower Limit 1

- Address: H'010C; Write data: H'FFFFFFC18 (when -1000)

Command:	01	10	01 0A	00 04	08	00 00 03 E8	FF FF FC 18	8D E9(CRC-16)
Response:	01	10	01 0A	00 04	E0 34(CRC-16)			

Two-byte Mode

Alarm Value Upper Limit 1

- Address: H'2105; Write data: H'03E8 (when 1000)

Alarm Value Lower Limit 1

- Address: H'2106; Write data: H' FC18 (when -1000)

Command:	01	10	21 05	00 02	04	03 E8	FC 18	66 BB(CRC-16)
Response:	01	10	21 05	00 02	5B F5(CRC-16)			

**4-4-3 Variable Write, Single/Operation Command**

This function performs operations such as writing to the variable area (single) and operation commands (communications writing, RUN/STOP, multi-SP, AT execute/cancel, write mode, save RAM data, software reset, move to setup area 1, move to protect level, auto/manual switch, initialize settings, alarm latch cancel, invert direct/reverse operation, program start, and SP mode.)

Writing is enabled in only the 2-byte mode.

**Command Frame**

Slave address	Function code	Write variable address	Write data	CRC-16
1	H'06	2	2	2 bytes

**Response Frame**

Slave address	Function code	Write variable address	Write data	CRC-16
1	H'06	2	2	2 bytes

**(1) Write variable address**

Specify the address of the setting data that is to be written. For details on addresses, refer to *Section 5 Modbus Communications Procedure*.

For an operation command, specify 0000 or FFFF.

## (2) Command Code and Related Information

Command code	Command content	Related information
00	Communications writing	00: OFF (disabled) 01: ON (enabled)
01	RUN/STOP	00: Run 01: Stop
02	Multi-SP	00: Set point 0 01: Set point 1 02: Set point 2 03: Set point 3 04: Set point 4 05: Set point 5 06: Set point 6 07: Set point 7
03	AT execute/cancel	00: AT cancel 01: 100% AT execute 02: 40% AT execute
04	Write mode	00: Backup 01: RAM write mode
05	Save RAM data	00
06	Software reset	00
07	Move to setup area 1	00
08	Move to protect level	00
09	Auto/manual switch	00: Automatic mode 01: Manual mode
0B	Parameter initialization	00
0C	Alarm latch cancel	00: Alarm 1 latch cancel 01: Alarm 2 latch cancel 02: Alarm 3 latch cancel 03: HB alarm latch cancel 04: HS alarm latch cancel 05: Alarm 4 latch cancel 0F: All alarm latch cancel
0D	SP Mode	00: Local SP Mode 01: Remote SP Mode
0E	Invert direct/reverse operation	00: Not invert 01: Invert
11	Program start	00: Reset 01: Start

**(3) Response Code**

- Normal Completion

Function code	Error code	Name	Description
H'06	---	Normal completion	No errors were found.

- Error Occurred

Function code	Error code	Name	Description
H'86	H'02	Variable address error	The write variable address is incorrect.
	H'03	Variable data error	The write data is incorrect. <ul style="list-style-type: none"> <li>• The write data is out of the setting range.</li> <li>• Command code or related information are incorrect.</li> </ul>
	H'04	Operation error	The Controller cannot write the data in its present operating status. <ul style="list-style-type: none"> <li>• The Communications Writing parameter is set to "OFF" (disabled). The command is received regardless of the Communications Writing parameter setting (ON/OFF).</li> <li>• Attempted to write to a parameter in setup area 1 from setup area 0.</li> <li>• Attempted to write to a protect parameter from other than the protect level.</li> <li>• AT execution is in progress.</li> <li>• The command cannot be processed. For details, refer to (5) <i>Operation Commands and Precautions</i> following this table.</li> </ul>

Note: For details on variable writing, refer to 4-4-2 *Variable Write, Multiple*. For details on AT, refer to the *E5□C Digital Temperature Controllers User's Manual Basic Type* (Cat. No. H174).

**(4) Example Command and Response**

The following example shows the command/response for a Stop command. (In this case, the slave address is H'01.)

Stop command (command code: 01; related information: 01)

- Address: H'0000 (fixed)

Write data: H'0101 (Run/Stop, Stop command)

Command: 

01	06	00 00	01 01	49 9A(CRC-16)
----	----	-------	-------	---------------

Response: 

01	06	00 00	01 01	49 9A(CRC-16)
----	----	-------	-------	---------------

**(5) Operation Commands and Precautions**

This information is the same as that for CompoWay/F. Refer to page 2-17.



## 4-4-4 Echoback Test

### Command Frame

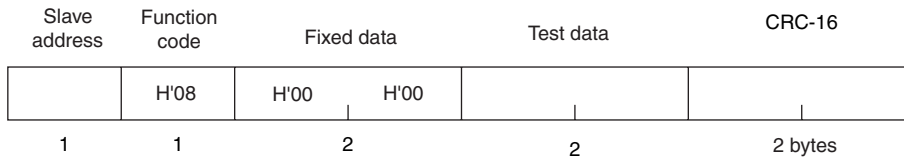

### Response Frame

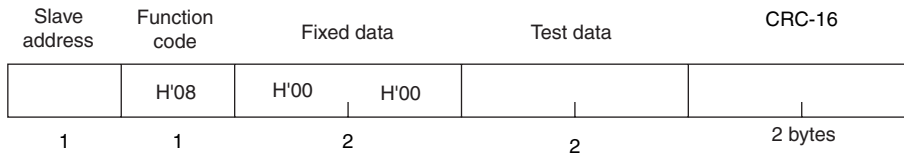

Note: When the command is executed normally, the response returns the same data sent in the command.

#### (1) Test Data

Enter any 2-byte hexadecimal data.

#### (2) Response Code

Function code	Error code	Name	Description
H'88	H'03	Variable data error	A different value (not H'00, H'00) was returned.
H'08	---	Normal completion	No errors were found.

#### (3) Example Command and Response

The following example shows the command/response for an Echoback Test command.

(In this case, the test data is H'1234.)

(In this case, the slave address is H'01.)

Command: 

01	08	00 00	12 34	ED 7C(CRC-16)
----	----	-------	-------	---------------

Response: 

01	08	00 00	12 34	ED 7C(CRC-16)
----	----	-------	-------	---------------



# 5

## Communications Data for Modbus

This section lists the details of the communications data in the Modbus communications protocol.

---

<b>5-1 Variable Area (Setting Range) List .....</b>	<b>5-2</b>
<b>5-2 Status .....</b>	<b>5-17</b>

## 5-1 Variable Area (Setting Range) List

- Four-byte Mode  
One element uses 4 bytes of data (H'00000000 to H'FFFFFFFF), so specify two-element units. Reading and writing in 4-byte units is executed by specifying an even address and specifying the number of elements in multiples of 2.
- Two-byte Mode  
One element uses 2 bytes of data (H'0000 to H'FFFF), so specify one-element units. Reading and writing in 2-byte data units is executed by specifying 1-element units.

The following table lists the variable area. Items expressed in hexadecimal in the "Setting (monitor) value" column are the setting range in the Modbus specifications. Values in parentheses "()" are the actual setting range.

When there is a section reference for a setting item, refer to that reference for details.

Address		Parameter name	Setting (monitor) value	Level
Four-byte mode	Two-byte mode			
0000	2000	PV	Temperature: Use the specified range for each sensor. Analog: Scaling lower limit – 5% FS to Scaling upper limit + 5% FS	Operation
0002	2001	Status <sup>*1*2</sup>	Refer to 5-2 Status for details.	
0004	2002	Internal Set Point <sup>*1</sup>	SP lower limit to SP upper limit	
0006	2003	Heater Current 1 Value Monitor	H'00000000 to H'00000226 (0.0 to 55.0)	
0008	2004	MV Monitor (Heating)	Standard: H'FFFFFFCE to H'0000041A (–5.0 to 105.0) Heating and cooling: H'00000000 to H'0000041A (0.0 to 105.0)	
000A	2005	MV Monitor (Cooling)	H'00000000 to H'0000041A (0.0 to 105.0)	
0106	2103	Set Point	SP lower limit to SP upper limit	
0108	2104	Alarm Value 1	H'FFFFFF831 to H'0000270F (–1999 to 9999)	
010A	2105	Alarm Value Upper Limit 1	H'FFFFFF831 to H'0000270F (–1999 to 9999)	
010C	2106	Alarm Value Lower Limit 1	H'FFFFFF831 to H'0000270F (–1999 to 9999)	
010E	2107	Alarm Value 2	H'FFFFFF831 to H'0000270F (–1999 to 9999)	
0110	2108	Alarm Value Upper Limit 2	H'FFFFFF831 to H'0000270F (–1999 to 9999)	
0112	2109	Alarm Value Lower Limit 2	H'FFFFFF831 to H'0000270F (–1999 to 9999)	
0404	2402	PV	Temperature: Use the specified range for each sensor. Analog: Scaling lower limit – 5% FS to Scaling upper limit + 5% FS	
0406	2403	Internal Set Point <sup>*1</sup>	SP lower limit to SP upper limit	
0408	2404	Multi-SP No. Monitor	H'00000000 to H'00000007 (0 to 7)	
040C	2406	Status <sup>*1*2</sup>	Refer to 5-2 Status for details.	
040E	2407	Status <sup>*3</sup>	Refer to 5-2 Status for details.	
0410	2408	Status 2 <sup>*1*2</sup>	Refer to 5-2 Status for details.	
0412	2409	Status 2 <sup>*1*3</sup>	Refer to 5-2 Status for details.	
0420	2410	Decimal Point Monitor	H'00000000 to H'00000003 (0 to 3)	

\*1 Not displayed on the Controller display.

\*2 In 2-byte mode, the rightmost 16 bits are read.

\*3 In 2-byte mode, the leftmost 16 bits are read.

Address		Parameter name	Setting (monitor) value	Level
Four-byte mode	Two-byte mode			
0500	2500	Operation/Adjustment Protect	H'00000000 (0): No restrictions in operation and adjustment levels H'00000001 (1): Move to adjustment level is prohibited. H'00000002 (2): Display and change of only "PV" and "PV/SP" parameters is allowed. H'00000003 (3): Display of only "PV" and "PV/SP" parameters is allowed.	Protect
0502	2501	Initial Setting/Communications Protect	H'00000000 (0): Move to initial setting/communications setting level is allowed. (Move to advanced function setting level is displayed.) H'00000001 (1): Move to initial setting/communications setting level is allowed. (Move to advanced function setting level is not displayed.) H'00000002 (2): Move to initial setting/communications setting level is prohibited.	
0504	2502	Setting Change Protect	H'00000000 (0): OFF (Changing of setup on controller display is allowed.) H'00000001 (1): ON (Changing of setup on controller display is prohibited.)	
0506	2503	PF Key Protect	H'00000000 (0): OFF H'00000001 (1): ON	
0508	2504	Move to Protect Level	H'FFFFFF831 to H'0000270F (-1999 to 9999)	
050A	2505	Password to Move to Protect Level	H'FFFFFF831 to H'0000270F (-1999 to 9999) (Can only be set. The monitor value is always H'00000000.)	
050C	2506	Parameter Mask Enable	H'00000000 (0): OFF H'00000001 (1): ON	
050E	2507	Changed Parameters Only	H'00000000 (0): OFF H'00000001 (1): ON	
0600	2600	Manual MV	Standard Models Standard control: H'FFFFFFFCE to H'0000041A (-5.0 to 105.0) Heating and cooling control: H'FFFFFFBE6 to H'0000041A (-105.0 to 105.0) Position-proportional Models Close position-proportional control with the Direct Setting of Position Proportional MV parameter set to ON: H'FFFFFFFCE to H'0000041A (-5.0 to 105.0)	Manual control
0602	2601	Set Point	SP lower limit to SP upper limit	Operation
0604	2602	Remote SP Monitor	Remote SP lower limit -10% FS to Remote SP upper limit +10% FS	
0608	2604	Heater Current 1 Value Monitor	H'00000000 to H'00000226 (0.0 to 55.0)	
060A	2605	MV Monitor (Heating)	Standard control: H'FFFFFFFCE to H'0000041A (-5.0 to 105.0) Heating and cooling control: H'00000000 to H'0000041A (0.0 to 105.0)	
060C	2606	MV Monitor (Cooling)	H'00000000 to H'0000041A (0.0 to 105.0)	
060E	2607	Valve Opening Monitor	H'FFFFFFF9C to H'0000044C (-10.0 to 110.0)	

Address		Parameter name	Setting (monitor) value	Level	
Four-byte mode	Two-byte mode				
0702	2701	Proportional Band (Cooling)	H'00000001 to H'0000270F (0.1 to 999.9)	Adjustment	
0704	2702	Integral Time (Cooling)	H'00000000 to H'0000270F (0 to 9999: Integral/derivative time unit is 1 s.) (0.0 to 999.9: Integral/derivative time unit is 0.1 s.)		
0706	2703	Derivative Time (Cooling)	H'00000000 to H'0000270F (0 to 9999: Integral/derivative time unit is 1 s.) (0.0 to 999.9: Integral/derivative time unit is 0.1 s.)		
0708	2704	Dead Band	H'FFFFFF831 to H'0000270F (-199.9 to 999.9 for temperature input) (-19.99 to 99.99 for analog input)		
070A	2705	Manual Reset Value	H'00000000 to H'000003E8 (0.0 to 100.0)		
070C	2706	Hysteresis (Heating)	H'00000001 to H'0000270F (0.1 to 999.9 for temperature input) (0.01 to 99.99 for analog input)		
070E	2707	Hysteresis (Cooling)	H'00000001 to H'0000270F (0.1 to 999.9 for temperature input) (0.01 to 99.99 for analog input)		
0710	2708	Control Period (Heating)	H'FFFFFFFE (-2): 0.1 s H'FFFFFFF (-1): 0.2 s H'00000000 (0): 0.5 s H'00000001 to H'00000063 (1 to 99)		Initial setting
0712	2709	Control Period (Cooling)	H'FFFFFFFE (-2): 0.1 s H'FFFFFFF (-1): 0.2 s H'00000000 (0): 0.5 s H'00000001 to H'00000063 (1 to 99)		
0714	270A	Position Proportional Dead Band	H'00000001 to H'00000064 (0.1 to 10.0)		Adjustment
0716	270B	Open/Close Hysteresis	H'00000001 to H'000000C8 (0.1 to 20.0)		
0718	270C	SP Ramp Time Unit	H'00000000 (0): EU/second H'00000001 (1): EU/minute H'00000002 (2): EU/hour	Advanced function setting	
071A	270D	SP Ramp Set Value	H'00000000 (0): OFF H'00000001 to H'0000270F (1 to 9999)	Adjustment	
071C	270E	SP Ramp Fall Value	H'FFFFFFF (-1): Same (Same as SP Ramp Set Value.) H'00000000 (0): OFF H'00000001 to H'0000270F (1 to 9999)		
071E	270F	MV at Stop	Standard Models		
0722	2711	MV at PV Error	Standard control: H'FFFFFFCE to H'0000041A (-5.0 to 105.0) Heating and cooling control: H'FFFFFFBE6 to H'0000041A (-105.0 to 105.0) Position-proportional Models Close position-proportional control with the Direct Setting of Position Proportional MV parameter set to ON: H'FFFFFFCE to H'0000041A (-5.0 to 105.0) Floating position-proportional control or the Direct Setting of Position Proportional MV parameter set to OFF: H'FFFFFFF to H'00000001 (-1 to 1)		
0726	2713	MV Change Rate Limit	H'00000000 to H'000003E8 (0.0 to 100.0)		
0730	2718	PV Input Slope Coefficient	H'00000001 to H'0000270F (0.001 to 9.999)		
0734	271A	Heater Current 1 Value Monitor	H'00000000 to H'00000226 (0.0 to 55.0)	Operation	
0736	271B	Heater Burnout Detection 1	H'00000000 to H'000001F4 (0.0 to 50.0)	Adjustment	
0738	271C	Leakage Current 1 Monitor	H'00000000 to H'00000226 (0.0 to 55.0)	Operation	
073A	271D	HS Alarm 1	H'00000000 to H'000001F4 (0.0 to 50.0)	Adjustment	
0746	2723	Process Value Input Shift	H'FFFFFF831 to H'0000270F (-1999 to 9999)		
0748	2724	Heater Current 2 Value Monitor	H'00000000 to H'00000226 (0.0 to 55.0)	Operation	

Address		Parameter name	Setting (monitor) value	Level
Four-byte mode	Two-byte mode			
074A	2725	Heater Burnout Detection 2	H'00000000 to H'000001F4 (0.0 to 50.0)	Adjustment
074C	2726	Leakage Current 2 Monitor	H'00000000 to H'00000226 (0.0 to 55.0)	Operation
074E	2727	HS Alarm 2	H'00000000 to H'000001F4 (0.0 to 50.0)	Adjustment
0750	2728	Soak Time Remain	H'00000000 to H'0000270F (0 to 9999)	Operation
0752	2729	Soak Time	H'00000001 to H'0000270F (1 to 9999)	Adjustment
0754	272A	Wait Band	H'00000000 (0): OFF H'00000001 to H'0000270F (0.1 to 999.9 for Temperature input) (0.01 to 99.99 for Analog input)	
0756	272B	Remote SP Input Shift	H'FFFFFF831 to H'0000270F (-1999 to 9999)	
0758	272C	Remote SP input Slope Coefficient	H'00000001 to H'0000270F (0.001 to 9.999)	
0800	2800	Input Digital Filter	H'00000000 to H'0000270F (0.0 to 999.9)	Advanced function setting
0808	2804	Moving Average Count	H'00000000 (0): OFF H'00000001 (1): 2 times H'00000002 (2): 4 times H'00000003 (3): 8 times H'00000004 (4): 16 times H'00000005 (5): 32 times	

Address		Parameter name	Setting (monitor) value	Level
Four-byte mode	Two-byte mode			
0810	2808	Extraction of Square Root Low-cut Point	H'00000000 to H'000003E8 (0.0 to 100.0)	Adjustment
0900	2900	SP 0	SP lower limit to SP upper limit	
0904	2902	Alarm Value 1	H'FFFFFF831 to H'0000270F (-1999 to 9999)	Operation
0906	2903	Alarm Value Upper Limit 1	H'FFFFFF831 to H'0000270F (-1999 to 9999)	
0908	2904	Alarm Value Lower Limit 1	H'FFFFFF831 to H'0000270F (-1999 to 9999)	
090A	2905	Alarm Value 2	H'FFFFFF831 to H'0000270F (-1999 to 9999)	
090C	2906	Alarm Value Upper Limit 2	H'FFFFFF831 to H'0000270F (-1999 to 9999)	
090E	2907	Alarm Value Lower Limit 2	H'FFFFFF831 to H'0000270F (-1999 to 9999)	
0910	2908	Alarm Value 3	H'FFFFFF831 to H'0000270F (-1999 to 9999)	
0912	2909	Alarm Value Upper Limit 3	H'FFFFFF831 to H'0000270F (-1999 to 9999)	
0914	290A	Alarm Value Lower Limit 3	H'FFFFFF831 to H'0000270F (-1999 to 9999)	
0916	290B	Alarm Value 4	H'FFFFFF831 to H'0000270F (-1999 to 9999)	
0918	290C	Alarm Value Upper Limit 4	H'FFFFFF831 to H'0000270F (-1999 to 9999)	
091A	290D	Alarm Value Lower Limit 4	H'FFFFFF831 to H'0000270F (-1999 to 9999)	
091C	290E	SP 1	SP lower limit to SP upper limit	
0938	291C	SP 2	SP lower limit to SP upper limit	
0954	292A	SP 3	SP lower limit to SP upper limit	
0970	2938	SP 4	SP lower limit to SP upper limit	
098C	2946	SP 5	SP lower limit to SP upper limit	
09A8	2954	SP 6	SP lower limit to SP upper limit	
09C4	2962	SP 7	SP lower limit to SP upper limit	
0A00	2A00	Proportional Band	H'00000001 to H'0000270F (0.1 to 999.9)	
0A02	2A01	Integral Time	Standard, heating/cooling, or close position proportional control: H'00000000 to H'0000270F (0 to 9999: Integral/derivative time unit is 1 s.) (0.0 to 999.9: Integral/derivative time unit is 0.1 s.) Floating position-proportional control: H'00000001 to H'0000270F (1 to 9999: Integral/derivative time unit is 1 s.) (0.1 to 999.9: Integral/derivative time unit is 0.1 s.)	
0A04	2A02	Derivative Time	H'00000000 to H'0000270F (0 to 9999: Integral/derivative time unit is 1 s.) (0.0 to 999.9: Integral/derivative time unit is 0.1 s.)	
0A0A	2A05	MV Upper Limit	Standard control or close position-proportional control: MV lower limit + 0.1 to H'0000041A (MV lower limit + 0.1 to 105.0) Heating and cooling control: H'00000000 to H'0000041A (0.0 to 105.0)	
0A0C	2A06	MV Lower Limit	Standard control or close position-proportional control: H'FFFFFFCE to MV upper limit -0.1 (-5.0 to MV upper limit -0.1) Heating and cooling control: H'FFFFFFBE6 to H'00000000 (-105.0 to 0.0)	

Note: The alarm function can also be used in Digital Temperature Controllers that do not have any auxiliary outputs. In this case, confirm alarm occurrences via the status data.



Address		Parameter name	Setting (monitor) value	Level
Four-byte mode	Two-byte mode			
0C00	2C00	Input Type	H'00000000 (0): Pt (-200 to 850°C/-300 to 1500°F) H'00000001 (1): Pt (-199.9 to 500.0°C/-199.9 to 900.0°F) H'00000002 (2): Pt (0.0 to 100.0°C/0.0 to 210.0°F) H'00000003 (3): JPt (-199.9 to 500.0°C/-199.9 to 900.0°F) H'00000004 (4): JPt (0.0 to 100.0°C/0.0 to 210.0°F) H'00000005 (5): K (-200 to 1300°C/-300 to 2300°F) H'00000006 (6): K (-20.0 to 500.0°C/0.0 to 900.0°F) H'00000007 (7): J (-100 to 850°C/-100 to 1500°F) H'00000008 (8): J (-20.0 to 400.0°C/0.0 to 750.0°F) H'00000009 (9): T (-200 to 400°C/-300 to 700°F) H'0000000A (10): T (-199.9 to 400.0°C/-199.9 to 700.0°F) H'0000000B (11): E (-200 to 600°C/-300 to 1100°F) H'0000000C (12): L (-100 to 850°C/-100 to 1500°F) H'0000000D (13): U (-200 to 400°C/-300 to 700°F) H'0000000E (14): U (-199.9 to 400.0°C/-199.9 to 700.0°F) H'0000000F (15): N (-200 to 1300°C/-300 to 2300°F) H'00000010 (16): R (0 to 1700°C/0 to 3000°F) H'00000011 (17): S (0 to 1700°C/0 to 3000°F) H'00000012 (18): B (100 to 1800°C/300 to 3200°F) H'00000013 (19): W (0 to 2,300°C/0 to 3,200°F) H'00000014 (20): PLII (0 to 1,300°C/0 to 2,300°F) H'00000015 (21): Infrared temperature sensor (K 140°F/60°C) H'00000016 (22): Infrared temperature sensor (K 240°F/120°C) H'00000017 (23): Infrared temperature sensor (K 280°F/140°C) H'00000018 (24): Infrared temperature sensor (K 440°F/220°C) H'00000019 (25): 4 to 20 mA H'0000001A (26): 0 to 20 mA H'0000001B (27): 1 to 5 V H'0000001C (28): 0 to 5 V H'0000001D (29): 0 to 10 V H'0000001E (30): 0 to 50 mV* * Selection is possible only for E5CC-U Controllers and only if they are manufactured in May 2014 or later (version 2.2).	Initial setting
0C02	2C01	Temperature Unit	H'00000000 (0): °C H'00000001 (1): °F	
0C12	2C09	Scaling Lower Limit	H'FFFFFF831 to scaling upper limit -1 (-1999 to scaling upper limit -1)	
0C16	2C0B	Scaling Upper Limit	Scaling lower limit + 1 to H'0000270F (Scaling lower limit + 1 to 9999)	
0C18	2C0C	Decimal Point	H'00000000 to 00000003 (0 to 3)	
0C1A	2C0D	Remote SP Upper limit	Input range lower limit to Input range upper limit for temperature input Scaling lower limit to Scaling upper limit for analog input	Advanced function setting
0C1C	2C0E	Remote SP Lower limit	Input range lower limit to Input range upper limit for temperature input Scaling lower limit to Scaling upper limit for analog input	
0C1E	2C0F	PV Decimal Point Display	H'00000000 (0): OFF H'00000001 (1): ON	
0D06	2D03	Control Output 1 Signal	H'00000000 (0): 4 to 20 mA H'00000001 (1): 0 to 20 mA	Initial setting
0D08	2D04	Control Output 2 Signal	H'00000000 (0): 4 to 20 mA H'00000001 (1): 0 to 20 mA	
0D1E	2D0F	SP Upper Limit	The range of values (without decimal point) is as follows: Temperature input: SP lower limit + 1 to Input range upper limit Analog input: SP lower limit + 1 to Scaling upper limit	
0D20	2D10	SP Lower Limit	The range of values (without decimal point) is as follows: Temperature input: Input range lower limit to SP upper limit - 1 Analog input: Scaling lower limit to SP upper limit - 1	
0D22	2D11	Standard or Heating/Cooling	H'00000000 (0): Standard H'00000001 (1): Heating and cooling	

Address		Parameter name	Setting (monitor) value	Level
Four-byte mode	Two-byte mode			
0D24	2D12	Direct/Reverse Operation	H'00000000 (0): Reverse operation H'00000001 (1): Direct operation	Initial setting
0D26	2D13	Close/Floating	H'00000000 (0): Floating H'00000001 (1): Close	
0D28	2D14	PID ON/OFF	H'00000000 (0): ON/OFF H'00000001 (1): 2 PID control	
0D2A	2D15	ST	H'00000000 (0): OFF H'00000001 (1): ON	
0D2C	2D16	Program Pattern	H'00000000 (0): OFF H'00000001 (1): STOP H'00000002 (2): CONT	
0D30	2D18	Remote SP Input	H'00000000 (0): 4 to 20 mA H'00000001 (1): 0 to 20 mA H'00000002 (2): 1 to 5 V H'00000003 (3): 0 to 5 V H'00000004 (4): 0 to 10 V	Advanced function setting
0D32	2D19	Minimum Output ON/OFF Band	H'00000000 to H'00001F4 (0.0 to 50.0)	
0E00	2E00	Transfer Output Type	H'00000000 (0): OFF H'00000001 (1): Set point H'00000002 (2): Set point during SP ramp H'00000003 (3): PV H'00000004 (4): MV (heating) H'00000005 (5): MV (cooling) H'00000006 (6): Valve opening (*Only for Position-proportional Models.)	Initial setting
0E02	2E01	Transfer Output Signal	H'00000000 (0): 4 to 20 mA H'00000001 (1): 1 to 5 V	

Address		Parameter name	Setting (monitor) value	Level
Four-byte mode	Two-byte mode			
0E0C	2E06	Control Output 1 Assignment	Control output 1 is a relay output or voltage output (for driving SSR): H'00000000 (0): Not assigned. H'00000001 (1): Control output (heating) H'00000002 (2): Control output (cooling) H'00000003 (3): Alarm 1 H'00000004 (4): Alarm 2 H'00000005 (5): Alarm 3 H'00000006 (6): Alarm 4 H'00000007 (7): Heater alarm H'00000008 (8): HB alarm H'00000009 (9): HS alarm H'0000000A (10): Input error H'0000000B (11): RSP input error H'0000000C (12): Program end output* <sup>1</sup> H'0000000D (13): RUN output H'0000000E (14): Integrated alarm H'0000000F (15): Work bit 1 H'00000010 (16): Work bit 2 H'00000011 (17): Work bit 3 H'00000012 (18): Work bit 4 H'00000013 (19): Work bit 5 H'00000014 (20): Work bit 6 H'00000015 (21): Work bit 7 H'00000016 (22): Work bit 8 When control output 1 is a linear current output: H'FFFFFFFB (-5): Simple transfer MV (cooling) <sup>*2</sup> H'FFFFFFFC (-4): Simple transfer MV (heating) <sup>*2</sup> H'FFFFFFFD (-3): Simple transfer PV <sup>*2</sup> H'FFFFFFFE (-2): Simple transfer ramp SP <sup>*2</sup> H'FFFFFFF (-1): Simple transfer SP <sup>*2</sup> H'00000000 (0): Not assigned. H'00000001 (1): Control output (heating) H'00000002 (2): Control output (cooling)	Advanced function setting
0E0E	2E07	Control Output 2 Assignment	Control output 2 is a relay output or voltage output (for driving SSR): H'00000000 to H'00000006 (0 to 2) Note: Same as for the Control Output 1 Assignment parameter. When control output 2 is a linear current output: H'00000000 to H'00000002 (0 to 2) Note: Same as for the Control Output 1 Assignment parameter, except for items marked with “*2.”	

- \*1 P.END (program end output) can be set even when the program pattern is set to OFF, but the function will be disabled.
- \*2 Selection is possible only with the E5CC-U and E5GC and only when there is a control output that is a linear current output. (For the E5CC-U, the Controller must have been manufactured in May 2014 or later (version 2.2).)

Address		Parameter name	Setting (monitor) value	Level
Four-byte mode	Two-byte mode			
0E14	2E0A	Event Input Assignment 1	H'00000000 (0): None H'00000001 (1): RUN/STOP H'00000002 (2): Auto/Manual Switch H'00000003 (3): Program Start* <sup>1</sup> H'00000004 (4): Direct/Reverse Operation H'00000005 (5): SP Mode Switch* <sup>2</sup> H'00000006 (6): 100% AT Execute/Cancel H'00000007 (7): 40% AT Execute/Cancel H'00000008 (8): Setting Change Enable/Disable H'00000009 (9): Communications Writing Enable/Disable* <sup>3</sup> H'0000000A (10): Alarm Latch Cancel H'0000000B (11): Multi-SP No. Switch, Bit 0 H'0000000C (12): Multi-SP No. Switch, Bit 1 H'0000000D (13): Multi-SP No. Switch, Bit 2	Initial setting
0E16	2E0B	Event Input Assignment 2	H'00000000 to H'0000000D (0 to 13) Note: Same as for Event Input Assignment 1.	
0E18	2E0C	Event Input Assignment 3	H'00000000 to H'0000000D (0 to 13) Note: Same as for Event Input Assignment 1.	
0E1A	2E0D	Event Input Assignment 4	H'00000000 to H'0000000D (0 to 13) Note: Same as for Event Input Assignment 1.	
0E1C	2E0E	Event Input Assignment 5	H'00000000 to H'0000000D (0 to 13) Note: Same as for Event Input Assignment 1.	
0E1E	2E0F	Event Input Assignment 6	H'00000000 to H'0000000D (0 to 13) Note: Same as for Event Input Assignment 1.	
0E20	2E10	Auxiliary Output 1 Assignment	H'00000000 (0): Not assigned. H'00000001 (1): Control output (heating) H'00000002 (2): Control output (cooling) H'00000003 (3): Alarm 1 H'00000004 (4): Alarm 2 H'00000005 (5): Alarm 3 H'00000006 (6): Alarm 4 H'00000007 (7): Heater alarm H'00000008 (8): HB alarm H'00000009 (9): HS alarm H'0000000A (10): Input error H'0000000B (11): RSP input error H'0000000C (12): Program end output* <sup>4</sup> H'0000000D (13): RUN output H'0000000E (14): Integrated alarm H'0000000F (15): Work bit 1 H'00000010 (16): Work bit 2 H'00000011 (17): Work bit 3 H'00000012 (18): Work bit 4 H'00000013 (19): Work bit 5 H'00000014 (20): Work bit 6 H'00000015 (21): Work bit 7 H'00000016 (22): Work bit 8	Advanced function setting
0E22	2E11	Auxiliary Output 2 Assignment	H'00000000 to H'00000016 (0 to 22) Note: Same as for the Auxiliary Output 1 Assignment parameter.	
0E24	2E12	Auxiliary Output 3 Assignment	H'00000000 to H'00000016 (0 to 22) Note: Same as for the Auxiliary Output 1 Assignment parameter.	
0E26	2E13	Auxiliary Output 4 Assignment	H'00000000 to H'00000016 (0 to 22) Note: Same as for the Auxiliary Output 1 Assignment parameter.	
0E28	2E14	Transfer Output Upper Limit	H'FFFFFF831 to H'0000270F (–1999 to 9999) * <sup>2</sup>	
0E2A	2E15	Transfer Output Lower Limit	H'FFFFFF831 to H'0000270F (–1999 to 9999) * <sup>2</sup>	Initial setting

\*1 PRST (program start) can be set even when the program pattern is set to OFF, but the function will be disabled.

\*2 Selection is possible only if there is a remote SP input.

\*3 Selection is possible only if external communications is supported.

\*4 The setting (monitor) range depends on the transfer output type setting. Refer to *Section 6 Parameters* in the *E5□C Digital Temperature Controller User's Manual* (Cat. No. H174).

\*5 P.END (program end output) can be set even when the program pattern is set to OFF, but the function will be disabled.

Address		Parameter name	Setting (monitor) value	Level
Four-byte mode	Two-byte mode			
0E2C	2E16	Simple Transfer Output 1 Upper Limit	H'FFFFFF831 to H'0000270F (-1999 to 9999)* <sup>1</sup>	Initial setting
0E2E	2E17	Simple Transfer Output 1 Lower Limit	H'FFFFFF831 to H'0000270F (-1999 to 9999)* <sup>1</sup>	

\*1 Selection is possible only with the E5CC-U and E5GC and only when there is a control output that is a linear current output. (For the E5CC-U, the Controller must have been manufactured in May 2014 or later (version 2.2).)

Address		Parameter name	Setting (monitor) value	Level
Four-byte mode	Two-byte mode			
0E48	2E24	Extraction of Square Root Enable	H'00000000 (0): OFF H'00000001 (1): ON	Initial setting
0E60	2E30	Travel Time	H'00000001 to H'000003E7 (1 to 999)	
0F00	2F00	Alarm 1 Type	H'00000000 (0): Alarm function OFF H'00000001 (1): Upper and lower-limit alarm H'00000002 (2): Upper-limit alarm H'00000003 (3): Lower-limit alarm H'00000004 (4): Upper and lower-limit range alarm H'00000005 (5): Upper and lower-limit alarm with standby sequence H'00000006 (6): Upper-limit alarm with standby sequence H'00000007 (7): Lower-limit alarm with standby sequence H'00000008 (8): Absolute-value upper-limit alarm H'00000009 (9): Absolute-value lower-limit alarm H'0000000A (10): Absolute-value upper-limit alarm with standby sequence H'0000000B (11): Absolute-value lower-limit alarm with standby sequence H'0000000C (12): LBA (Loop Burnout Alarm) H'0000000D (13): PV change rate alarm H'0000000E (14): SP absolute-value upper-limit alarm H'0000000F (15): SP absolute-value lower-limit alarm H'00000010 (16): MV absolute-value upper-limit alarm H'00000011 (17): MV absolute-value lower-limit alarm H'00000012 (18): RSP absolute-value upper-limit alarm * H'00000013 (19): RSP absolute-value lower-limit alarm * * Valid only with a remote SP input.	Advanced function setting
0F02	2F01	Alarm 1 Latch	H'00000000 (0): OFF H'00000001 (1): ON	
0F04	2F02	Alarm 1 Hysteresis	H'00000001 to H'0000270F (0.1 to 999.9 for temperature input) (0.01 to 99.99 for analog input)	Initial setting
0F06	2F03	Alarm 2 Type	H'00000000 to H'00000013 (0 to 19) Note: Same settings as the Alarm 1 Type. However, the LBA (loop burnout alarm) cannot be set.	
0F08	2F04	Alarm 2 Latch	H'00000000 (0): OFF H'00000001 (1): ON	Advanced function setting
0F0A	2F05	Alarm 2 Hysteresis	H'00000001 to H'0000270F (0.1 to 999.9 for temperature input) (0.01 to 99.99 for analog input)	Initial setting
0F0C	2F06	Alarm 3 Type	H'00000000 to H'00000013 (0 to 19) Note: Same settings as the Alarm 1 Type. However, the LBA (loop burnout alarm) cannot be set.	
0F0E	2F07	Alarm 3 Latch	H'00000000 (0): OFF H'00000001 (1): ON	Advanced function setting
0F10	2F08	Alarm 3 Hysteresis	H'00000001 to H'0000270F (0.1 to 999.9 for temperature input) (0.01 to 99.99 for analog input)	Initial setting
0F12	2F09	Alarm 4 Type	H'00000000 to H'00000013 (0 to 19) Note: Same settings as the Alarm 1 Type. However, the LBA (loop burnout alarm) cannot be set.	
0F14	2F0A	Alarm 4 Latch	H'00000000 (0): OFF H'00000001 (1): ON	Advanced function setting
0F16	2F0B	Alarm 4 Hysteresis	H'00000001 to H'0000270F (0.1 to 999.9 for temperature input) (0.01 to 99.99 for analog input)	Initial setting
0F18	2F0C	Standby Sequence Reset	H'00000000 (0): Condition A H'00000001 (1): Condition B	
0F1A	2F0D	Auxiliary Output 1 Open in Alarm	H'00000000 (0): Close in alarm H'00000001 (1): Open in alarm	Advanced function setting

Address		Parameter name	Setting (monitor) value	Level
Four-byte mode	Two-byte mode			
0F1C	2F0E	Auxiliary Output 2 Open in Alarm	H'00000000 (0): Close in alarm H'00000001 (1): Open in alarm	Advanced function setting
0F1E	2F0F	Auxiliary Output 3 Open in Alarm	H'00000000 (0): Close in alarm H'00000001 (1): Open in alarm	
0F20	2F10	Auxiliary Output 4 Open in Alarm	H'00000000 (0): Close in alarm H'00000001 (1): Open in alarm	
0F22	2F11	Alarm 1 ON delay	H'00000000 to H'000003E7 (0 to 999)	
0F24	2F12	Alarm 2 ON delay	H'00000000 to H'000003E7 (0 to 999)	
0F26	2F13	Alarm 3 ON delay	H'00000000 to H'000003E7 (0 to 999)	
0F28	2F14	Alarm 4 ON delay	H'00000000 to H'000003E7 (0 to 999)	
0F2A	2F15	Alarm 1 OFF delay	H'00000000 to H'000003E7 (0 to 999)	
0F2C	2F16	Alarm 2 OFF delay	H'00000000 to H'000003E7 (0 to 999)	
0F2E	2F17	Alarm 3 OFF delay	H'00000000 to H'000003E7 (0 to 999)	
0F30	2F18	Alarm 4 OFF delay	H'00000000 to H'000003E7 (0 to 999)	
1000	3000	PV/SP No. 1 Display Selection	H'00000000 (0):Nothing displayed. H'00000001 (1):PV/SP H'00000002 (2):PV H'00000003 (3):PV/SP (character display) H'00000004 (4):PV/SP/MV H'00000005 (5):PV/SP/Multi-SP No. H'00000006 (6):PV/SP/Soak time remain H'00000007 (7):PV/SP/Ramp SP H'00000008 (8):PV/SP/Alarm value 1	
1002	3001	MV Display Selection	H'00000000 (0): MV (heating) H'00000001 (1): MV (cooling)	
1006	3003	Automatic Display Return Time	H'00000000 (0): OFF H'00000001 to H'00000063 (1 to 99)	
1008	3004	Display Refresh Period	H'00000000 (0):OFF H'00000001 (1): 0.25 H'00000002 (2): 0.5 H'00000003 (3): 1.0	
1010	3008	PV/SP No. 2 Display Selection	H'00000000 to H'00000008 (0 to 8) Note: Same as PV/SP No. 1 Display Selection.	
1014	300A	Display Brightness	H'00000001 to H'00000003 (1 to 3)	
1016	300B	MV Display	H'00000000 (0): OFF H'00000001 (1): ON	
1018	300C	Move to Protect Level Time	H'00000001 to H'0000001E (1 to 30)	
101E	300F	Auto/Manual Select Addition	H'00000000 (0): OFF H'00000001 (1): ON	
1022	3011	PV Status Display Function	H'00000000 (0): OFF H'00000001 (1): Manual H'00000002 (2): Stop H'00000003 (3): Alarm 1 H'00000004 (4): Alarm 2 H'00000005 (5): Alarm 3 H'00000006 (6): Alarm 4 H'00000007 (7): Alarm 1 to 4 OR status H'00000008 (8): Heater alarm H'00000009 (9): Status display message*1	
1024	3012	SV Status Display Function	H'00000000 to H'00000009 (0 to 9) Note: Same as for PV Status Display Function.	

\*1 Selection is possible only with the E5GC.

Address		Parameter name	Setting (monitor) value	Level
Four-byte mode	Two-byte mode			
1100	3100	Protocol Setting (See note.)	H'00000000 (0): CompoWay/F H'00000001 (1): Modbus	Communications setting
1102	3101	Communications Unit No. *	H'00000000 to H'00000063 (0 to 99)	
1104	3102	Communications Baud Rate *	H'00000003 (3): 9.6 H'00000004 (4): 19.2 H'00000005 (5): 38.4 H'00000006 (6): 57.6	
1106	3103	Communications Data Length *	H'00000007 (7): 7 H'00000008 (8): 8	
1108	3104	Communications Stop Bits *	H'00000001 (1): 1 H'00000002 (2): 2	
110A	3105	Communications Parity *	H'00000000 (0): None H'00000001 (1): Even H'00000002 (2): Odd	
110C	3106	Send Data Wait Time *	H'00000000 to H'00000063 (0 to 99)	
1200	3200	PF Setting	H'00000000 (0): Disabled H'00000001 (1): Run H'00000002 (2): Stop H'00000003 (3): RUN/STOP H'00000004 (4): 100% AT execute/cancel H'00000005 (5): 40% AT execute/cancel H'00000006 (6): Alarm latch cancel H'00000007 (7): Auto/manual switch H'00000008 (8): Monitor/setting item H'00000009 (9): Digit shift key	
1204	3202	Monitor/Setting Item 1	H'00000000 (0): Disabled H'00000001 (1): PV/SP/multi-SP H'00000002 (2): PV/SP/MV H'00000003 (3): PV/SP/soak time remain H'00000004 (4): Proportional band H'00000005 (5): Integral time H'00000006 (6): Derivative time H'00000007 (7): Alarm value 1 H'00000008 (8): Alarm value upper limit 1 H'00000009 (9): Alarm value lower limit 1 H'0000000A (10): Alarm value 2 H'0000000B (11): Alarm value upper limit 2 H'0000000C (12): Alarm value lower limit 2 H'0000000D (13): Alarm value 3 H'0000000E (14): Alarm value upper limit 3 H'0000000F (15): Alarm value lower limit 3 H'00000010 (16): Alarm value 4 H'00000011 (17): Alarm value upper limit 4 H'00000012 (18): Alarm value lower limit 4 H'00000013 (19): PV/SP/Internal set point H'00000014 (20): PV/SP/Alarm value 1 H'00000015 (21): Proportional Band (Cooling) H'00000016 (22): Integral Time (Cooling) H'00000017 (23): Derivative Time (Cooling)	
1206	3203	Monitor/Setting Item 2	H'00000000 to H'00000017 (0 to 23) Note: Same as for Monitor/Setting Item 1.	
1208	3204	Monitor/Setting Item 3	H'00000000 to H'00000017 (0 to 23) Note: Same as for Monitor/Setting Item 1.	
120A	3205	Monitor/Setting Item 4	H'00000000 to H'00000017 (0 to 23) Note: Same as for Monitor/Setting Item 1.	
120C	3206	Monitor/Setting Item 5	H'00000000 to H'00000017 (0 to 23) Note: Same as for Monitor/Setting Item 1.	

\* After communications parameters have been changed, reset the Digital Controller to enable them.



Address		Parameter name	Setting (monitor) value	Level
Four-byte mode	Two-byte mode			
1302	3301	SP Tracking	H'00000000 (0): OFF H'00000001 (1): ON	Advanced function setting
1308	3304	PV Dead Band	H'00000000 to H'0000270F (0 to 9999)	
130A	3305	Cold Junction Compensation Method	H'00000000 (0): OFF H'00000001 (1): ON	
1312	3309	Integral/Derivative Time Unit	H'00000000 (0): 1 s H'00000001 (1): 0.1 s	
1314	330A	$\alpha$	H'00000000 to H'00000064 (0.00 to 1.00)	
1318	330C	Manual Output Method	H'00000000 (0): HOLD H'00000001 (1): INIT	
131A	330D	Manual MV Initial Value	Standard control or close position-proportional control: H'FFFFFFCE to H'0000041A (-5.0 to 105.0) Heating and cooling control: H'FFFFFFBE6 to H'0000041A (-105.0 to 105.0)	
131E	330F	AT Calculated Gain	H'00000001 to H'00000064 (0.1 to 10.0)	
1320	3310	AT Hysteresis	H'00000001 to H'0000270F (0.1 to 999.9 for temperature input) H'00000001 to H'000003E7 (0.01 to 9.99 for analog input)	
1322	3311	Limit Cycle MV Amplitude	H'00000032 to H'000001F4 (5.0 to 50.0)	
1328	3314	Heater Burnout Latch	H'00000000 (0): OFF H'00000001 (1): ON	
132A	3315	Heater Burnout Hysteresis	H'00000001 to H'000001F4 (0.1 to 50.0)	
132C	3316	HS Alarm Latch	H'00000000 (0): OFF H'00000001 (1): ON	
132E	3317	HS Alarm Hysteresis	H'00000001 to H'000001F4 (0.1 to 50.0)	
1336	331B	Number of Multi-SP Points	H'00000001 (1): OFF H'00000002 to H'00000008 (2 to 8)	
1338	331C	HB ON/OFF	H'00000000 (0): OFF H'00000001 (1): ON	
133C	331E	Integrated Alarm Assignment	H'00000000 to H'000000FF (0 to 255)	
1340	3320	MV at Stop and Error Addition	H'00000000 (0): OFF H'00000001 (1): ON	
1342	3321	ST Stable Range	H'00000001 to H'0000270F (0.1 to 999.9)	
1344	3322	RT	H'00000000 (0): OFF H'00000001 (1): ON Note: Valid only with temperature input.	
1346	3323	HS Alarm Use	H'00000000 (0): OFF H'00000001 (1): ON	
1348	3324	LBA Detection Time	H'00000000 to H'0000270F (0 to 9999)	
134A	3325	LBA Level	H'00000001 to H'0000270F (0.1 to 999.9 for temperature input) (0.01 to 99.99 for analog input)	
134C	3326	LBA Band	H'00000000 to H'0000270F (0.0 to 999.9 for temperature input) (0.00 to 99.99 for analog input)	
134E	3327	Soak Time Unit	H'00000000 (0): Minutes H'00000001 (1): Hours H'00000002 (2): Seconds <sup>*1</sup>	
1350	3328	Alarm SP Selection	H'00000000 (0): Set point during SP ramp H'00000001 (1): Set point	
1352	3329	Remote SP Enable	H'00000000 (0): OFF H'00000001 (1): ON	
1356	332B	Manual MV Limit Enable	H'00000000 (0): OFF H'00000001 (1): ON	
1358	332C	Direct Setting of Position Proportional MV	H'00000000 (0): OFF H'00000001 (1): ON	
135A	332D	PV Rate of Change Calculation Period	H'00000001 to H'000003E7 (1 to 999)	

\*1 Selection is possible only with the E5GC.

Address		Parameter name	Setting (monitor) value	Level
Four-byte mode	Two-byte mode			
135C	332E	Heating/Cooling Tuning Method	H'00000000 (0): Same as heating control. H'00000001 (1): Linear H'00000002 (2): Air cooling H'00000003 (3): Water cooling	Advanced function setting
136A	3335	LCT Cooling Output Minimum ON Time (Not supported on version 2.0 or earlier of the E5CC, E5EC, or E5AC.)	H'00000001 to H'0000000A (0.1 to 1.0)	

## 5-2 Status

---

The status data for Modbus is the same as that for CompoWay/F. Refer to page 3-22.



# 6

## Programless Communications

This section describes programless communications for the E5□C.  
Programless communications are not supported by version 1.0 of the E5CC/EC.

<b>6-1</b>	<b>Programless Communications</b>	<b>6-3</b>
6-1-1	Introduction	6-3
6-1-2	Features	6-3
6-1-3	Operation for Programless Communications	6-4
6-1-4	Timing of Turning Power ON and OFF	6-4
6-1-5	Connectable PLCs	6-5
<b>6-2</b>	<b>E5@C Setup</b>	<b>6-6</b>
6-2-1	Protocol Setting	6-6
6-2-2	Communications Unit No. and Communications Baud Rate	6-7
6-2-3	Send Data Wait Time	6-7
6-2-4	Highest Communications Unit No.	6-7
6-2-5	Areas and First Address of Linked Data	6-8
6-2-6	Receive Data Wait Time	6-10
6-2-7	Communications Node Number	6-10
6-2-8	Upload Settings and Download Settings	6-11
6-2-9	Copying Parameter Settings	6-13
6-2-10	Communications Writing	6-15
6-2-11	Communications Monitor Parameter	6-16
<b>6-3</b>	<b>Controlling Programless Communications</b>	<b>6-17</b>
6-3-1	Controlling Programless Communications with the Request Flag	6-17
6-3-2	Response Flag	6-18
6-3-3	Range of Operation for Programless Communications	6-19
6-3-4	Operation Command Codes	6-19
6-3-5	Confirming Operation of Programless Communications	6-19
6-3-6	Write Mode	6-20
6-3-7	Troubleshooting	6-20
<b>6-4</b>	<b>Connecting to CP-series PLCs</b>	<b>6-21</b>
6-4-1	Configuration and Procedure	6-21
6-4-2	Switch Settings and Wiring	6-22
6-4-3	PLC Setup	6-22
6-4-4	E5@C Controller Setup	6-25
6-4-5	Checking Operation	6-27

<b>6-5</b>	<b>Connecting to CJ-series PLCs</b>	<b>6-32</b>
6-5-1	Configuration and Procedure	6-32
6-5-2	Switch Settings and Wiring	6-33
6-5-3	PLC Setup	6-33
6-5-4	E5@C Controller Setup	6-36
6-5-5	Checking Operation	6-36
<b>6-6</b>	<b>Connecting to MELSEC Q-series PLCs</b>	<b>6-37</b>
6-6-1	Configuration and Procedure	6-37
6-6-2	Wiring	6-38
6-6-3	PLC Setup	6-38
6-6-4	E5@C Controller Setup	6-43
6-6-5	Checking Operation	6-44
<b>6-7</b>	<b>Connecting to MELSEC-FX-series PLCs</b>	<b>6-49</b>
6-7-1	Configuration and Procedure	6-49
6-7-2	Wiring	6-50
6-7-3	PLC Setup	6-50
6-7-4	E5@C Controller Setup	6-55
6-7-5	Checking Operation	6-55
<b>6-8</b>	<b>Connecting to Keyence KV-series PLCs</b>	<b>6-56</b>
6-8-1	Configuration and Procedure	6-56
6-8-2	Wiring	6-57
6-8-3	PLC Setup	6-57
6-8-4	E5@C Controller Setup	6-58
6-8-5	Checking Operation	6-58

# 6-1 Programless Communications

## 6-1-1 Introduction

With programless communications you can read and write E5□C parameters or start and stop the E5□C from a Programmable Controller (PLC). Communications with the PLC are performed automatically by the E5□C, so there is no need to program communications.

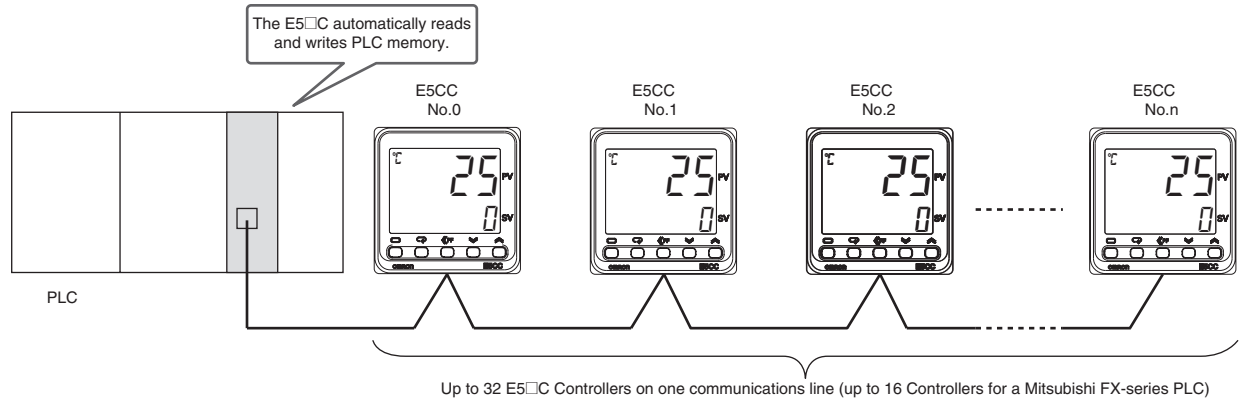

## 6-1-2 Features

- You can connect to an OMRON CS/CJ-series or CP-series PLC, to a Mitsubishi Q-series, L-series, or FX-series PLC, or to a Keyence KV-series PLC.
- Up to 13 E5□C parameters can be assigned for reading and up to 13 E5□C parameters can be assigned for writing in PLC memory. Each E5□C Controller is allocated 30 words of PLC memory. (Only 12 parameters can be read for Mitsubishi FX-series or Keyence KV-series PLCs.)
- You can set the PLC memory area and addresses to use for programless communications.
- You can copy settings between E5□C Controllers to greatly reduce setup work and setting mistakes.

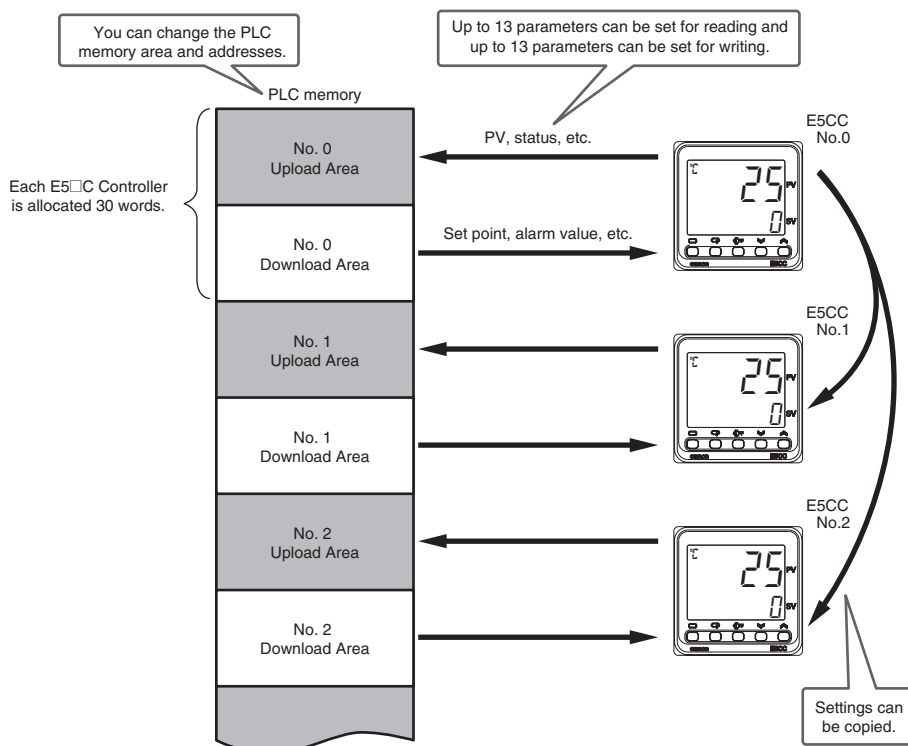

### 6-1-3 Operation for Programless Communications

Programless communications are performed in the following order of communications unit numbers.

0 (master) → 1 → 2 → ... → Highest communications unit number → 0 → 1...

The master (the Controller with communications unit number 0) starts programless communications approximately five seconds after the power supply to it is turned ON. (Communications are not performed until the power supply to the master is turned ON.) When the master starts communications, the slaves (the Controllers with a communications unit number other than 0) also start communications. After communications have started, they will continue for the remaining E5□C Controllers even if one or more of them (including the master) stop. However, the communications cycle will increase while waiting for communications from the stopped E5□C Controllers.

### 6-1-4 Timing of Turning Power ON and OFF

#### ● Turning ON Power

Turn ON the power supply to the E5□C Controllers either after the PLC or at the same time as the PLC. The following may occur if the power supply is turned ON to the PLC after programless communications have started.

- The PLC may detect a communications error.
- The Response Flag may change to  $\overline{EEEE}$  once at startup.

#### ● Turning OFF Power to Mitsubishi PLCs

To turn OFF the power supply while communications with the PLC are active, change the E5□C Controller to the initial setting level first, and then turn OFF the power supply. If you turn OFF the power supply to an E5□C Controller during programless communications, the PLC may detect a communications error.

#### ● Restarting only the E5□C Controllers

Use the following procedure to restart the E5□C Controllers.

- 1** Move all of the E5□C Controllers to the initial setting level.
- 2** Cycle the power supply in order to the slaves (the Controllers with a communications unit number other than 0) and then to the master (the Controller with a communications unit number of 0), or change the slaves and then the master back to the operation level.

Note: If the above procedure is not followed and the PLC detects an error, clear the error from the program in the PLC.



## 6-1-5 Connectable PLCs

The PLCs that can be connected are given below.

### SYSMAC CS/CJ-series and CP-series PLCs

Name	Model number	Communications ports	
		Port 1	Port 2
Serial Communications Units	CJ1W-SCU21-V1 CJ1W-SCU22	RS-232C	RS-232C
	CJ1W-SCU41-V1 CJ1W-SCU42	RS-422A/485 (Cannot be used.)	RS-232C
	CS1W-SCU21-V1	RS-232C	RS-232C
Serial Communications Board	CS1W-SCB21-V1	RS-232C	RS-232C
	CS1W-SCB41-V1		RS-422A/485 (Cannot be used.)
CPU Units	CS1/CJ1M CPU Units	RS-232C	
	CJ2 CPU Units	RS-232C or option board slot	
	CP-series CPU Units	RS-232C	Option board slot
Serial Communications Option Boards *	CP1W-CIF11 CP1W-CIF12	RS-422A/485	

Note: The CJ1W-CIF11 RS-422A Converter is required to use an RS-232C port.

\* The Option Board is mounted in the option board slot that is given above.

### MELSEC Q-series, L-series, and FX-series PLCs

Name	Model number	Communications ports	
		Port 1	Port 2
Q Corresponding Serial Communication Module	QJ71C24N	RS-232C (Cannot be used.)	RS-422/485
	QJ71C24N-R4	RS-422/485	RS-422/485
L Corresponding Serial Communication Module	LJ71C24	RS-232C (Cannot be used.)	RS-422/485
FX1N/1NC* Corresponding Function Expansion Board or Special Adapter	FX2NC-485ADP FX1N-485-BD	RS-485	
FX2N/2NC* Corresponding Function Expansion Board or Special Adapter	FX2NC-485ADP FX2N-485-BD		
Function Expansion Board or Special Adapter for FX3S/3G/3GC*	FX3U-485ADP-MB FX3G-485-BD		
Function Expansion Board or Special Adapter for FX3U/3UC*	FX3U-485ADP-MB FX3U-485-BD		

\* Up to 16 E5□C Controllers can be connected to an FX-series PLC.

### Keyence KV-series PLCs

Name	Model number	Communications ports	
		Port 1	Port 2
Serial Communication Unit	KV-L21V	RS-232C (Cannot be used.)	RS-232C/422A/485

## 6-2 E5□C Setup

The parameters that are used for programless communications are shown with a gray background in the following diagram. These parameters will be displayed if you set the Protocol Setting parameter to *FINS*, *MCP4*, or *FxP4*. (Some of the parameters are always displayed.) The parameters in the communications setting level are described first, followed by those in the adjustment level.

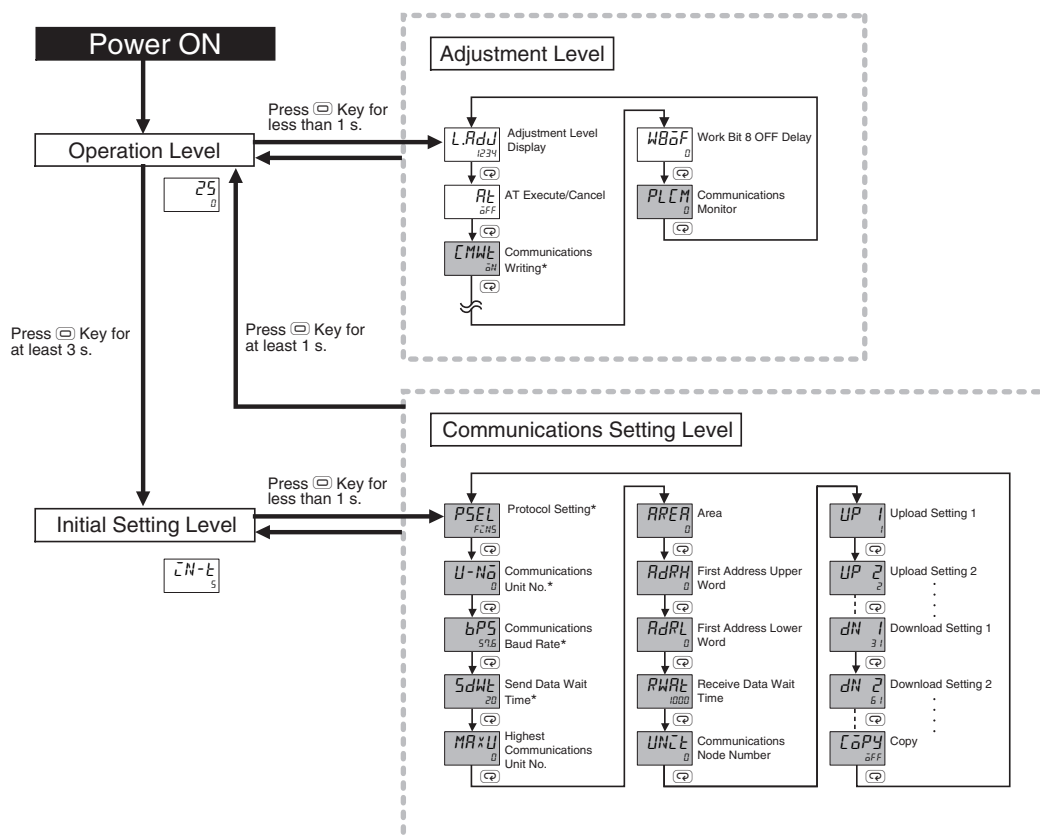

\* These parameters are displayed regardless of the setting of the Protocol Setting parameter.  
 Note: The Communications Data Length, Communications Stop Bits, and Communications Parity parameters in the communications setting level are not displayed.

### 6-2-1 Protocol Setting

Set the Protocol Setting parameter to *FINS* to connect to an OMRON PLC, *MCP4* to connect to a Mitsubishi Q-series or L-series PLC, *FxP4* to connect to a Mitsubishi FX-series or Keyence KV-series PLC, and *CMC* to use component communications. Refer to 6-1-5 *Connectable PLCs* for lists of the PLCs that can be connected.

Refer to 7-1 *Component Communications* for information on component communications.

#### Communications Setting Level

Display condition: None

Parameter name	Displayed characters	Setting range	Default
Protocol Setting	<i>PSEL</i>	<i>CMC</i> : CompoWay/F <i>Mod</i> : ModbusRTU <i>CMC</i> : Component communications <i>FINS</i> : Host Link (FINS) <i>MCP4</i> : MC protocol (format 4) <i>FxP4</i> : Dedicated protocol (format 4)*	<i>CMC</i>

\* Selection is possible only for E5□C version 2.1 or later.

## 6-2-2 Communications Unit No. and Communications Baud Rate

Always assign communications unit numbers in order starting from 0. Do not skip any numbers. Communications unit number 0 is for the master. The recommended communications baud rate is 19.2 for a Mitsubishi FX1 or FX2 PLC, 38.4 for a Mitsubishi FX3 PLC, and 57.6 for any other PLC. Set the same communications baud rate for all of the E5□C Controllers and the PLC. (Setting the PLC is required only for programless communications.)

Communications Setting Level

Display condition: None

Parameter name	Displayed characters	Setting range	Default
Communications Unit No.	<i>U-No</i>	0: Master 1 to 31: Slaves	1
Communications Baud Rate	<i>bPS</i>	9.6: 9600bps 19.2: 19200bps 38.4: 38400bps 57.6: 57600bps	9.6

## 6-2-3 Send Data Wait Time

This is the time that the E5□C will wait from the time that it receives a response from the PLC (or, for component communications, from an E5□C slave) until it sends the next command. We recommend a send data wait time setting of 1. Increase the set value of this parameter if the command is sent too soon to allow the PLC (or, for component communications, the E5□C slave) to receive it.

Communications Setting Level

Display condition: None

Parameter name	Displayed characters	Setting range	Default
Send Data Wait Time	<i>SDWT</i>	0 to 99 ms	20 ms

## 6-2-4 Highest Communications Unit No.

Set the Highest Communications Unit No. parameter to the highest communications unit number that is actually set on the connected E5□C Controllers.

Make sure that setting of the Highest Communications Unit No. parameter agrees with the unit numbers of the E5□C Controllers that are actually connected.

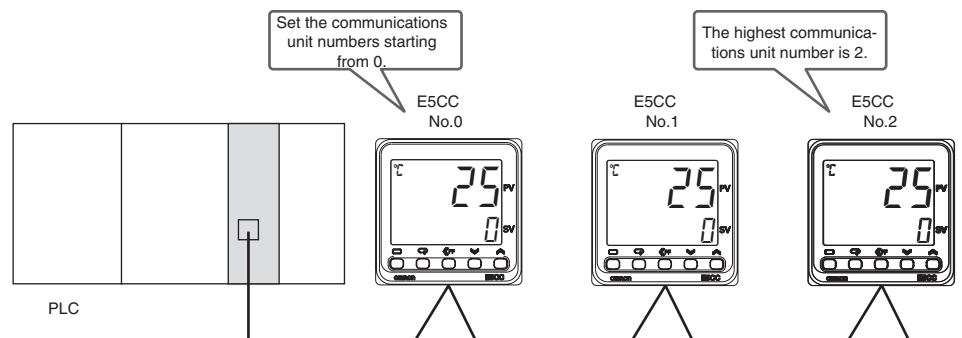

Communications Setting Level

Display condition: The Protocol Setting parameter must be set to *F<sub>LN</sub>S*, *M<sub>CP</sub>4*, or *F<sub>X</sub>P4*, or the Protocol Setting parameter must be set to *C<sub>MP</sub>* and the Communications Unit No. parameter must be set to 0 (master).

Parameter name	Displayed characters	Setting range	Default
Highest Communications Unit No.	<i>MRxU</i>	0 to 99	0

**6-2-5 Areas and First Address of Linked Data**

Two areas are used in PLC memory by the E5□C, an upload area and a download area. The upload area is used to monitor the process value, status, and other information from the E5□C. The download area is used to write the set point, alarm values, and other values to the E5□C.

	Address	Data in PLC memory	
Upload Area	XXXX	Response Flag	This flag indicates the completion of processing for the Request Flag.
	+1	Communications Status	The status that is given at this address is used in the PLC to check the operation of programless communications.
	+2	Monitor Value 1	Information from the E5□C, such as the PV or status, is set at these addresses. The parameters that are actually used are set in the upload settings.
	+3	Monitor Value 2	
		...	
+14	Monitor Value 13		
Download Area	+15	Request Flag	This flag is used to control programless communications.
	+16	Operation Command Code	The operation command that corresponds to the code is sent.
	+17	Set Value 1	The set values at these addresses are written to the E5□C, such as to the set point or alarm values. The parameters that are actually used are set in the download settings.
	+18	Set Value 2	
		...	
	+29	Set Value 13	

The Response Flag, Communications Status, Request Flag, and Operation Command Code all have special functions that cannot be changed. Refer to the following sections for application methods.

Request Flag: *6-3-1 Controlling Programless Communications with the Request Flag*

Response Flag: *6-3-2 Response Flag*

Operation Command Code: *6-3-4 Operation Command Codes*

Communications Status: *6-3-5 Confirming Operation of Programless Communications*

The portion of PLC memory to use is set with the Area, First Address Upper Word, and First Address Lower Word parameters.

Note: If more than one E5□C Controller is connected to the same communications line, set the starting address to the same value for all of them. The E5□C Controller with communications unit number 0 will use the words that start from the specified starting address, the E5□C Controller with unit number 1 will use the words that start from the specified starting address plus 30 words, and the E5□C Controller with unit number 2 will use the words that start from the specified starting address plus 60 words

	Address	Data in PLC memory		E5□C
Each E5□C Controller is allocated 30 words.	XXXX	Response Flag	←	Communications Unit Number 0
	+1	Communications Status		
	+2	Monitor Value 1		
		...		
	+15	Request Flag		
	+16	Operation Command Code	→	
	+17	Set Value 1		
		...		
	+30	Response Flag		
	+31	Communications Status		←
...	...			

## Communications Setting Level

Display condition: The Protocol Setting parameter must be set to *FINS*, *MCP4*, or *FXP4*.

Parameter name	Displayed characters	Setting range	Default																																				
Area	<i>AREA</i>	<ul style="list-style-type: none"> <li>When Protocol Setting Parameter Is Set to FINS               <table border="0"> <tr><td>0: DM</td><td>13: EMC</td></tr> <tr><td>1: EM0</td><td>14: EMD</td></tr> <tr><td>2: EM1</td><td>15: EME</td></tr> <tr><td>3: EM2</td><td>16: EMF</td></tr> <tr><td>4: EM3</td><td>17: EM10</td></tr> <tr><td>5: EM4</td><td>18: EM11</td></tr> <tr><td>6: EM5</td><td>19: EM12</td></tr> <tr><td>7: EM6</td><td>20: EM13</td></tr> <tr><td>8: EM7</td><td>21: EM14</td></tr> <tr><td>9: EM8</td><td>22: EM15</td></tr> <tr><td>10: EM9</td><td>23: EM16</td></tr> <tr><td>11: EMA</td><td>24: EM17</td></tr> <tr><td>12: EMB</td><td>25: EM18</td></tr> </table> </li> <li>When Protocol Setting Parameter Is Set to MCP4               <table border="0"> <tr><td>0: D data registers</td><td>3: ZR file registers*<sup>1</sup></td></tr> <tr><td>1: W link registers*<sup>1</sup></td><td>4 to 25: D data registers</td></tr> <tr><td>2: R file registers</td><td></td></tr> </table> </li> <li>When Protocol Setting Parameter Is Set to FXP4               <table border="0"> <tr><td>0: D data registers (DM data memory registers)</td><td>2: R expansion registers (FM file registers)</td></tr> <tr><td>1: None (W link registers)*<sup>1</sup></td><td>3 to 25: Do not use.</td></tr> </table>               Device names in parentheses are for Keyence KV-series PLCs.             </li> </ul>	0: DM	13: EMC	1: EM0	14: EMD	2: EM1	15: EME	3: EM2	16: EMF	4: EM3	17: EM10	5: EM4	18: EM11	6: EM5	19: EM12	7: EM6	20: EM13	8: EM7	21: EM14	9: EM8	22: EM15	10: EM9	23: EM16	11: EMA	24: EM17	12: EMB	25: EM18	0: D data registers	3: ZR file registers* <sup>1</sup>	1: W link registers* <sup>1</sup>	4 to 25: D data registers	2: R file registers		0: D data registers (DM data memory registers)	2: R expansion registers (FM file registers)	1: None (W link registers)* <sup>1</sup>	3 to 25: Do not use.	0
0: DM	13: EMC																																						
1: EM0	14: EMD																																						
2: EM1	15: EME																																						
3: EM2	16: EMF																																						
4: EM3	17: EM10																																						
5: EM4	18: EM11																																						
6: EM5	19: EM12																																						
7: EM6	20: EM13																																						
8: EM7	21: EM14																																						
9: EM8	22: EM15																																						
10: EM9	23: EM16																																						
11: EMA	24: EM17																																						
12: EMB	25: EM18																																						
0: D data registers	3: ZR file registers* <sup>1</sup>																																						
1: W link registers* <sup>1</sup>	4 to 25: D data registers																																						
2: R file registers																																							
0: D data registers (DM data memory registers)	2: R expansion registers (FM file registers)																																						
1: None (W link registers)* <sup>1</sup>	3 to 25: Do not use.																																						
First Address Upper Word	<i>AdRH</i>	0 to 99	0																																				
First Address Lower Word	<i>AdRL</i>	0 to 9999	0																																				

Note: 1 The First Address Upper Word and First Address Lower Word parameters together specify the first address.

- Example: (1) If the first address of the PLC is 123456, set the First Address Upper Word parameter to 12 and the First Address Lower Word parameter to 3456 in the E5□C.
- (2) If you use an area labeled with “\*1,” convert the first address of the PLC (hexadecimal) to a decimal number and set the decimal value in the E5□C.
- If the first address of the PLC is 12345, set the First Address Upper Word parameter to 7 and the First Address Lower Word parameter to 4565 in the E5□C.

- 2 Set the same first address in all of the E5□C Controllers (e.g., set the same value as the value that is set for the E5□C with communications unit number 0).

## Applicable PLC Memory Addresses

Protocol setting	Area	Applicable address range* <sup>2</sup>
Host Link (FINS)	DM	0 to 32767
	EM0 to EM18	
MC protocol (format 4)	D data registers	0 to 12287
	W link registers	0 to 8191 (1FFF hex)
	R file registers	0 to 32767
	ZR file registers	0 to 999999 (F423F hex)
Dedicated protocol (format 4)	D data registers	0 to 7999
	DM data memory registers* <sup>1</sup>	
	W link registers* <sup>1</sup>	0 to 16383 (3FFF hex)
	R expansion registers FM file registers* <sup>1</sup>	0 to 9999

\*1 These device names are for Keyence KV-series PLCs.

- \*2 The address ranges depend on the type of PLC. Refer to the manual for your PLC and set the first address within an applicable range. The last address that is used by the E5□C is calculated as follows:

Last address: First address + (highest communication unit number + 1) × 30 – 1

Example: The following example is for three E5□C Controllers (highest communications unit number = 2). The first address is set to 100.

Last address = 100 + 3 × 30 – 1 = 189

### 6-2-6 Receive Data Wait Time

The receive data wait time is the time that the E5□C waits for a response from the PLC (or, for component communications, from an E5□C slave). You can normally use the default setting.

If you change the receive data wait time, the time at which programless communications start will change after the power supply is cycled. Use the following formula to calculate the start time.

Start time = Approx. 1 s + Receive data wait time × 4

Example: For the default setting of 1,000 ms, the start time is approximately 5 s.

Communications Setting Level

Display condition: The Protocol Setting parameter must be set to *F $\bar{L}$ N $\bar{S}$* , *M $\bar{E}$ P $\bar{4}$* , or *F $\bar{X}$ P $\bar{4}$* , or the Protocol Setting parameter must be set to *C $\bar{M}$ P* and the Communications Unit No. parameter must be set to 0 (master).

Parameter name	Displayed characters	Setting range	Default
Receive Data Wait Time	<i>R<math>\bar{W}</math>R<math>\bar{E}</math></i>	100 to 9999 ms	1000 ms

### 6-2-7 Communications Node Number

Set the communications node number to the Host Link unit number for an OMRON PLC and to the station number for a Mitsubishi PLC.

You can normally use the default setting.

Communications Setting Level

Display condition: The Protocol Setting parameter must be set to *F $\bar{L}$ N $\bar{S}$* , *M $\bar{E}$ P $\bar{4}$* , or *F $\bar{X}$ P $\bar{4}$* .

Parameter name	Displayed characters	Setting range	Default
Communications Node Number	<i>U<math>\bar{N}</math>C<math>\bar{E}</math></i>	0 to 99	0

## 6-2-8 Upload Settings and Download Settings

There are 13 upload settings and 13 download settings.

Communications Setting Level

Display condition: The Protocol Setting parameter must be set to *F<sub>L</sub>N5*, *MCP4*, or *F<sub>X</sub>P4*.

Parameter name	Displayed characters	Setting range		Default
Upload Setting 1	<i>UP 1</i>	0 to 98	1	Communications Monitor
Upload Setting 2	<i>UP 2</i>		2	Status (Upper Word)
Upload Setting 3	<i>UP 3</i>		3	Status (Lower Word)
Upload Setting 4	<i>UP 4</i>		4	Status 2 (Upper Word)
Upload Setting 5	<i>UP 5</i>		6	Decimal Point Monitor
Upload Setting 6	<i>UP 6</i>		7	Process Value
Upload Setting 7	<i>UP 7</i>		8	Internal Set Point
Upload Setting 8	<i>UP 8</i>		11	Heater Current 1 Value Monitor
Upload Setting 9	<i>UP 9</i>		16	MV Monitor (Heating)
Upload Setting 10	<i>UP 10</i>		0	Nothing assigned.
Upload Setting 11	<i>UP 11</i>		0	Nothing assigned.
Upload Setting 12	<i>UP 12</i>		0	Nothing assigned.
Upload Setting 13*	<i>UP 13</i>		0	Nothing assigned.
Download Setting 1	<i>DN 1</i>	30 to 98	31	Set Point
Download Setting 2	<i>DN 2</i>		61	Proportional Band
Download Setting 3	<i>DN 3</i>		62	Integral Time
Download Setting 4	<i>DN 4</i>		63	Derivative Time
Download Setting 5	<i>DN 5</i>		32	Alarm Value 1
Download Setting 6	<i>DN 6</i>		33	Alarm Value Upper Limit 1
Download Setting 7	<i>DN 7</i>		34	Alarm Value Lower Limit 1
Download Setting 8	<i>DN 8</i>		35	Alarm Value 2
Download Setting 9	<i>DN 9</i>		36	Alarm Value Upper Limit 2
Download Setting 10	<i>DN 10</i>		37	Alarm Value Lower Limit 2
Download Setting 11	<i>DN 11</i>		45	Heater Burnout Detection 1
Download Setting 12	<i>DN 12</i>		57	Process Value Input Shift
Download Setting 13	<i>DN 13</i>		75	SP Ramp Set Value

\* This parameter cannot be used when the Protocol Setting parameter is set to *F<sub>X</sub>P4*.

### ● Example of Changing a Setting:

To set the Alarm Value 3 parameter for Download Setting 11, you would change the set value from 45 (Heater Burnout Detection 1) to 38 (Alarm Value 3).

You can use the settings in the following table for the upload settings and download settings.

Set value		Set value		
Upload settings (Cannot be used for download settings.)	0	Nothing assigned.	Upload or Download Settings	
	1	Communications Monitor		
	2	Status (Upper Word)		
	3	Status (Lower Word)		
	4	Status 2 (Upper Word)		
	5	Status 2 (Lower Word)		
	6	Decimal Point Monitor		
	7	Process Value		
	8	Internal Set Point		
	9	Multi-SP No. Monitor		
	10	Remote SP Monitor		
	11	Heater Current 1 Value Monitor		
	12	Heater Current 2 Value Monitor		
	13	Leakage Current 1 Monitor		
	14	Leakage Current 2 Monitor		
	15	Soak Time Remain		
	16	MV Monitor (Heating)		
	17	MV Monitor (Cooling)		
	18	Valve Opening Monitor		
19	Spare			
...	...	54	SP 5	
Upload or Download Settings	30	Nothing assigned.	55	SP 6
	31	Set Point	56	SP 7
	32	Alarm Value 1	57	Process Value Input Shift
	33	Alarm Value Upper Limit 1	58	Process Value Slope Coefficient
	34	Alarm Value Lower Limit 1	59	Remote SP Input Shift
	35	Alarm Value 2	60	Remote SP Input Slope Coefficient
	36	Alarm Value Upper Limit 2	61	Proportional Band
	37	Alarm Value Lower Limit 2	62	Integral Time
	38	Alarm Value 3	63	Derivative Time
	39	Alarm Value Upper Limit 3	64	Proportional Band (Cooling)
	40	Alarm Value Lower Limit 3	65	Integral Time (Cooling)
	41	Alarm Value 4	66	Derivative Time (Cooling)
	42	Alarm Value Upper Limit 4	67	Dead Band
	43	Alarm Value Lower Limit 4	68	Manual Reset Value
	44	Manual MV	69	Hysteresis (Heating)
	45	Heater Burnout Detection 1	70	Hysteresis (Cooling)
	46	Heater Burnout Detection 2	71	Soak Time
	47	HS Alarm 1	72	Wait Band
	48	HS Alarm 2	73	MV at Stop
	49	SP 0	74	MV at PV error
	50	SP 1	75	SP Ramp Set Value
	51	SP 2	76	SP Ramp Fall Value
	52	SP 3	77	MV Upper Limit
	53	SP 4	78	MV Lower Limit
			79	MV Change Rate Limit
			80	Extraction of Square Root Low-cut Point
			81	Work Bit 1 ON Delay
			82	Work Bit 1 OFF Delay
			83	Work Bit 2 ON Delay
			84	Work Bit 2 OFF Delay
			85	Work Bit 3 ON Delay
			86	Work Bit 3 OFF Delay
			87	Work Bit 4 ON Delay
			88	Work Bit 4 OFF Delay
		89	Work Bit 5 ON Delay	
		90	Work Bit 5 OFF Delay	
		91	Work Bit 6 ON Delay	
		92	Work Bit 6 OFF Delay	
		93	Work Bit 7 ON Delay	
		94	Work Bit 7 OFF Delay	
		95	Work Bit 8 ON Delay	
		96	Work Bit 8 OFF Delay	
		97	Position Proportional Dead Band	
		98	Open/Close Hysteresis	

- Note: 1 If nothing is assigned for an upload setting, the corresponding address in the upload area will contain 0. If nothing is assigned for a download setting, nothing will be done in the download area.
- 2 If the same value is set for more than one download setting, only the download setting with the lower number will be valid. The other download setting will be treated as if nothing was assigned. All upload settings are valid even if the same value is set more than once.



## 6-2-9 Copying Parameter Settings

You can copy the settings of all parameters except for the Communications Unit No. parameter from the master (i.e., the Controller with communications unit number 0) to one or more of the slaves (i.e., the Controllers with communications unit numbers other than 0). Copying parameters is possible only between Controllers with the same model number and the same version. All of the slaves are automatically reset after the copying operation is completed. Make sure that the system will not be adversely affected before you copy parameter settings.

<b>Case in which copying is possible</b>	The model numbers and versions are the same. Example: E5CC-RX2ASM-002(V1.1) → E5CC-RX2ASM-002(V1.1)
<b>Cases in which copying is not possible</b>	The model numbers are different. Example: E5CC- <del>R</del> X2ASM-002 → E5CC- <del>Q</del> X2ASM-002
	The versions are different. Example: E5CC-RX2ASM-002(V1. <del>1</del> ) → E5CC-RX2ASM-002(V1. <del>0</del> )

### Communications Setting Level

Display condition: The Protocol Setting parameter must be set to *EMP*, *FLNS*, *MCP4*, or *FXP4* and the Communications Unit No. parameter must be set to 0 (master).

Parameter name	Displayed characters	Setting range	Default
Copy	<i>COPY</i>	<i>OFF</i> (Copying failed: <i>EO**</i> ) <i>ALL</i> 1 to 31	<i>OFF</i>

## Copying Procedure Starting from the Initial Status

- (1) Connect the master and slaves with RS-485 connections and turn ON the power supply.
- (2) Set the Communications Unit No. parameters of the slaves in order starting from 1 and then return to the operation level.
- (3) Set all of the parameters in the master except for those in the communications setting level.
- (4) Change the master to the communications setting level and change the communications settings as given below.

Change the Protocol Setting parameter, set the Communications Unit No. parameter to 0, set the Communications Baud Rate parameter to 19.2 for a Mitsubishi FX1 or FX2 PLC, 38.4 for a Mitsubishi FX3 PLC, and 57.6 for any other PLC, set the Send Data Wait Time parameter to 1, and set the Highest Communications Unit No. parameter to the highest communications unit number that is set.

Change the other parameters in the communications setting level as required.

Do not return to the operation level while you are changing the parameter settings. If you mistakenly return to the communications setting level, return the Communications Baud Rate parameter to 9.6, return to the operation level, and then set the Communications Baud Rate parameter again.

**(5) COPY and execute the copy operation.**

If you select ALL, the parameters settings will be copied to all of the slaves. If you select a number, the parameters settings will be copied to the slave with the selected communications unit number.

Set value	Description
OFF (E0**)	Copying is not in progress. The display will automatically return to OFF when the copy operation is completed normally.  If the copy operation fails, ** will be displayed instead of OFF. The asterisks will be replaced with the communications unit number of the slave where copying failed. This value will be maintained until the copy operation is completed normally or until you return to the operation level. Example: If copying failed at the slave with communications unit number 2, E002 will be displayed.
ALL	The parameter settings are copied to the slaves starting with the slave with communications unit number 1 and continuing on to the slave with the communications unit number that is set in the Highest Communications Unit No. parameter. When copying is started, the PV display on the slave will change to COPY. The copying operation is completed when all of the slaves are reset.
1 to 31	The parameter settings are copied to the slave with the specified communications unit number, and then all of the slaves are automatically reset.

Note: 1 You cannot cancel copying once the copying operation has been started. Even if you change the set value during the copying operation, the current processing will be continued.

2 If copying fails, the copying operation will be aborted and the parameter settings will not be copied to the remaining slaves.

For a Mitsubishi PLC, the ERR. indicator on the Serial Communications Module will light during the copying process, but this does not indicate an error. The ERR. indicator will go out when the PLC is restarted.

Refer to 6-4-4 E5@C Controller Setup for specific copying procedures.

**Troubleshooting**

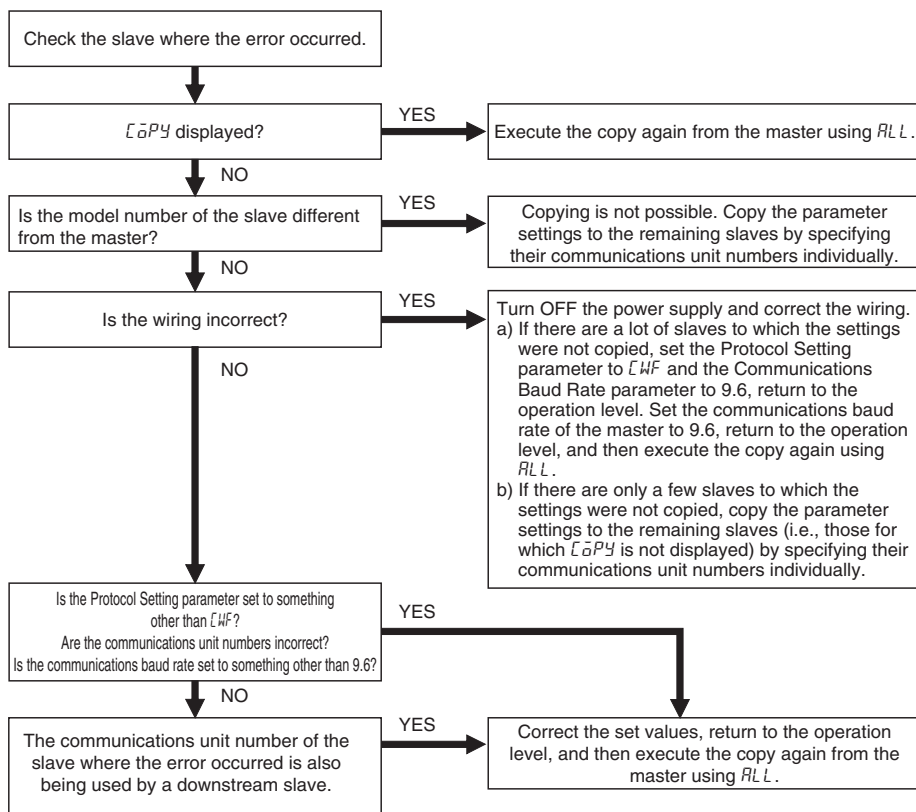

- Note: 1 If you cycle the power supply to the E5□C Controllers after the error occurs, perform procedure “a” given above.
- 2 If you cannot solve the problem with the above flowchart or if the situation becomes too confusing, cycle the power supply to all of the E5□C Controllers and then perform procedure “a” given above to copy the parameter settings to all of the slaves.

## Copying Procedure When Replacing a Controller

### ● Replacing a Slave (i.e., a Controller with a Communications Unit Number Other Than 0)

- (1) Replace the E5□C, wire it, and then turn ON the power supply.
- (2) Change all of the E5□C Controllers to the initial setting level and stop programless communications. The above step is not required for component communications.
- (3) Set the Communications Unit No. parameter and Communications Baud Rate parameter (to 19.2 for a Mitsubishi FX1 or FX2 PLC, 38.4 for a Mitsubishi FX3 PLC, and 57.6 for any other PLC) in the new E5□C Controller and then return to the operation level.
- (4) Copy the parameter set values from the master to the new E5□C Controller by specifying the number of the Controller.
- (5) Return all of the slaves and the master in order to the operation level. This completes the replacement. The above step is not required for component communications.

### ● Replacing the Master (i.e., the Controller with a Communications Unit Number of 0)

To copy the parameter settings, one of the slaves will function as the master, which means that the No. 0 Upload Area and the No. 1 Upload Area will temporarily change in PLC memory. Turn OFF the power supply to the PLC or otherwise make sure that the system will not be adversely affected before you perform the following procedure.

- (1) Perform steps 1 and 2 in the above procedure.
- (2) Record the communications unit number and communications baud rate of the slave with communications unit number 1, and then temporarily change the communications unit number to 0 (master). Do not return to the operation level after you change the communications unit number.
- (3) Set the Communications Unit No. parameter and the Communications Baud Rate parameter of the new E5□C to the values that you recorded, and then change to the operation level.
- (4) Copy the parameter settings from the temporary master, specifying the communications unit number of the new E5□C.
- (5) Reverse the communications unit numbers of the temporary master and the new E5□C.
- (6) Return all of the slaves and the master in order to the operation level. This completes the replacement. The above step is not required for component communications.

## 6-2-10 Communications Writing

Writing can be enabled and disabled from the PLC (or, for component communications, from the E5□C master). The Communications Writing parameter is normally left ON (enabled). However, if it is necessary to change set values from the display section of the E5□C in an emergency, temporarily change the setting to OFF (disabled). If you disable communications when writing is being performed from the

PLC, an error will occur in the PLC. (An error code will be set in the Response Flag in PLC memory.) If you cycle the power supply to the E5□C or move to the initial setting level and then go back to the operation level, the Communications Writing parameter will automatically change to ON.

### 6-2-11 Communications Monitor Parameter

This parameter displays the communications cycle time of the E5□C. If communications with the PLC are not possible, *∟ERR* is displayed and then the cycle time is displayed again when communications are restored.

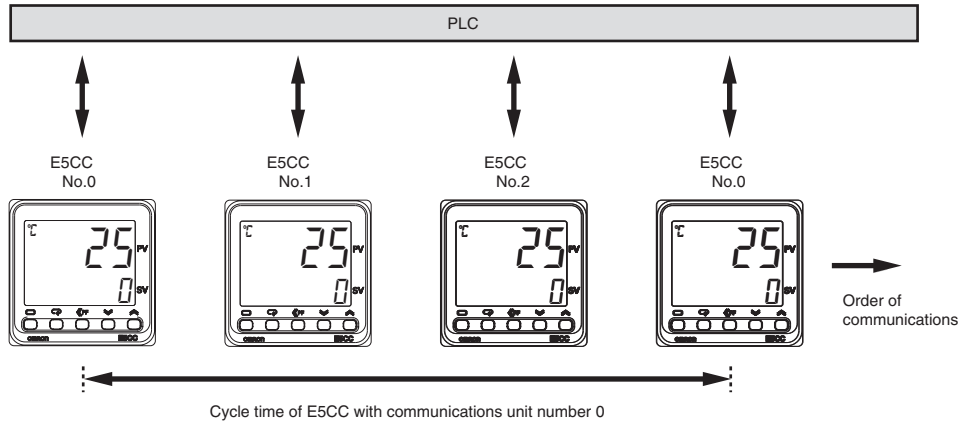

#### Adjustment Level

Display condition: The Protocol Setting parameter must be set to *F∟NS*, *M∟P4*, or *F×P4*.

Parameter name	Displayed characters	Monitor range*	Default
Communications Monitor	<i>PL∟M</i>	Normal operation: 0 to 9999 ms. If 9,999 ms is exceeded, ∟∟∟∟ is displayed. Error: <i>∟ERR</i>	---

Note: If this parameter is monitored in PLC memory, the cycle time is given as 0 to FFFF hex (0 to 65,535 decimal). An error is indicated by FFFF hex.

## 6-3 Controlling Programless Communications

The section describes the methods that are used to control programless communications from the PLC.

### 6-3-1 Controlling Programless Communications with the Request Flag

There are the following three ways to control programless communications. The Request Flag in PLC memory is used to change the control method.

#### 1. Updating Monitor Values (Disable Writing Request)

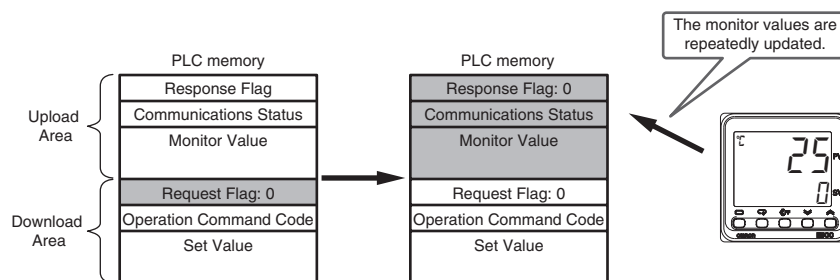

If you set the Request Flag to 0, the Response Flag will change to 0 and the monitor values will be updated.

#### 2. Writing Set Values and Updating Monitor Values (Enable Writing Request)

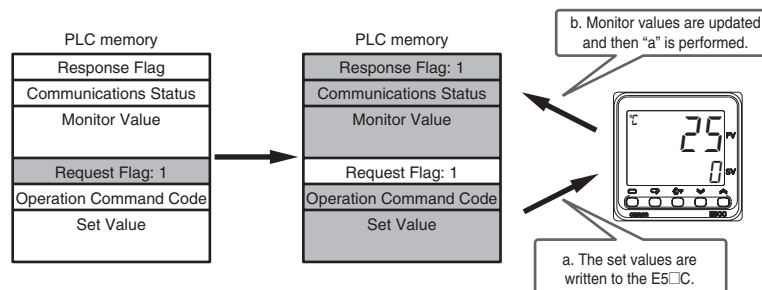

If you set the Request Flag to 1, the set values will be written to the E5□C and then the operation command will be written to the E5□C. Finally the Response Flag will change to 1 and the monitor values will be updated. The operation command is processed only the first time, but the set values are written each time. Therefore, you cannot change the parameters that are specified for download settings at the E5□C. To change parameters that are specified for download settings at the E5□C, refer to 6-2-10 *Communications Writing*.

#### 3. Initializing the Download Area

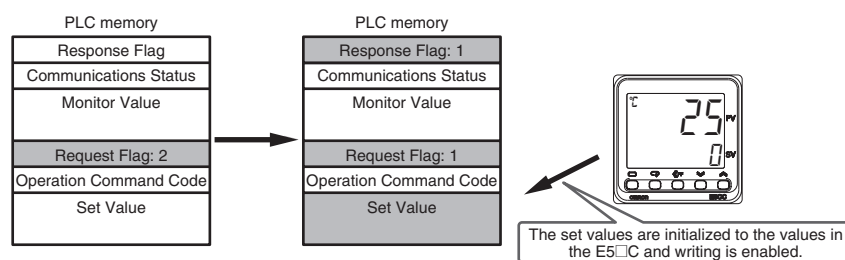

If you set the Request Flag to 2, the set values in the download area will be initialized to the values from the E5□C and then the Request Flag and Response Flag will change to 1. Finally, the operation described above for control method 2 is performed.

### 6-3-2 Response Flag

The Response Flag changes as shown below for the values of the Request Flag.

Request Flag	Response Flag	
	Normal	Error
0: Disable Writing	0 *	EEEE
1: Enable Writing	1	EDD 1 to ED 13 8000 or Operation Command Code
2: Initialize Download Areas	1	EEEE

\* If a communications error prevents reading data for the Request Flag, the Response Flag will change to EEEE.

Response Flag at error	Cause of error
EEEE	There was no response or a communications error occurred when reading the download area.
EDD 1 to ED 13 *1	<ul style="list-style-type: none"> <li>The write data is out of the setting range.</li> <li>The Communications Writing parameter is set to OFF.</li> </ul>
8000 (hex) or Operation Command Code *2	<ul style="list-style-type: none"> <li>The operation command code is incorrect.</li> <li>The current status of the E5□C prevents it from acknowledging the operation command.</li> <li>The Communications Writing parameter is set to OFF.</li> </ul>

\*1 The Response Flag gives the number of the download setting where the error occurred. If more than one error occurs, the largest number is given first. When the error is cleared, the next error number is given. Writing the remaining data is continued even if an error occurs during communications.

Example: If errors occur for download settings 10 and 12, the Response Flag will be ED 12.

\*2 An OR of 8000 and the operation command code is given. If a setting range error occurs at the same time, indicating the operation command error will be given priority.

Example: If an error occurs for operation command code 1101, the Response Flag will be 9 10 1.

#### ● Precautions for AT (Auto-tuning)

Do not change the set values in the download area from the start of auto-tuning until auto-tuning is completed or canceled. Programless communications cannot be used to change the set values of the E5□C after auto-tuning starts. Also, if the Request Flag is set to 1 (Enable Writing) at the completion of auto-tuning, the set values in the download area are initialized to the set values from the E5□C. This is to update the PID constants. (It occurs even if PID constants are not set in the download area.) To prevent initialization, change the Request Flag to 0 (Disable Writing) after auto-tuning starts. If you change the Request Flag to 1 (Enable Writing) after the completion of auto-tuning, the values in PLC memory will be written to the E5□C. If you change the Request Flag to 2 (Initialize Download Areas) after the completion of auto-tuning, the download area will be initialized with the set values from the E5□C.

#### ● Precautions for ST (Self-tuning)

If you use self-tuning and set PID constants in the download area, always leave the Request Flag set to 1 (Enable Writing).\* If you change the Request Flag from 0 (Disable Writing) to 1 (Enable Writing) during operation, the PID constants that were found with self-tuning will be overwritten with the values from PLC memory.

\* You can change the Request Flag to 2 (Initialize Download Areas) at the start of programless communications.

### 6-3-3 Range of Operation for Programless Communications

Programless communications start operating after the power supply is turned ON or after the E5□C is reset. They stop operating when the initial setting level is entered.

Levels	Setting area	Programless communications
Operation level, adjustment level, manual control level, monitor/setting item level, and protect level	Setting area 0	Operates
Initial setting level, communications setting level, advanced function setting level, and calibration level	Setting area 1	Stops

### 6-3-4 Operation Command Codes

The following table gives the operation command codes that can be set. For details on operation commands, refer to 2-3-8 *Operation Command*.

Operation command	Operation command code	Switch
RUN/STOP	0100	RUN
	0101	STOP
Multi-SP	0200	SP 0
	0201	SP 1
	0202	SP 2
	0203	SP 3
	0204	SP 4
	0205	SP 5
	0206	SP 6
	0207	SP 7
AT Execute/Cancel	0300	AT Cancel
	0301	100% AT Execute
	0302	40% AT Execute
Write Mode	0400	Backup Mode
	0401	RAM Write Mode
Save RAM Data	0500	Save RAM Data
Software Reset	0600	Software Reset
Auto/Manual	0900	Automatic Mode
	0901	Manual Mode
Alarm Latch Cancel	0C00	Alarm 1 Latch Cancel
	0C01	Alarm 2 Latch Cancel
	0C02	Alarm 3 Latch Cancel
	0C03	Heater Burnout Latch Cancel
	0C04	HS Alarm Latch Cancel
	0C05	Alarm 4 Latch Cancel
	0C0F	All Latch Cancel
SP Mode	0D00	Local SP Mode
	0D01	Remote SP Mode
Invert Direct/Reverse Operation	0E00	Do Not Invert
	0E01	Invert
Program Start	1100	Reset
	1101	Start

### 6-3-5 Confirming Operation of Programless Communications

You can check the operation of programless communications in the Communications Status in the upload area.

The value of the Communications Status changes between 0 and 1 each time the upload area is updated.

### 6-3-6 Write Mode

The E5□C normally writes the set values to non-volatile memory (i.e., in Backup Mode). If you frequently change set values with programless communications, use an operation command to change to RAM Write Mode.

In RAM Write Mode, however, the set values will be restored to the values in non-volatile memory every time the power supply is cycled. If you need to maintain the current set values before the power supply is turned OFF, use an operation command to save them to RAM before the power supply turns OFF.

### 6-3-7 Troubleshooting

Possible problems that can occur with programless communications and corrective actions are given in the following table.

Status	Cause and corrective action	Page
The Response Flag changes to <i>E0**</i> .	The write value for the set value for download setting ** is out of range.	3-3 to 3-7
	The Communications Writing parameter is set to OFF.	6-15
The Response Flag changes to 8*** (hex) or 9*** (hex).	The operation command code is incorrect.	6-19
	The current status of the E5□C prevents it from acknowledging the operation command.	2-17 to 2-20
	The Communications Writing parameter is set to OFF.	6-15
The Response Flag changes to <i>EEEE</i> .	The power supply to the E5□C Controllers was turned ON before the power supply to the PLC.	6-4
	The PLC memory address is out of range.	6-8
	There may be noise interference. Shield the communications line or attach terminating resistance to the end of the communications line.	6-22 6-33 6-38
<ul style="list-style-type: none"> <li>The communications indicator on the PLC flashes irregularly.</li> <li>The value of the Communications Monitor parameter in the E5□C is too long.</li> </ul>	The Highest Communications Unit No. parameter is not set to the highest communications unit number that is actually set.	6-7
	<ul style="list-style-type: none"> <li>Communications unit numbers are not set consecutively from 0 or the same communications unit number is set more than once.</li> <li>The setting of the Communications Baud Rate parameter is not the same for all E5□C Controllers.</li> </ul>	6-7
	The E5□C was moved to the initial setting level (setting area 1).	6-19
<ul style="list-style-type: none"> <li>The communications indicator on the PLC is not lit.</li> <li>The Communications Monitor parameter in the E5□C is <i>ERR</i>.</li> </ul>	The power supply is not turned ON to the E5□C Controller with communications unit number 0.	6-4
	The wiring is not correct.	6-22 6-33 6-38
	The communications settings are not the same between the PLC and the E5□C.	6-22 6-33 6-38 6-25
	The E5□C was moved to the initial setting level (setting area 1).	6-19
	Check the cycle time of the PLC. If it is longer than the value set for the Receive Data Wait Time parameter, change the set value of this parameter so that it is longer than the cycle time.	6-10
	The ERR. indicator on the Serial Communications Module is lit (for a Mitsubishi PLC).	The power supply to the E5□C Controllers was not turned ON or OFF at the proper time.

Note: For information on other problems, refer to *A-2 Troubleshooting*.



## 6-4 Connecting to CP-series PLCs

### 6-4-1 Configuration and Procedure

The following configuration is used as an example in giving the setup and application procedures for programless communications.

- All of the E5CC Controllers must be the same model. (Copying parameter settings is not possible if the models are different.)
- D0000 to D0089 are used in the PLC memory. The default E5CC parameter allocations are used.
- A commercially available USB2.0, A/B cable is used.

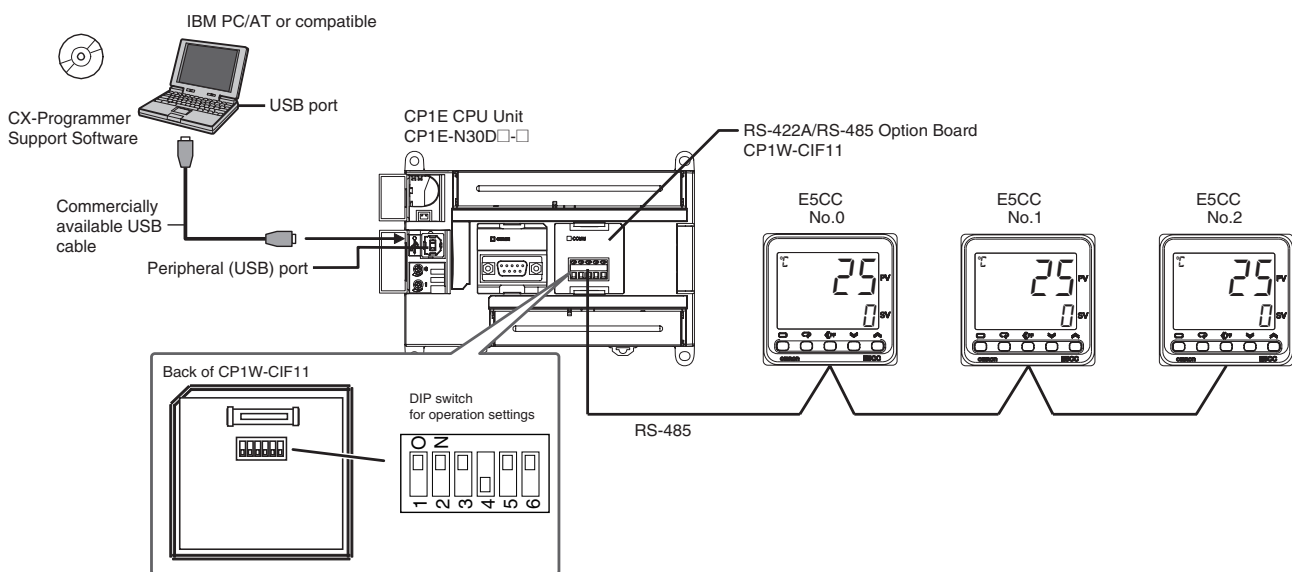

Note: Refer to the *CX-Programmer Operation Manual* (Cat. No. W446) for information on installing the CX-Programmer and USB driver.

The application procedure is given below.

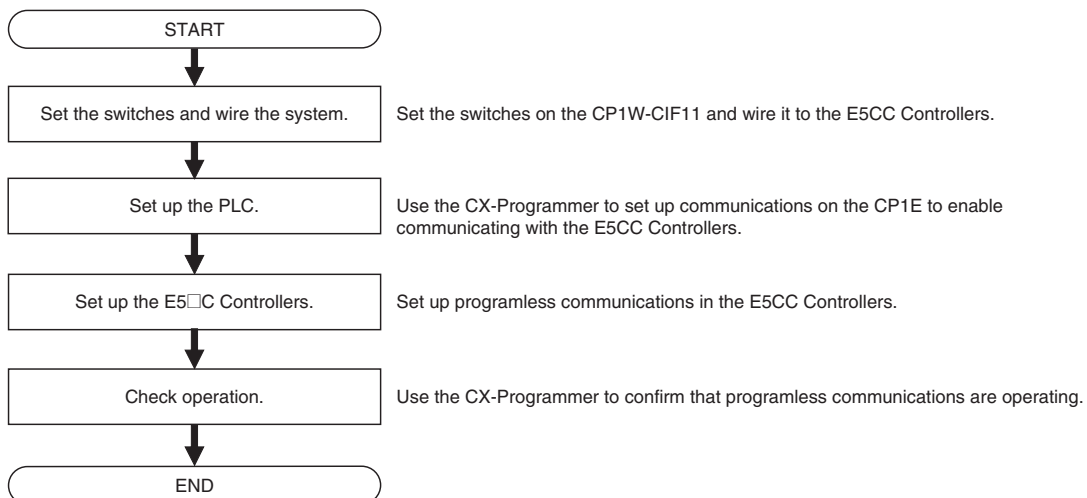

### 6-4-2 Switch Settings and Wiring

Before you attach the CP1W-CIF11 to the CP1E, turn OFF pin 4 on the DIP switch for operation settings on the back of the CP1W-CIF11 and turn ON the rest of the pins.

Pin	OFF	ON	Setting
1	No terminating resistance	Terminating resistance on both ends	Terminating resistance selection
2	4-wire	2-wire	2-wire or 4-wire selection
3	4-wire	2-wire	Same as above.
4	---	---	Not used.
5	RS control disabled. (Signal always received.)	RS control enabled.	RS control selection for RD
6	RS control disabled. (Signal always sent.)	RS control enabled.	RS control selection for SD

Wire the CP1W-CIF11 to the E5CC Controllers as shown below.

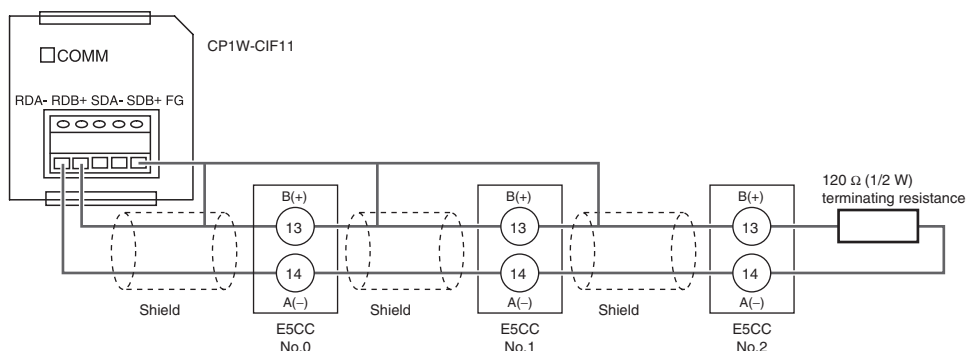

- Note: 1 The maximum transmission distance is 50 m for the CP1W-CIF11 and 500 m for the CP1W-CIF21.  
 2 For wiring methods, refer to A-3-2 Recommended RS-422A/485 Wiring in the CP1E CPU Unit Hardware User's Manual (Cat. No. W479).

### 6-4-3 PLC Setup

Set up communications on the CP1E to enable communicating with the E5CC Controllers. PLC operation will stop and the power supply will be cycled during the setup procedure. Make sure that this will not create any problems in the controlled system.

● **Connecting to the PLC**

- (1) Connect the computer to the CP1E with a USB cable and then start the CX-Programmer.
- (2) Select **PLC – Auto Online – Direct Online** from the menu bar.

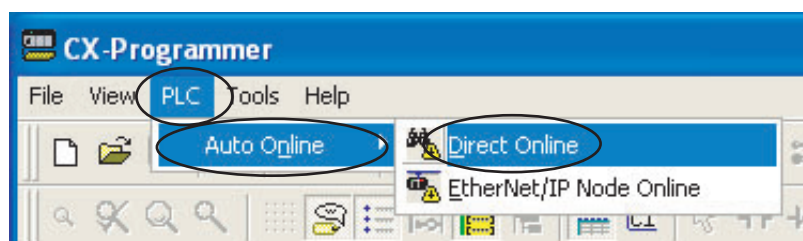

- (3) Select the **USB connection** Check Box and click the **Connect** Button.

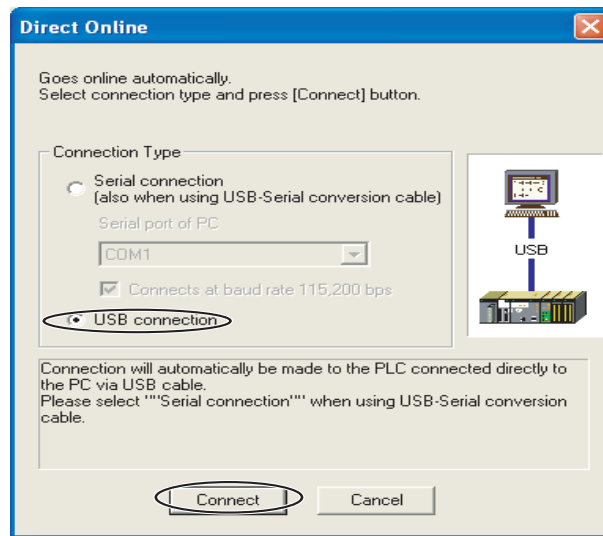

- (4) Select the **Transfer IO table and Special Unit Setup** Check Box and click the **Yes** Button.

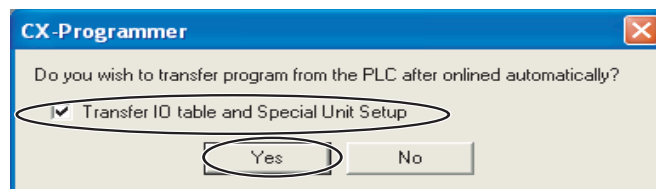

- (5) After the data has been transferred, click the **OK** Button.

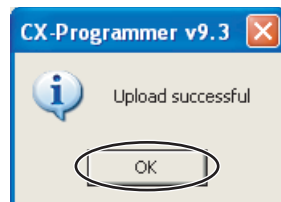

## Communications Settings for the Serial Communications Option Board

- (1) The PLC operating mode must be changed to PROGRAM mode to enable changing the communications settings in the PLC Setup.

Select *PLC – Operating Mode – Program* from the menu bar. A confirmation dialog box will be displayed. Click the Yes Button.

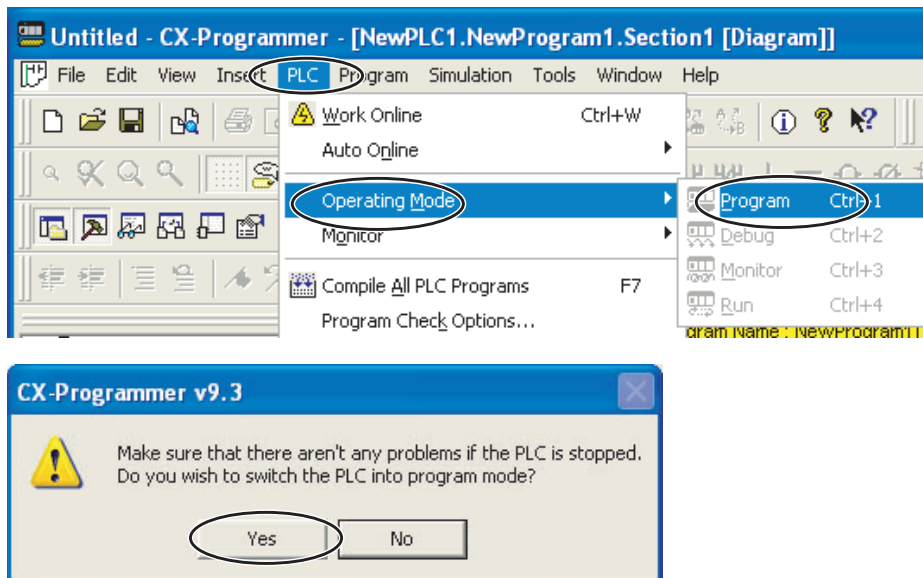

- (2) Double-click Settings. The PLC Setup Window will be displayed.

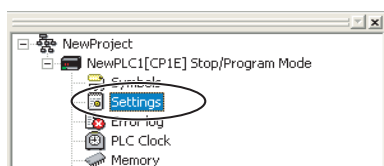

- (3) Click the Serial Option Port Tab, select the *Custom* Option, and set the baud rate to 57,600. Leave the other settings at their default values.

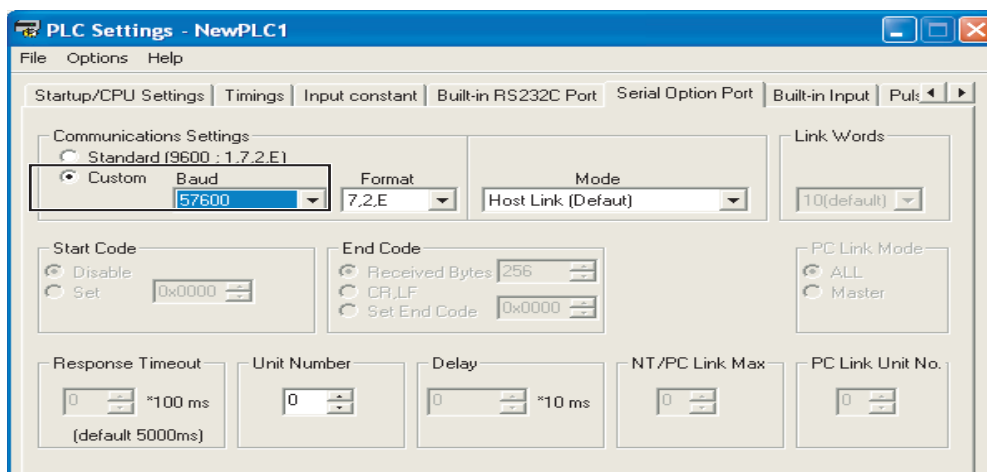

Note: If you change the unit number, refer to 6-2-7 Communications Node Number.

- (4) Select *Options – Transfer to PLC* from the menu bar in the window that is shown above. The settings will be transferred.

Close the window and cycle the power to the PLC. This completes the PLC setup procedure. You will use the CX-Programmer to check operation, so leave it online.

#### 6-4-4 E5□C Controller Setup

This section describes the setup for programless communications (or components communications). Refer to 6-2 *E5@C Setup* for the procedure to display parameters. (Refer to 7-1-3 *E5@C Setup* for component communications as well.) Here we will assume that all parameters other than those for communications have already been set. Make sure that all of the E5□C Controllers are the same model. The parameter settings cannot be copied if the models are different.

- (1) Set the **Communications Unit No. parameter ( $U-N\bar{o}$ )** in the communications setting level to 1 for the No. 1 Controller and set it to 2 for the No. 2 Controller. Leave the other communications settings at their default values.

The default communications unit number is 1, so the Communications Unit No. parameter for the No. 1 Controller does not need to be changed.

Always set the communications unit numbers of the slaves in order from 1.

To enable the changes to the settings, always return to the operation level.

- (2) Change the parameter settings in the communications setting level of the No. 0 Controller to the values that are given below.

Protocol Setting ( $PSEL$ ):  $F\bar{L}NS$  (Set  $MCPY$  for a Mitsubishi Q-series or L-series PLC,  $FxPY$  for a Mitsubishi FX-series or Keyence KV-series PLC, and  $LMP$  for component communications.)

Communications Unit No. ( $U-N\bar{o}$ ) : 0

Communications Baud Rate ( $bPS$ ): 57.6 (Set 19.2 for a Mitsubishi FX1 or FX2 PLC and set 38.4 for a Mitsubishi FX3 PLC.)

Send Data Wait Time ( $SdWT$ ): 1

Highest Communications Unit No. ( $MAXU$ ): 2

Do not return to the operation level even after you finish making the settings.

Here we will assume that all parameters other than those for communications have already been set. If parameters other than those for communications need to be set, change them first and then change the communications settings last.

- (3) Perform the following procedure to copy the parameter settings in the No. 0 Controller to the No. 1 and No. 2 Controllers.

(a) Display the  $L\bar{o}PY$  parameter in the communications setting level on the No. 0 Controller.

(b) Press the Up Key to select  $ALL$  and wait for three seconds. The completion of the copy operation must be confirmed, so do not move to any other levels or parameters. If you do change to any other levels or parameters, display the  $L\bar{o}PY$  parameter again.

(c) The PV displays on the No. 1 and No. 2 Controllers will change to  $L\bar{o}PY$  and then these Controllers will be reset.

- (d) Confirm that the setting of the  $\overline{\text{COPY}}$  parameter on the No. 0 Controller changes to  $\overline{\text{OFF}}$  (i.e., copying completed), and then return the No. 0 Controller to the operation level.
- (e) Programless communications should now be operating. Confirm that the COMM indicator on the CP1W-CIF11 is flashing.

If you are using the CJ1W-SCU21-V1, the SD1 and RD1 indicators will flash. If you are using the QJ71C24N-R4, the SD and RD indicators for channel 1 (CH1) will flash.

If you are using component communications, change the SPs in the master and confirm that the SPs of the slaves change to the same values.

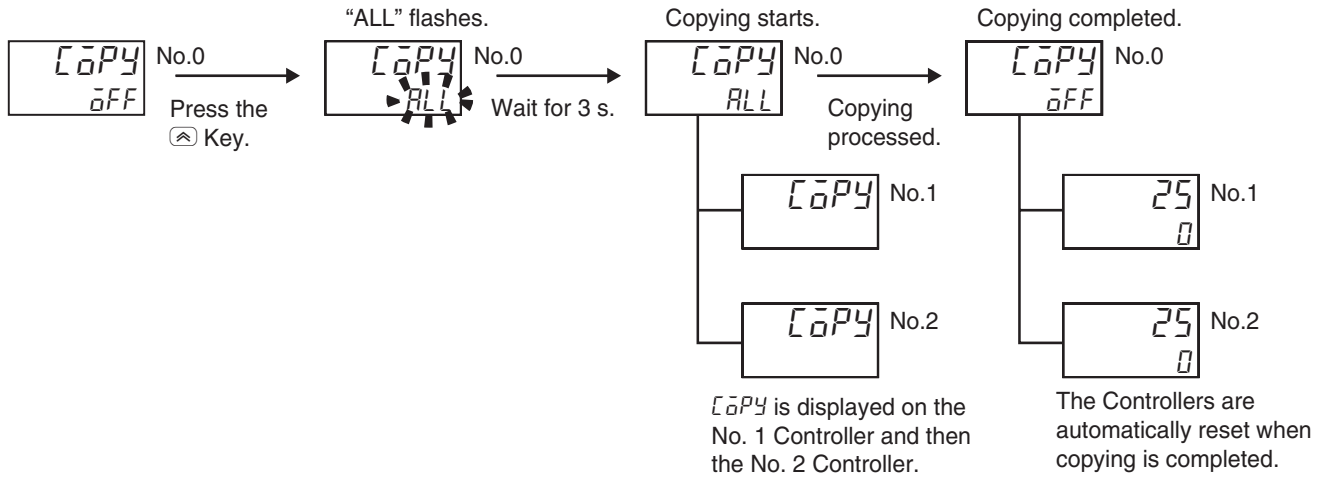

CP1W-CIF11

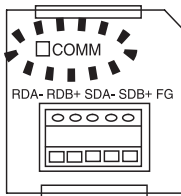

CJ1W-SCU21-V1

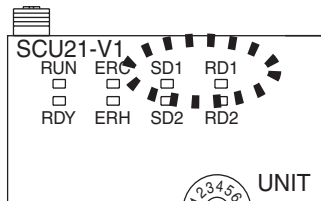

QJ71C24N-R4

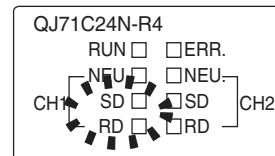

For a Mitsubishi PLC, the ERR. indicator on the Serial Communications Module will light during the copying process. Ignore it and check the operation. The ERR. indicator will go out when the PLC is restarted.

Note: Refer to 6-2-9 Copying Parameter Settings for details on the copying operation.

### 6-4-5 Checking Operation

The SP and RUN/STOP status of the E5□C Controllers will be changed to check operation. Make sure that this will not create any problems in the controlled system.

#### ● Checking E5CC Monitor Values

- (1) **The PLC operating mode must be changed to PROGRAM mode to enable changing values in PLC memory.**

Perform step 1 in *Communications Settings for the Serial Communications Option Board* in 6-4-3 PLC Setup to move to PROGRAM mode.

- (2) **Double-click Memory. The PLC Memory Window will be displayed.**

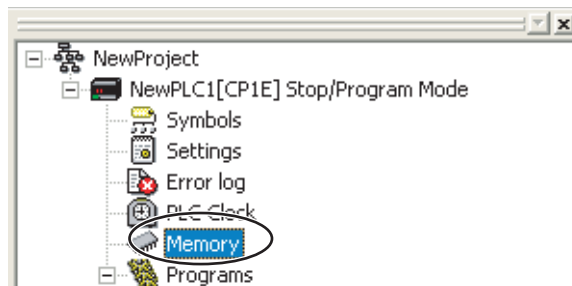

- (3) **We will monitor memory in the PLC Memory Window.**

Double-click **D** to select the DM Area in the left pane and then select **Online – Monitor** from the menu bar. The Monitor Memory Areas Dialog Box will be displayed. Click the **Monitor** Button.

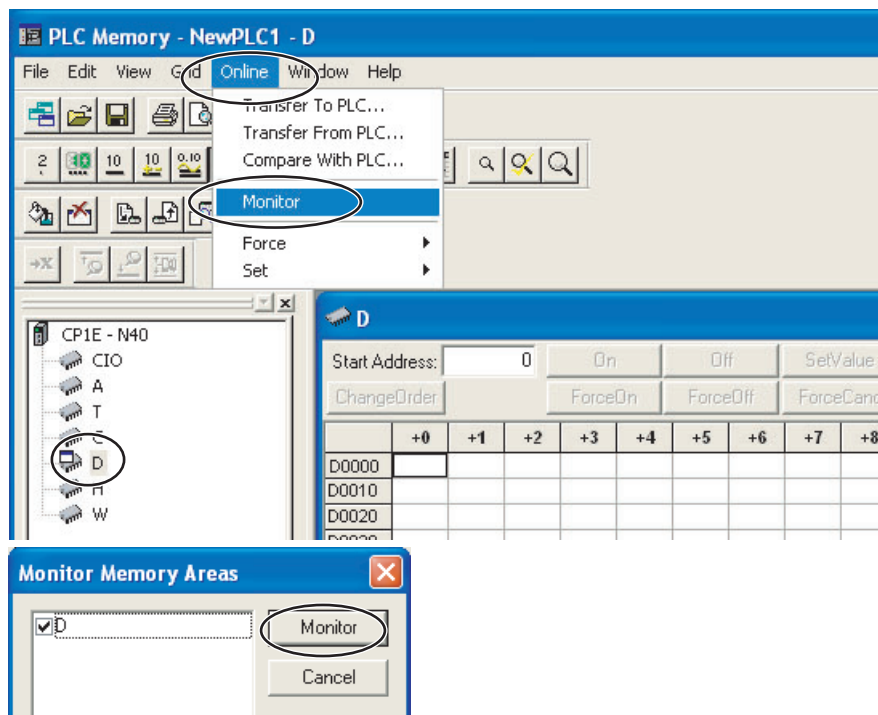

- (4) We will change the values that are displayed for PLC memory to signed decimal values.

Select **View – Display – Signed Decimal** from the menu bar. You can select **View – Display – Hexadecimal** to return the display to hexadecimal values.

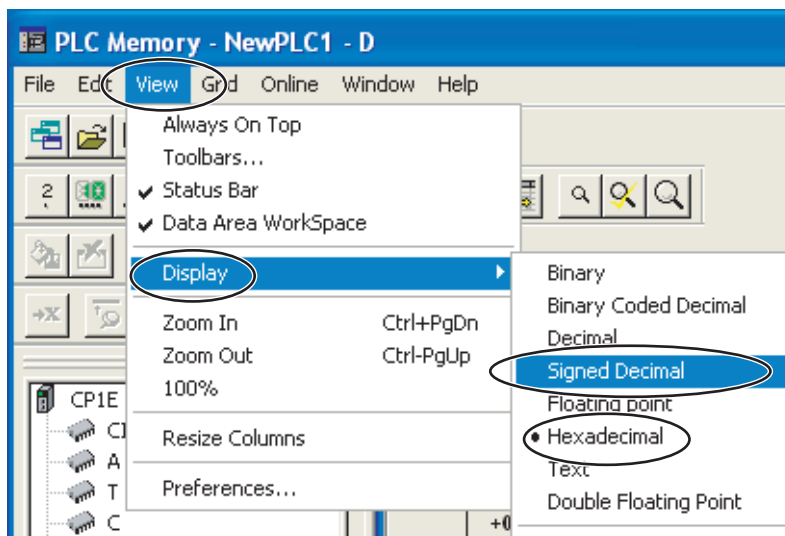

- (5) We will check the E5CC monitor values.

The area where monitor values are checked is called the upload area.

D0000 to D0014 is the upload area for the No. 0 Controller, D0030 to D0044 is the upload area for the No. 1 Controller, and D0060 to D0074 is the upload area for the No. 2 Controller.

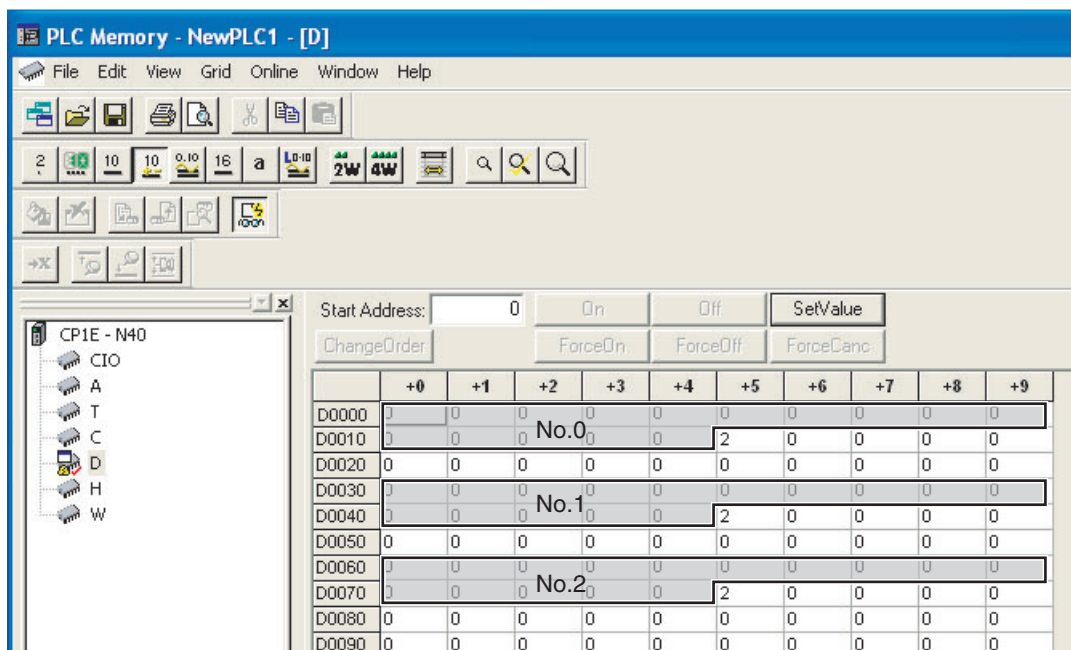



With the default settings, the following parameters are set for the upload areas. Check the values in the upload areas to see if they are the same as those that are given in the following table. (It is not necessary to check addresses for which “---” is given in the Value column.)

No.0	No.1	No.2	Parameter	Value
D0000	D0030	D0060	Response Flag (fixed)	0
D0001	D0031	D0061	Communications Status (fixed)	Alternates between 0 and 1.
D0002	D0032	D0062	Communications Monitor	---
D0003	D0033	D0063	Status (Upper Word)	---
D0004	D0034	D0064	Status (Lower Word)	---
D0005	D0035	D0065	Status 2 (Upper Word)	---
D0006	D0036	D0066	Decimal Point Monitor	---
D0007	D0037	D0067	Process Value	Process Value *
D0008	D0038	D0068	Internal Set Point	---
D0009	D0039	D0069	Heater Current 1 Value Monitor	---
D0010	D0040	D0070	MV Monitor (Heating)	---
D0011	D0041	D0071	Nothing assigned.	---
...	...	...	...	...
D0014	D0044	D0074	Nothing assigned.	---

\* If the default settings are used and a sensor is not connected, the PV display on the E5CC will show an input error (5.ERR) and the process value in the upload area will be 1320 (528 hex).

## Changing E5CC Settings

### (1) We will check the area that is used to change E5CC set values.

The area that is used to change the set value is called the download area. D0015 to D0029 is the download area for the No. 0 Controller, D0045 to D0059 is the download area for the No. 1 Controller, and D0075 to D0089 is the download area for the No. 2 Controller.

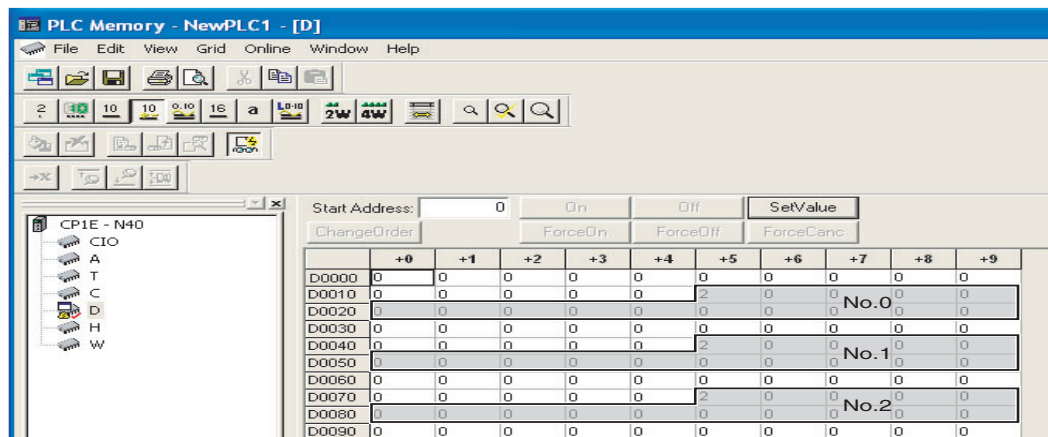

With the default settings, the following parameters are set for the download areas.

No.0	No.1	No.2	Parameter	Value (E5CC default settings)
D0015	D0045	D0075	Request Flag (fixed)	1 (0001 hex)
D0016	D0046	D0076	Operation Command Code (fixed)	0 (0000 hex)
D0017	D0047	D0077	Set Point	0 (0000 hex)
D0018	D0048	D0078	Proportional Band	80 (0050 hex)
D0019	D0049	D0079	Integral Time	233 (00E9 hex)
D0020	D0050	D0080	Derivative Time	40 (0028 hex)
D0021	D0051	D0081	Alarm Value 1	0 (0000 hex)
D0022	D0052	D0082	Alarm Value Upper Limit 1	0 (0000 hex)
D0023	D0053	D0083	Alarm Value Lower Limit 1	0 (0000 hex)
D0024	D0054	D0084	Alarm Value 2	0 (0000 hex)
D0025	D0055	D0085	Alarm Value Upper Limit 2	0 (0000 hex)
D0026	D0056	D0086	Alarm Value Lower Limit 2	0 (0000 hex)
D0027	D0057	D0087	Heater Burnout Detection 1	0 (0000 hex)
D0028	D0058	D0088	Process Value Input Shift	0 (0000 hex)
D0029	D0059	D0089	SP Ramp Set Value	0 (0000 hex)

**(2) We will initialize the download areas with the set values from the E5CC Controllers.**

The download areas have not been initialized, so we will initialize them with the set values from the E5CC Controllers. Double-click **D0015** (Request Flag) in the PLC Memory Window. The following dialog box is displayed. Enter 2 (Initialize Download Areas) and click the **OK** Button.

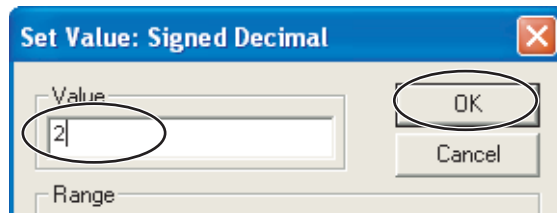

**(3) We will confirm that the download areas have been initialized.**

When initialization is completed, D0000 (Response Flag) will change to 1 (Normal End) and D0015 (Request Flag) will automatically change to 1 (Enable Writing). Check the download area to see if it has been initialized to the values given in the above table. Confirm this for the No. 1 and No. 2 Controllers as well.

**(4) We will change the set point for the No. 0 Controller.**

Double-click **D0017** (Set Point) in the PLC Memory Window, enter 100 (64 hex) for the value, and then click the **OK** Button. Confirm that D0000 (Request Flag) remains at 1 (Enable Writing) and that the SV Display on the No. 0 Controller changes to 100. Confirm this for the No. 1 and No. 2 Controllers as well.

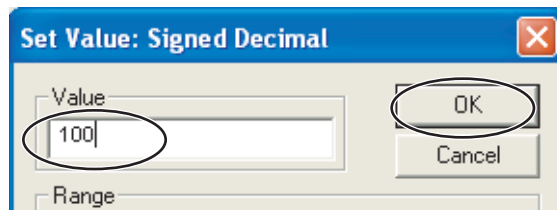

## Stopping the E5CC Controllers

- (1) **We will change the values that are displayed for PLC memory to hexadecimal values.**  
In the PLC Memory Window, select **View – Display – Hexadecimal** from the menu bar.
- (2) **We will stop the No. 0 Controller.**  
Change the RUN/STOP parameter ( $R-5$ ) in the operation level of the E5CC to RUN ( $RUN$ ).  
For a Controller with event inputs, the Event Input 2 Assignment parameter ( $E2-2$ ) in the initial setting level is set to RUN/STOP ( $STOP$ ), so the RUN/STOP parameter will not be displayed. Change the Event Input 2 Assignment parameter to NONE ( $NONE$ ), and then change the RUN/STOP parameter to RUN.
- (3) **We will switch the No. 0 Controller to STOP.**  
Confirm that **D0015** (Request Flag) in the PLC Memory Window is 0001 (Enable Writing), double-click **D0016** (Operation Command Code), enter 0101 hex (STOP), and then click the **OK** Button.  
D0016 will change to 0000, D0000 (Response Flag) will remain at 0001 (Enable Writing), and “STOP” will be displayed on the No. 0 Controller.  
Confirm this for the No. 1 and No. 2 Controllers as well.  
For details on other operation command codes, refer to *6-3-4 Operation Command Codes*.

## 6-5 Connecting to CJ-series PLCs

### 6-5-1 Configuration and Procedure

The following configuration is used as an example in giving the setup and application procedures for programless communications.

- All of the E5CC Controllers must be the same model. (Copying parameter settings is not possible if the models are different.)
- D0000 to D0089 are used in the PLC memory. The default E5CC parameter allocations are used.
- A commercially available USB2.0, A/B cable is used.

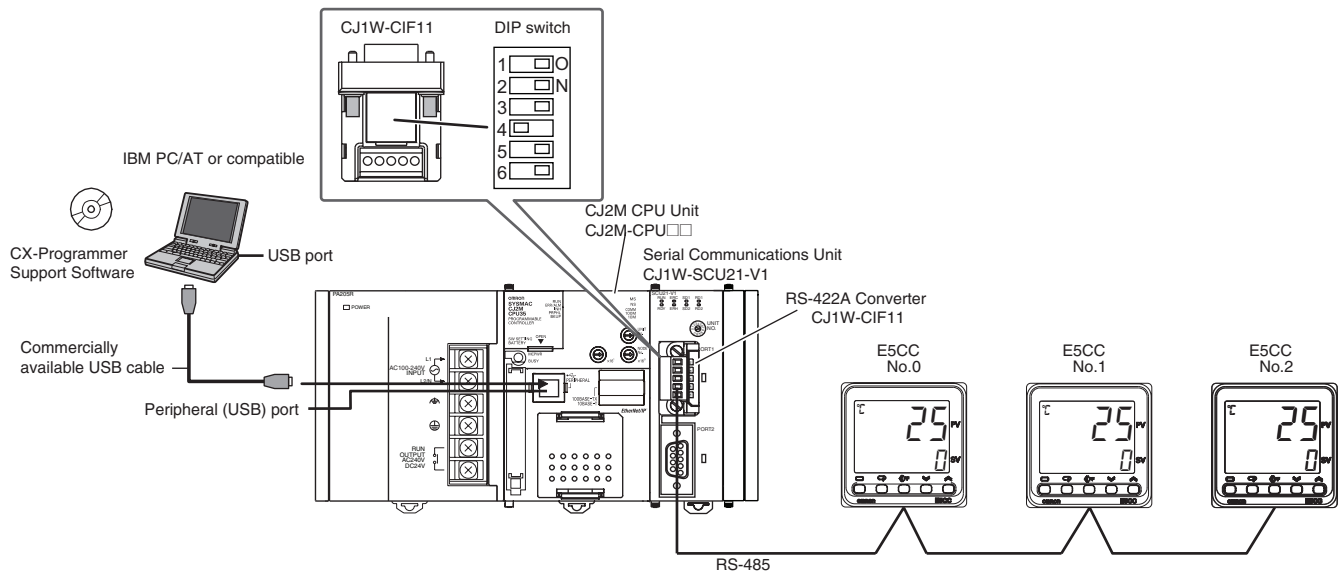

Note: Refer to the *CX-Programmer Operation Manual* (Cat. No. W446) for information on installing the CX-Programmer and USB driver.

The application procedure is given below.

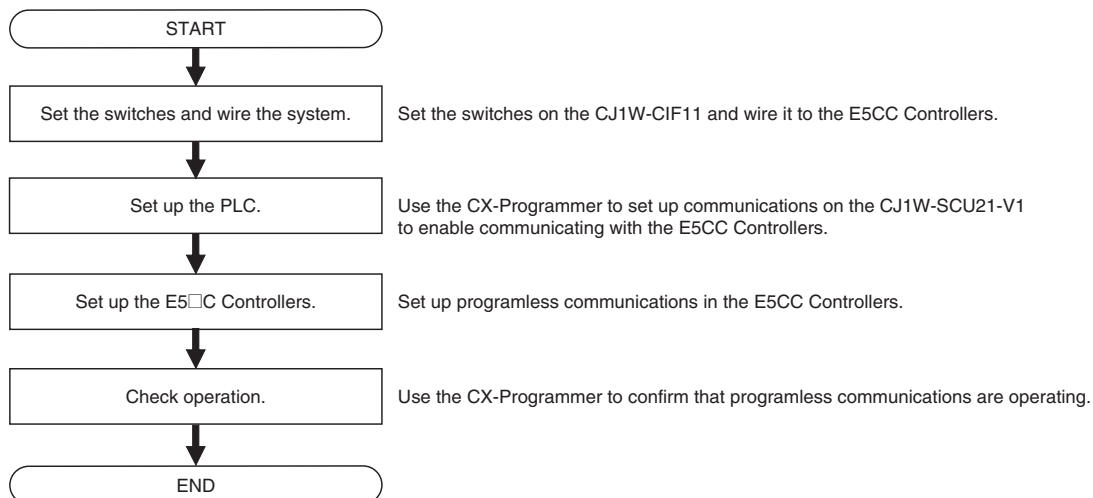

## 6-5-2 Switch Settings and Wiring

Before you attach the CJ1W-CIF11 to the CJ1W-SCU21-V1, turn OFF pin 4 on the DIP switch on the back of the CJ1W-CIF11 and turn ON the rest of the pins.

Pin	OFF	ON	Setting
1	No terminating resistance	Terminating resistance on both ends	Terminating resistance selection
2	4-wire	2-wire	2-wire or 4-wire selection
3	4-wire	2-wire	Same as above.
4	---	---	Not used.
5	RS control disabled. (Signal always received.)	RS control enabled.	RS control selection for RD
6	RS control disabled. (Signal always sent.)	RS control enabled.	RS control selection for SD

Wire the CJ1W-CIF11 to the E5CC Controllers as shown below.

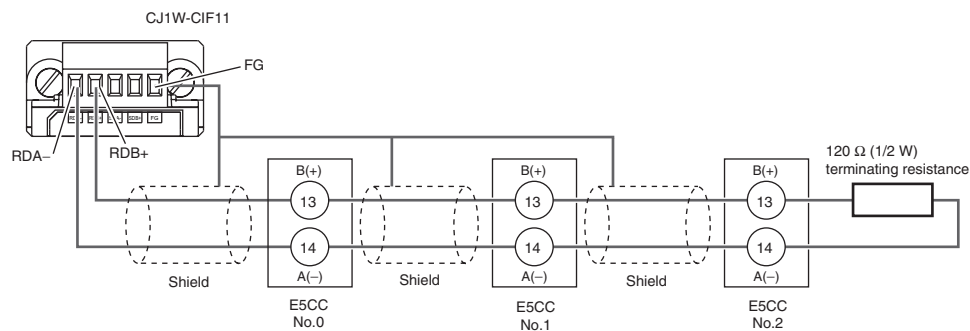

Note: 1 The maximum transmission distance is 50 m.

2 For wiring methods, refer to *Appendix G CJ1W-CIF11 RS-422A Converter* in the *SYSMAC CJ/NSJ Series Operation Manual* (Cat. No. W393).

## 6-5-3 PLC Setup

Set up communications on the CJ1W-SCU21-V1 to enable communicating with the E5CC Controllers. PLC operation will stop and the power supply will be cycled during the setup procedure. Make sure that this will not create any problems in the controlled system.

### Connecting to the PLC

Refer to *Connecting to the PLC* in *6-4-3 PLC Setup*.

## Communications Settings in the Serial Communications Unit (SCU)

- (1) The PLC operating mode must be changed to PROGRAM mode to enable changing the SCU communications settings.

Select **PLC – Operating Mode – Program** from the menu bar. A confirmation dialog box will be displayed. Click the **Yes** Button.

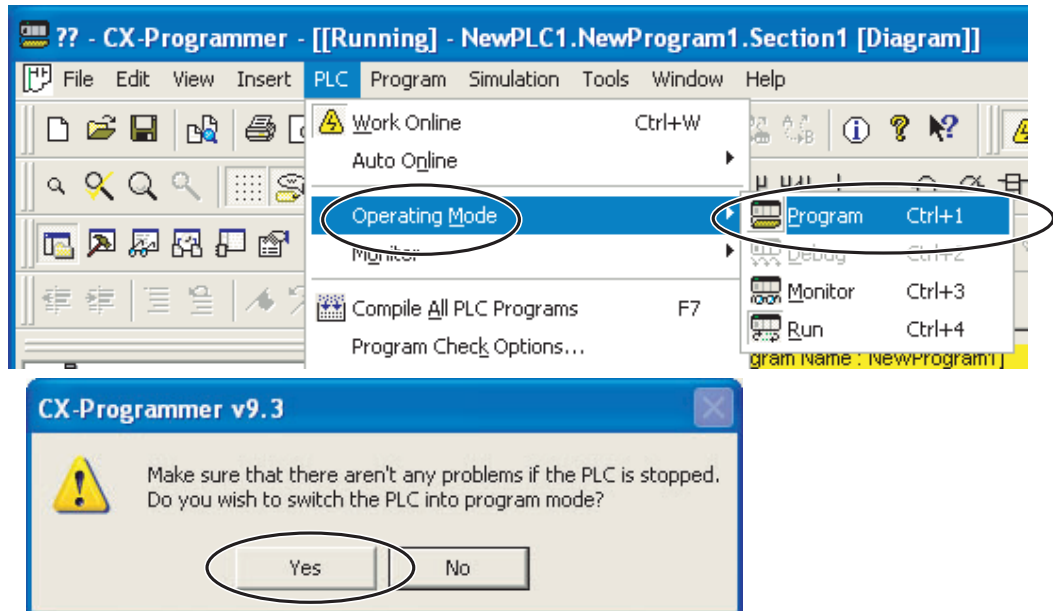

- (2) Double-click IO Table and Unit Setup. The IO Table Window will be displayed.

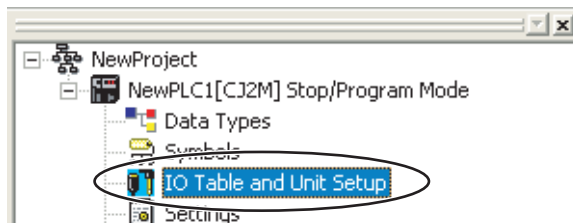

- (3) Double-click CJ1W-SCU21-V1. The CJ1W-SCU21-V1 Setting Window will be displayed.

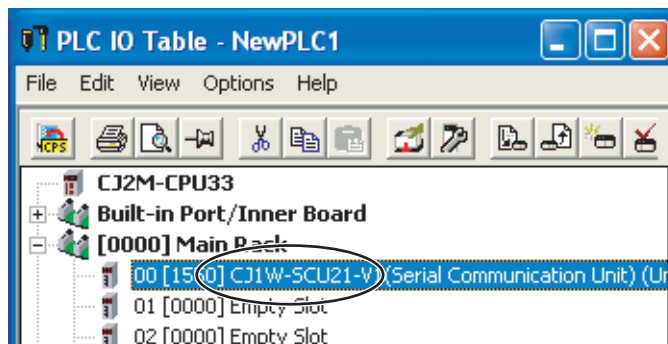

**(4) We will change the communications settings for port 1.**

Set *Port 1: Port settings* to *User settings*, set *Port 1: Baud rate* to *57600 bps*, and then click the **Transfer [PC to Unit]** Button. Use the defaults settings for the other parameters.

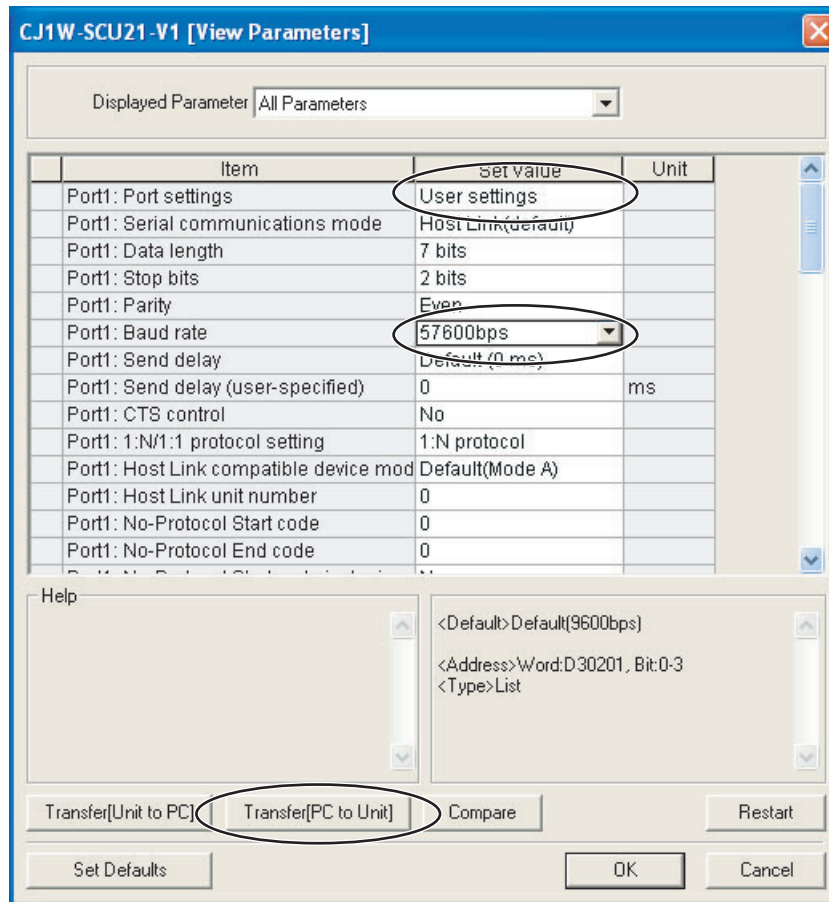

Note: If you change the unit number, refer to *6-2-7 Communications Node Number*.

Click the **Yes** Button. The settings will be transferred. After the data has been transferred, click the **OK** Button.

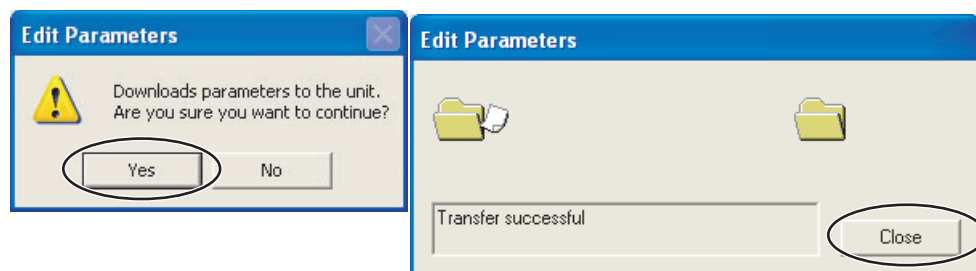

Click the **Yes** Button to restart the Unit. Select **All ports** and then click the **OK** Button. A dialog box will be displayed when the Unit has been restarted. Click the **OK** Button. This completes the PLC setup procedure. You will use the CX-Programmer to check operation, so leave it online.

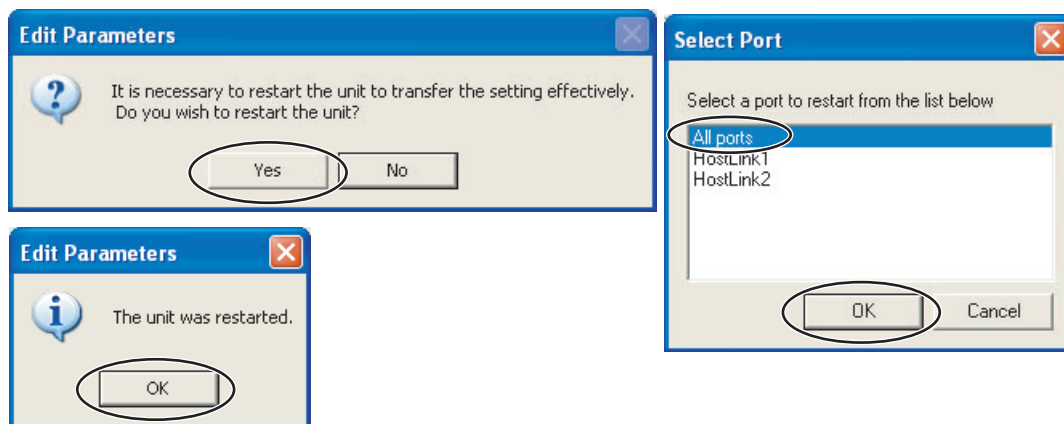

#### 6-5-4 E5□C Controller Setup

Set up programless communications. Perform the procedure that is given in *6-4-4 E5@C Controller Setup*.

#### 6-5-5 Checking Operation

Perform the procedure that is given in *6-4-5 Checking Operation*.



## 6-6 Connecting to MELSEC Q-series PLCs

### 6-6-1 Configuration and Procedure

The following configuration is used as an example in giving the setup and application procedures for programless communications.

- All of the E5CC Controllers must be the same model. (Copying parameter settings is not possible if the models are different.)
- D0 to D89 are used in the PLC memory. The default E5CC parameter allocations are used.
- A commercially available USB2.0, A/B cable is used.

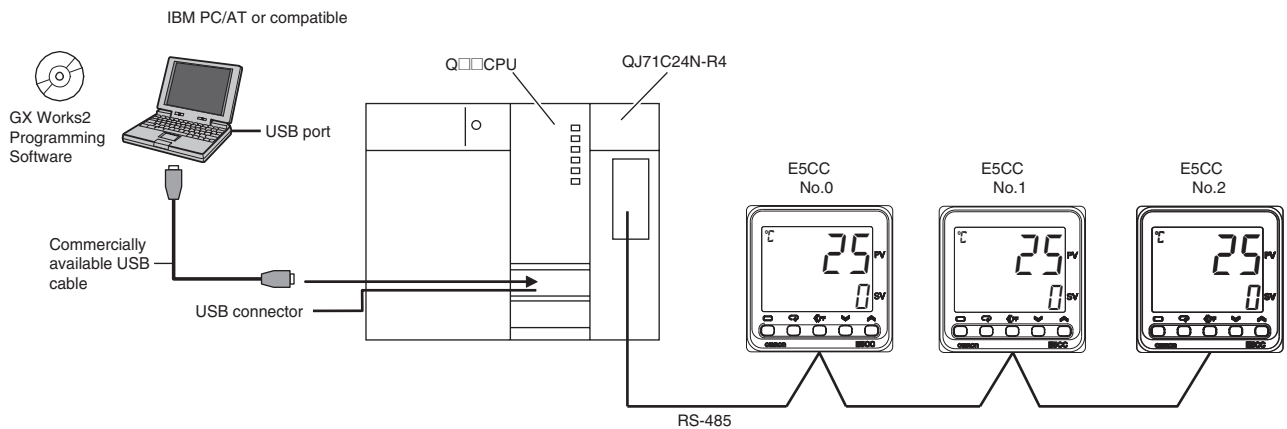

Note: Refer to the *GX Works2 Installation Instructions (BCN-P5713)* for information on installing the GX Works2 and to the *GX Works2 Version 1 Operating Manual (Common) (SH-080779ENG)* for information on installing the USB driver.

The application procedure is given below.

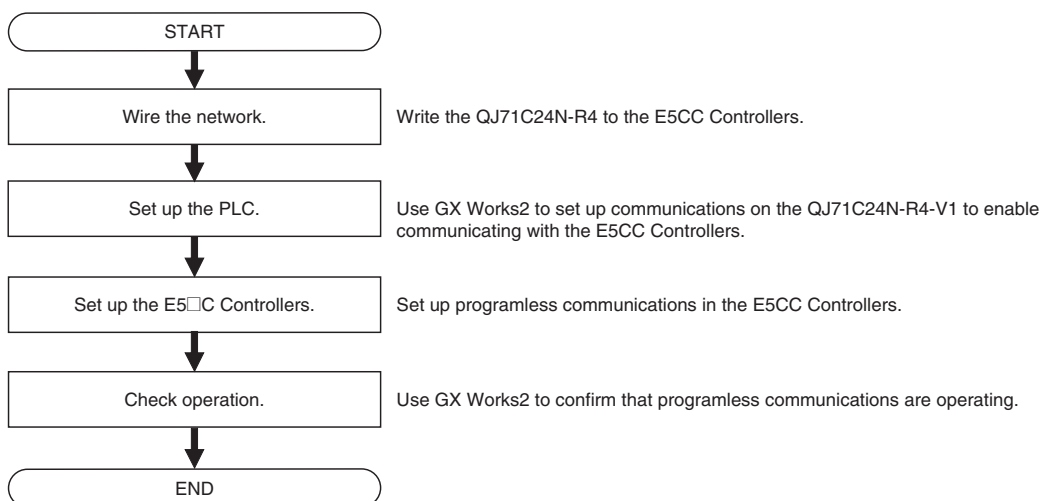

## 6-6-2 Wiring

Wire the QJ71C24N-R4 to the E5CC Controllers as shown below.

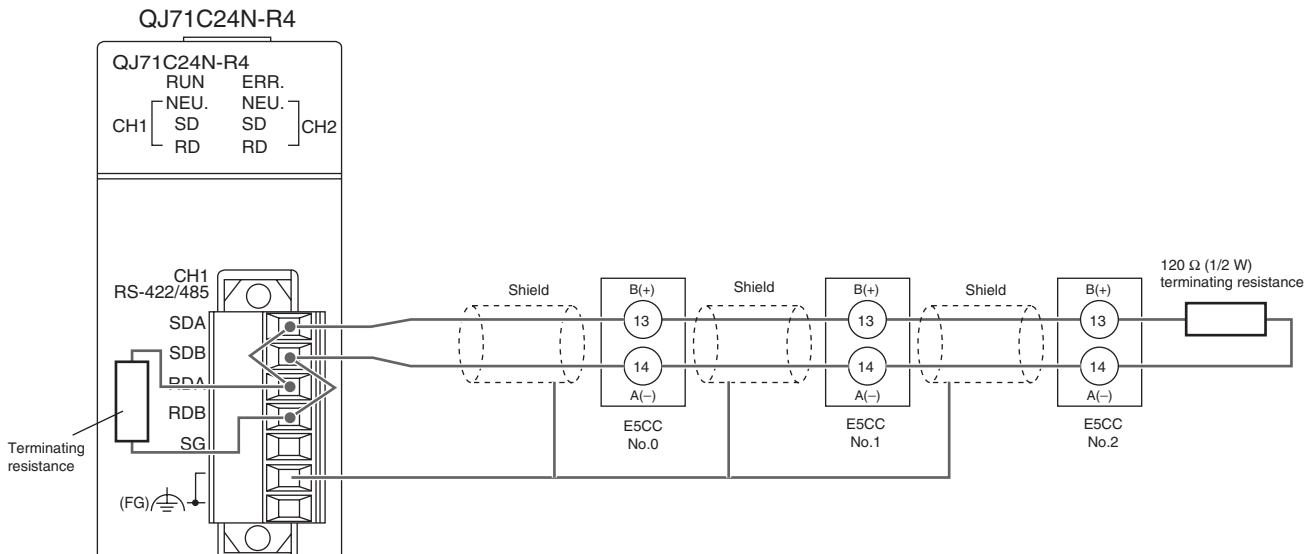

- Note:
- 1 Use a terminating resistance of at least 54  $\Omega$ .
  - 2 The maximum transmission distance is 500 m.
  - 3 For wiring methods, refer to 3.3 *RS-422/485 Interface Specifications* and 4.4.2 *Connecting the RS-422/485 Interface* in the *Q Corresponding Serial Communication Module Users Manual (Basic)* (SH-080006).

## 6-6-3 PLC Setup

Set up communications on the QJ71C24N-R4 to enable communicating with the E5CC Controllers. PLC operation will stop and the power supply will be cycled during the setup procedure. Make sure that this will not create any problems in the controlled system.

### Connecting to the PLC

- (1) Connect the computer to the Q-series CPU Module and then start GX Works2.
- (2) Select **Online – Read from PLC** from the menu bar.

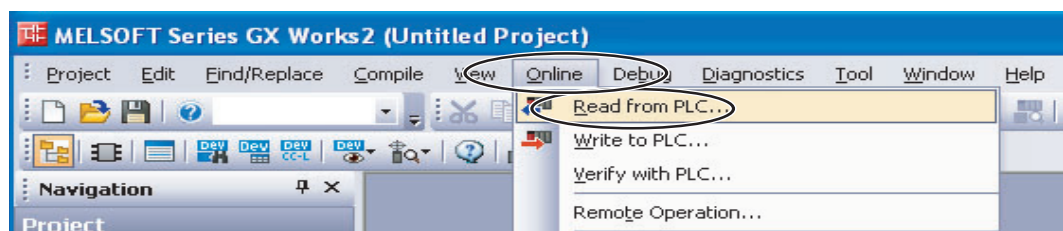

- (3) Select **QCPU (Q mode)**, and then click the **OK** Button.

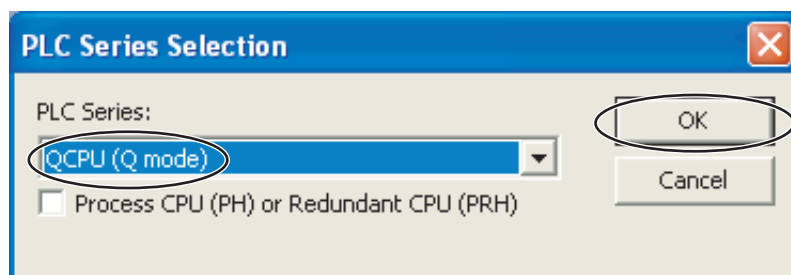

(4) Click the OK Button.

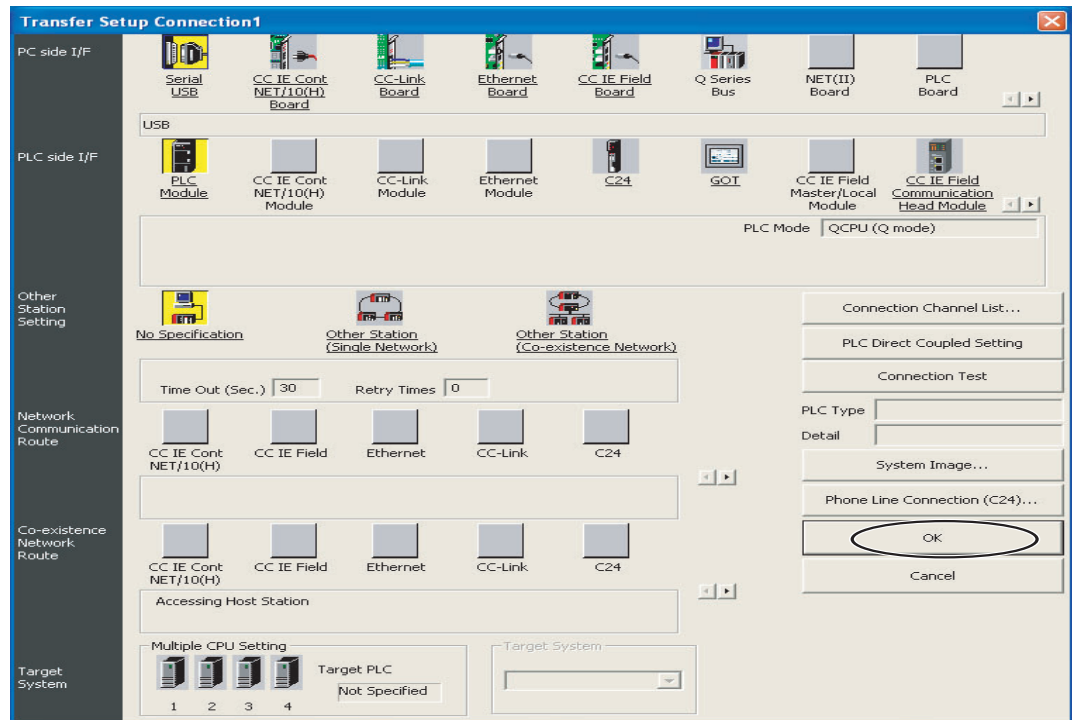

(5) Click the Execute Button.

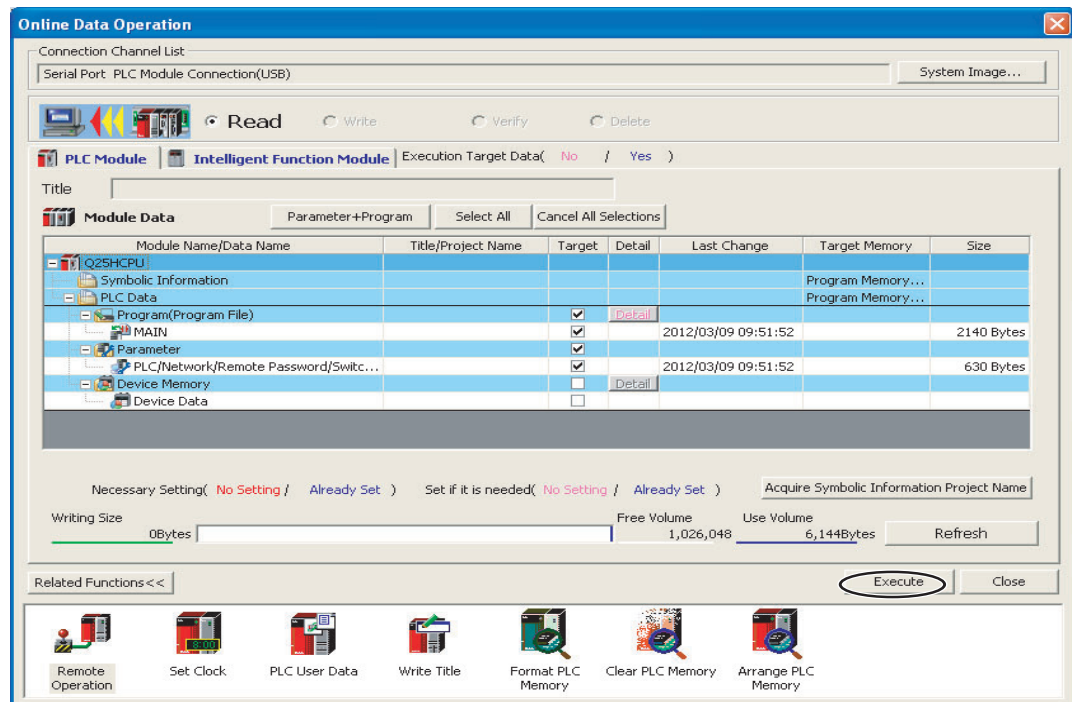

- (6) When the set values have been read, click the Close Button. Also close the above dialog box.

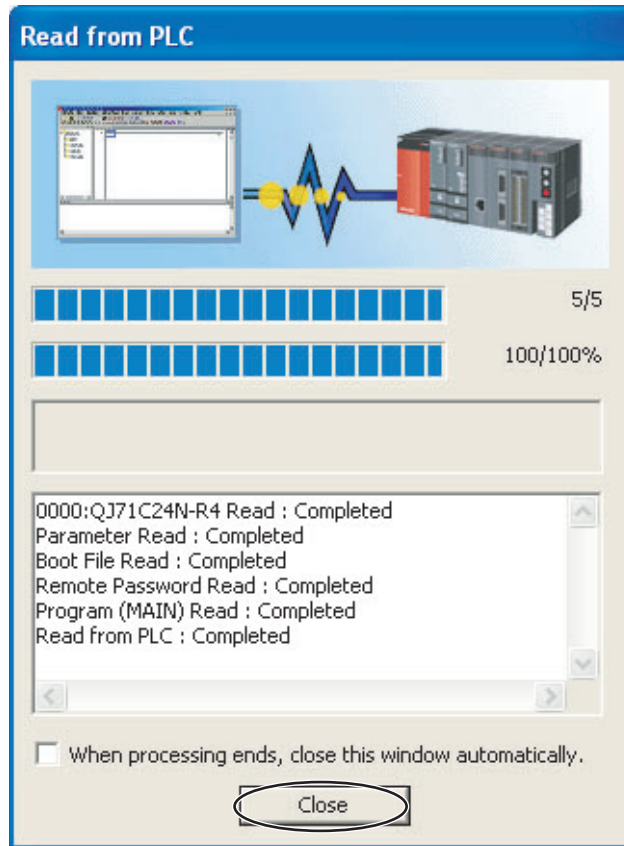

## Communications Settings in the Serial Communication Module

- (1) Double-click Switch Setting. The Switch Setting Dialog Box for communications will be displayed.

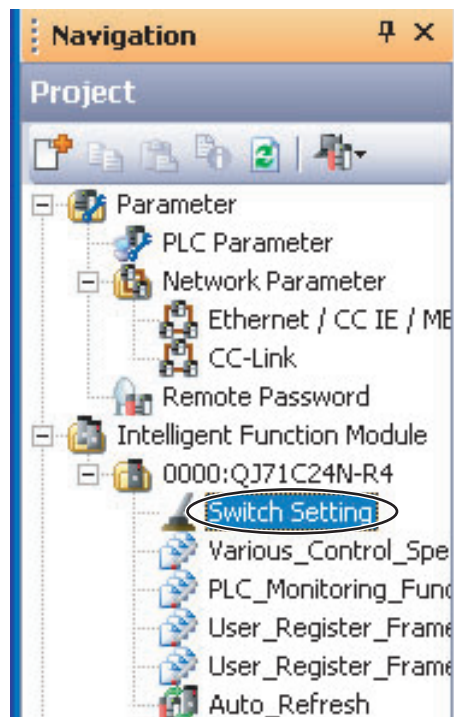

**(2) We will change the communications settings for CH1.**

Change the following settings, and then click the **OK** Button. Use the defaults settings for the other parameters.

- Parity Bit: Exist
- Even/odd parity: Even
- Stop bit: 2
- Sum check code: Exist
- Online Change: Enable
- Setting modifications: Enable
- Communication rate setting: 57600 bps (This setting can be changed after you change the communication protocol setting.)
- Communication protocol setting: MC protocol (Format 4)

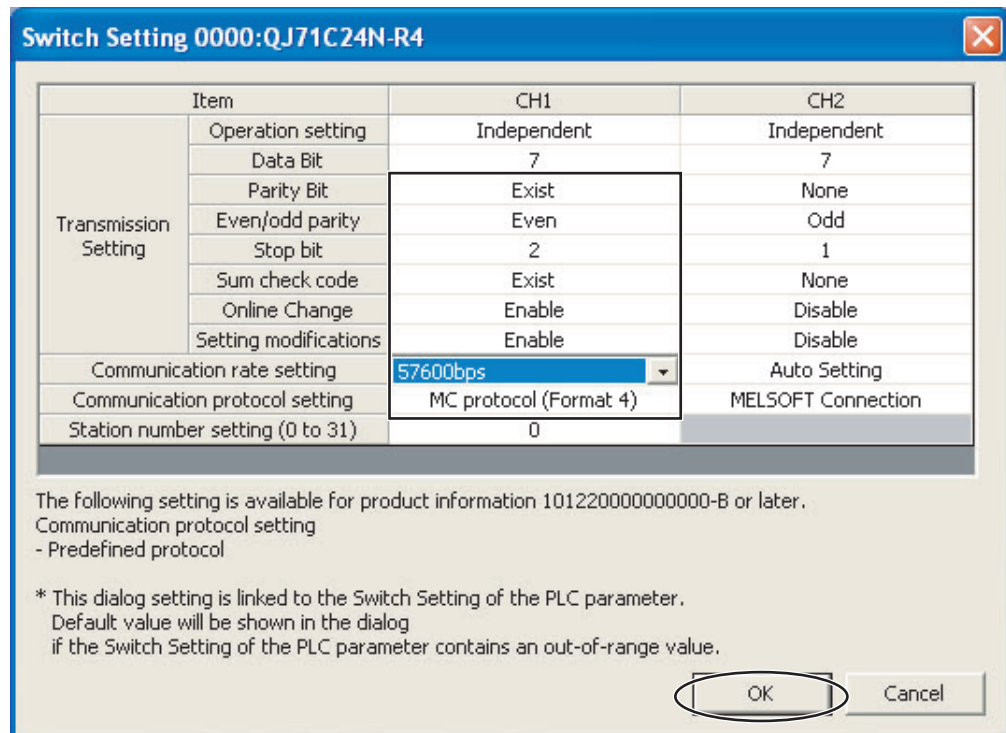

Note: If you change the station number setting, refer to *6-2-7 Communications Node Number*

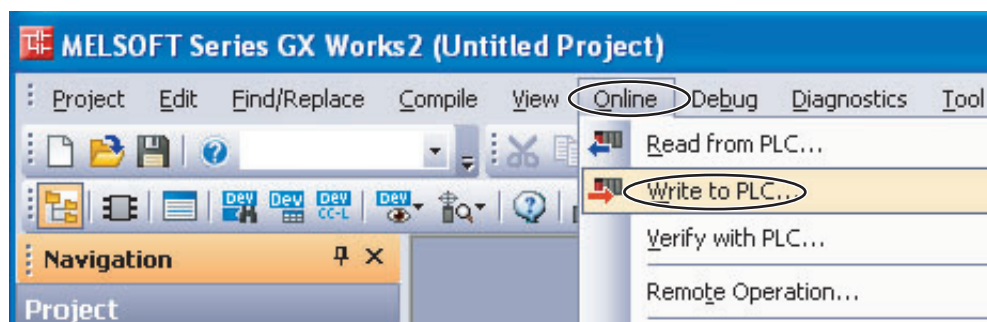
**(3) Select *Online - Write to PLC*. A dialog box to write the set values will be displayed.**

(4) We will write set values to the PLC.

Click the **Intelligent Function Module** Tab and select the check box for the Serial Communication Module in the *Valid* Column. Then click the **PLC Module** Tab, select the check box for the parameters in the Target Column, and then click the **Execute** Button.

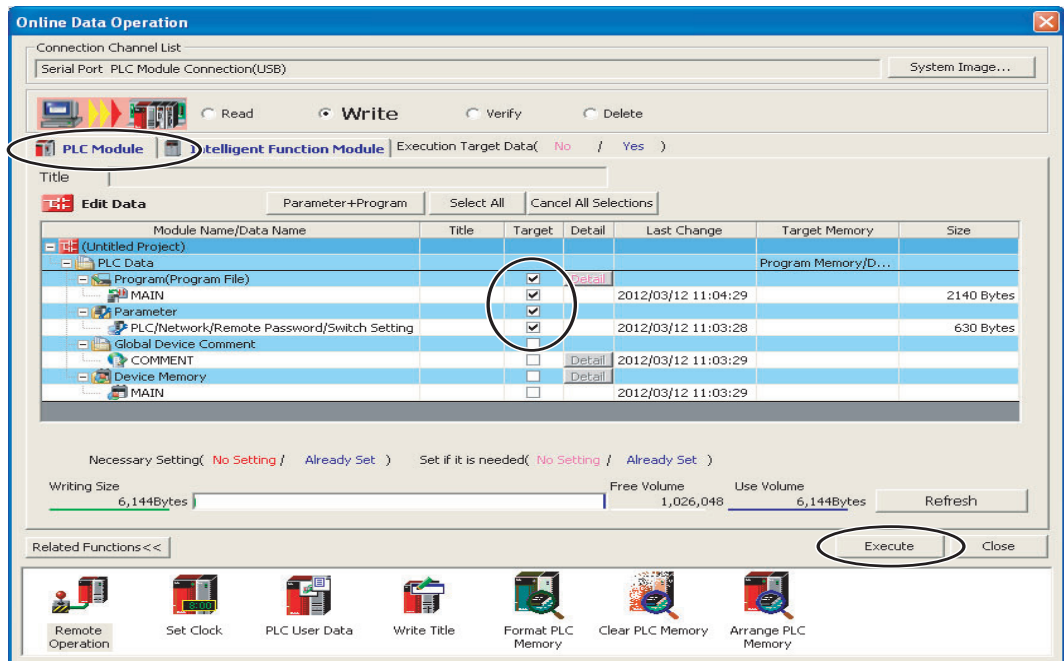
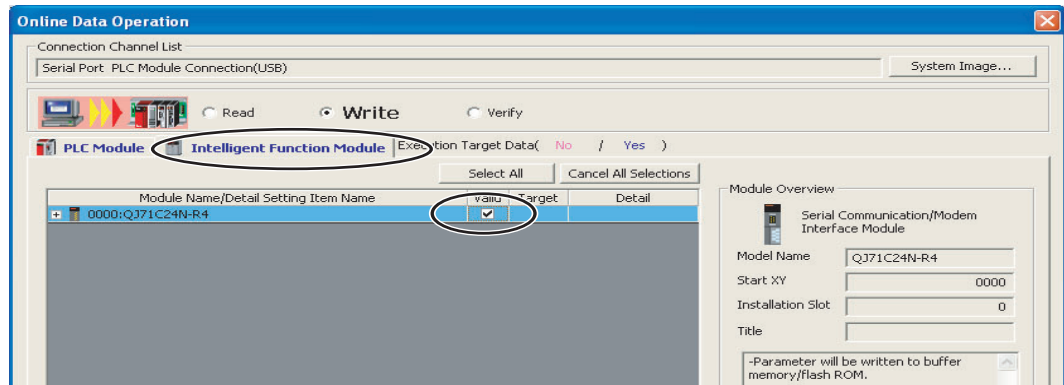

**(5) We will write set values to the PLC.**

Some dialog boxes will be displayed before and after the following dialog box. Click the **Yes** Button for of them, or click the **Yes to All** Button.

When the following dialog box is displayed, click the **Close** Button. Also close the dialog box to write set values, and then cycle the power supply to the PLC.

This completes the PLC setup procedure. You will use GX Works2 to check operation, so leave it online.

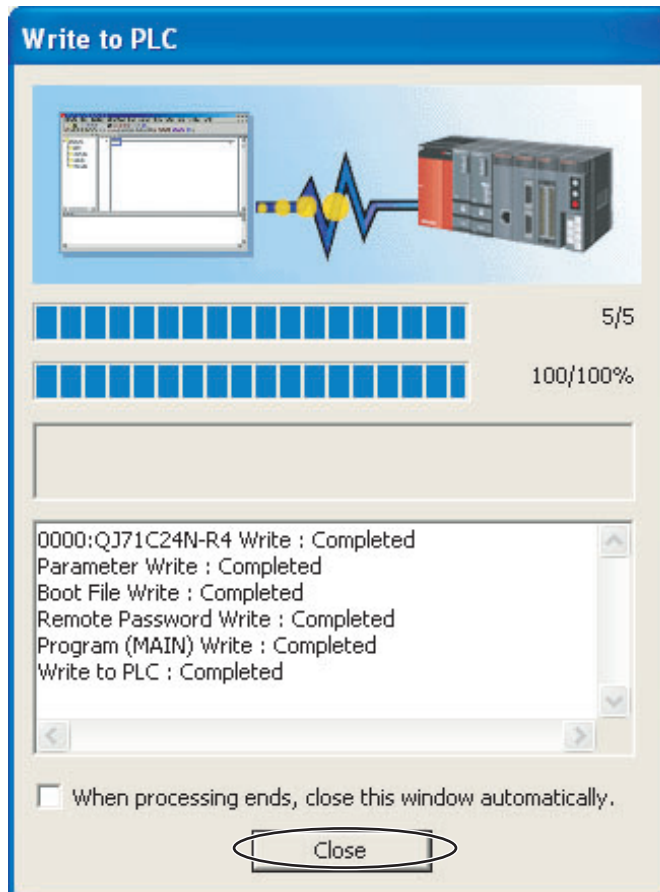
**6-6-4 E5□C Controller Setup**

Set up programless communications. Perform the procedure that is given in 6-4-4 *E5@C Controller Setup*.

### 6-6-5 Checking Operation

The SP and RUN/STOP status of the E5□C Controllers will be changed to check operation. Make sure that this will not create any problems in the controlled system.

#### ● Checking E5CC Monitor Values

##### (1) We will display PLC memory in a dialog box.

Select **Online – Monitor – Device/Buffer Memory Batch Monitor**.

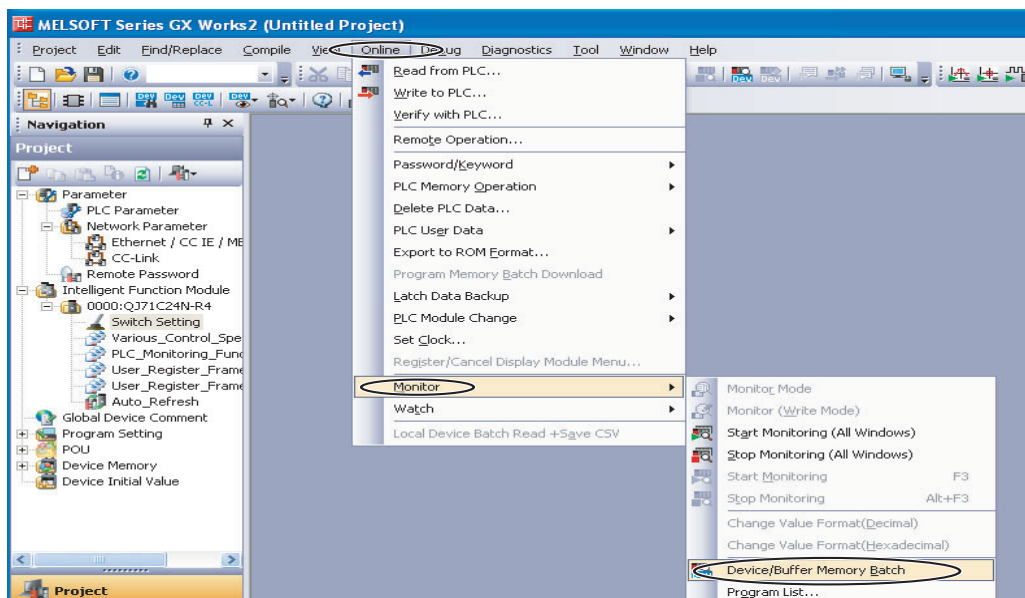

##### (2) We will monitor PLC memory in a dialog box.

Enter **D0** for in the *Device Name* Box and press the **Enter** Key on the computer's keyboard. Monitoring of D0 will be started.

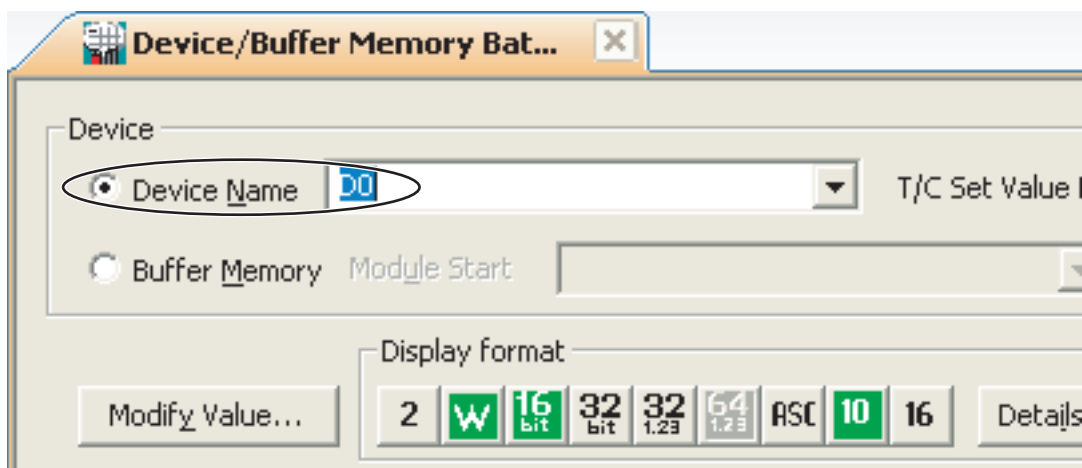



- (3) To make the value easier to check, we will change the values that are displayed to decimal values.

Click the **Display Format** Button in the above dialog box, select the *Word Multi-point* Option in the Monitor Format Area, select the *10 Points* Option in the Word Device Word Multi-point Format Area, and then click the **OK** Button.

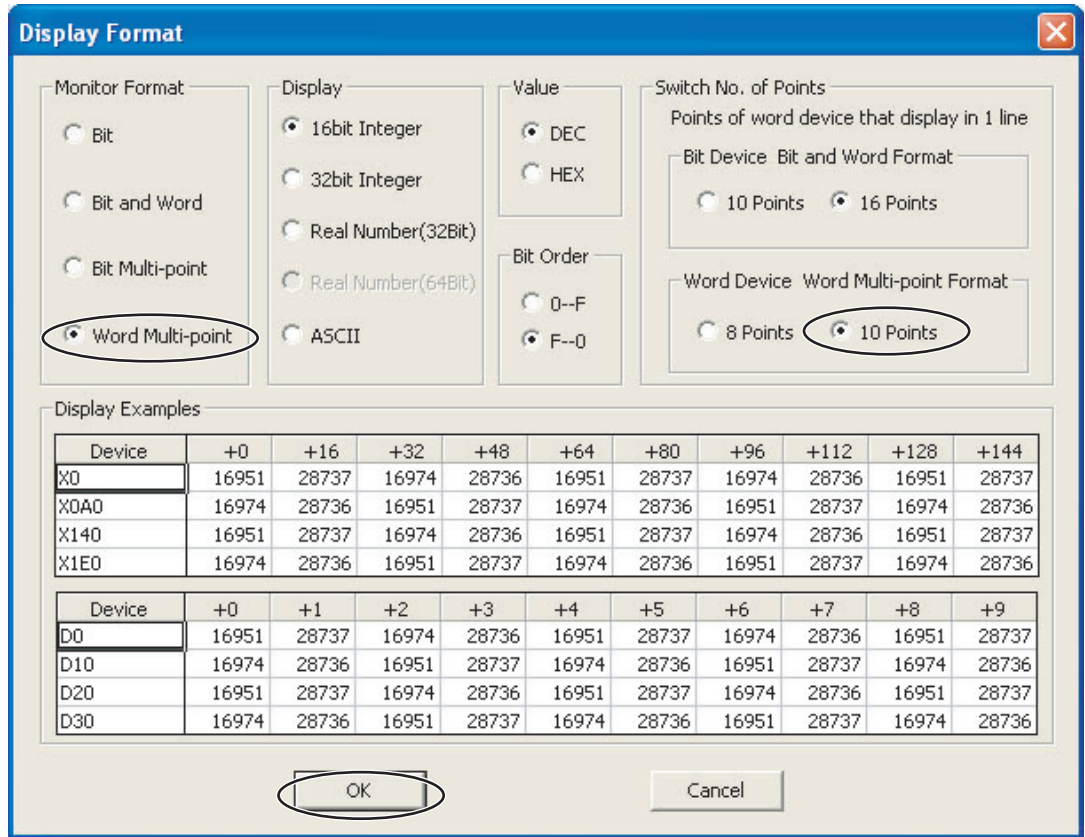

- (4) We will check the E5CC monitor values.

The area where monitor values are checked is called the upload area.

D0 to D14 is the upload area for the No. 0 Controller, D30 to D44 is the upload area for the No. 1 Controller, and D60 to D74 is the upload area for the No. 2 Controller.

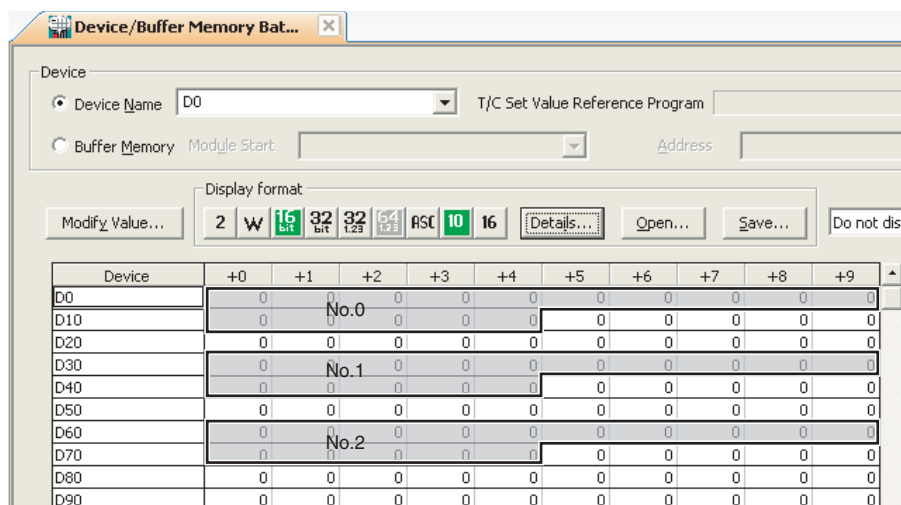

With the default settings, the following parameters are set for the upload areas. Check the values in the upload areas to see if they are the same as those that are given in the following table. (It is not necessary to check address for which “---” is given in the Value column.)

No.0	No.1	No.2	Parameter	Value
D0	D30	D60	Response Flag (fixed)	0
D01	D31	D61	Communications Status (fixed)	Alternates between 0 and 1.
D02	D32	D62	Communications Monitor Parameter	---
D03	D33	D63	Status (Upper Word)	---
D04	D34	D64	Status (Lower Word)	---
D05	D35	D65	Status 2 (Upper Word)	---
D06	D36	D66	Decimal Point Monitor	---
D07	D37	D67	Process Value	Process Value *1
D08	D38	D68	Internal Set Point	---
D09	D39	D69	Heater Current 1 Value Monitor	---
D10	D40	D70	MV Monitor (Heating)	---
D11	D41	D71	Not used.	---
...	...	...	...	...
D14	D44	D74	Not used.*2	---

\*1 If the default settings are used and a sensor is not connected, the PV display on the E5CC will show an input error (S.ERR) and the process value in the upload area will be 1320 (528 hex).

\*2 This area cannot be used for a Mitsubishi FX-series PLC.

### ● Changing E5CC Settings

(1) We will check the area that is used to change E5CC set values.

The area that is used to change the set value is called the download area. D15 to D29 is the download area for the No. 0 Controller, D45 to D59 is the download area for the No. 1 Controller, and D75 to D89 is the download area for the No. 2 Controller.

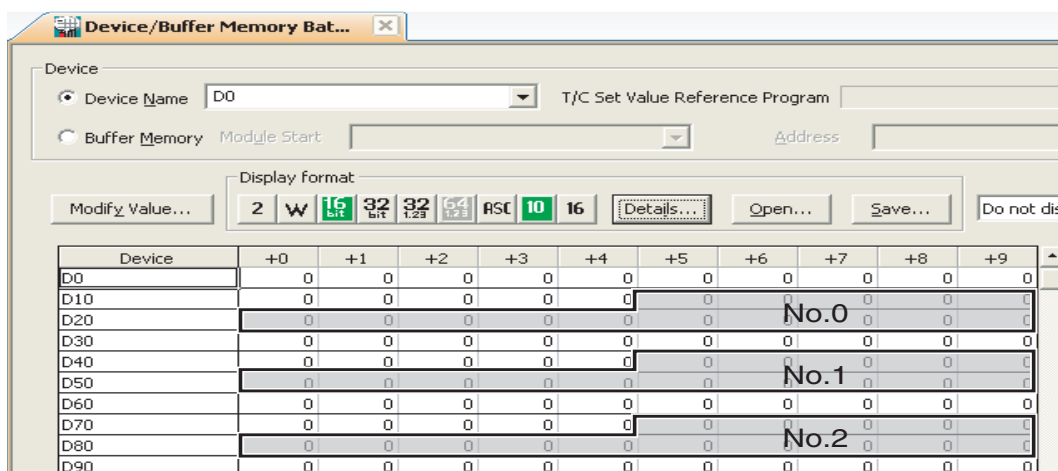

With the default settings, the following parameters are set for the download areas.

No.0	No.1	No.2	Parameter	Value (E5CC default settings)
D15	D45	D75	Request Flag (fixed)	1 (0001 hex)
D16	D46	D76	Operation Command Code (fixed)	0 (0000 hex)
D17	D47	D77	Set Point	0 (0000 hex)
D18	D48	D78	Proportional Band	80 (0050 hex)
D19	D49	D79	Integral Time	233 (00E9 hex)
D20	D50	D80	Derivative Time	40 (0028 hex)
D21	D51	D81	Alarm Value 1	0 (0000 hex)
D22	D52	D82	Alarm Value Upper Limit 1	0 (0000 hex)
D23	D53	D83	Alarm Value Lower Limit 1	0 (0000 hex)
D24	D54	D84	Alarm Value 2	0 (0000 hex)
D25	D55	D85	Alarm Value Upper Limit 2	0 (0000 hex)
D26	D56	D86	Alarm Value Lower Limit 2	0 (0000 hex)
D27	D57	D87	Heater Burnout Detection 1	0 (0000 hex)
D28	D58	D88	Process Value Input Shift	0 (0000 hex)
D29	D59	D89	SP Ramp Set Value	0 (0000 hex)

**(2) We will initialize the download areas with the set values from the E5CC Controllers.**

The download areas have not been initialized, so we will initialize them with the set values from the E5CC Controllers.

Double-click **D15** (Request Flag) on the Device Memory Dialog Box. The following dialog box is displayed. Enter 2 (Initialize Download Areas), click the **Set** Button, and then click the **Close** Button.

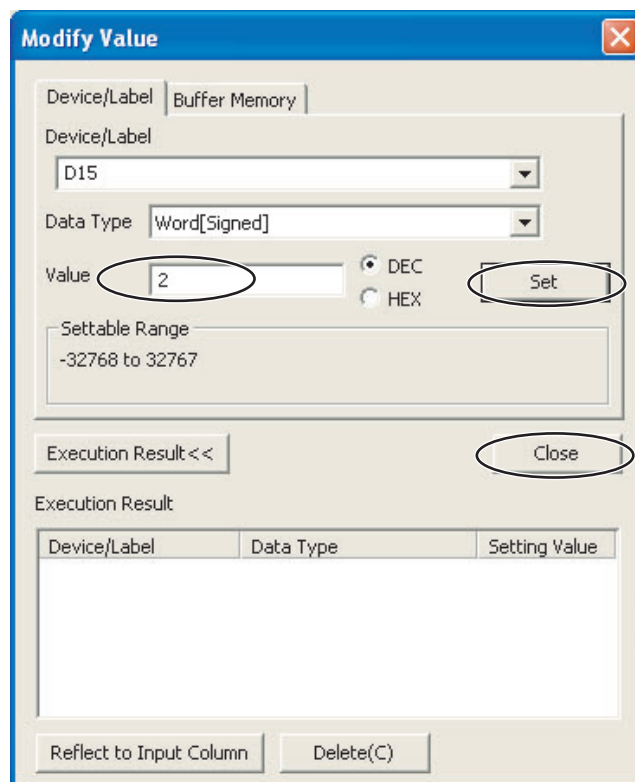

**(3) We will confirm that the download areas have been initialized.**

When initialization is completed, D0 (Response Flag) will change to 1 (Normal End) and D15 (Request Flag) will automatically change to 1 (Enable Writing). Check the download area to see if it has been initialized to the values given in the above table.

Confirm this for the No. 1 and No. 2 Controllers as well.

**(4) We will change the set point for the No. 0 Controller.**

Double-click **D17** (Set Point) in the Device Memory Dialog Box, enter 100 (64 hex) for the value, click the **Set** Button, and then click the **Close** Button. Confirm that D0 (Request Flag) remains at 1 (Enable Writing) and that the SV Display on the No. 0 Controller changes to 100.

Confirm this for the No. 1 and No. 2 Controllers as well.

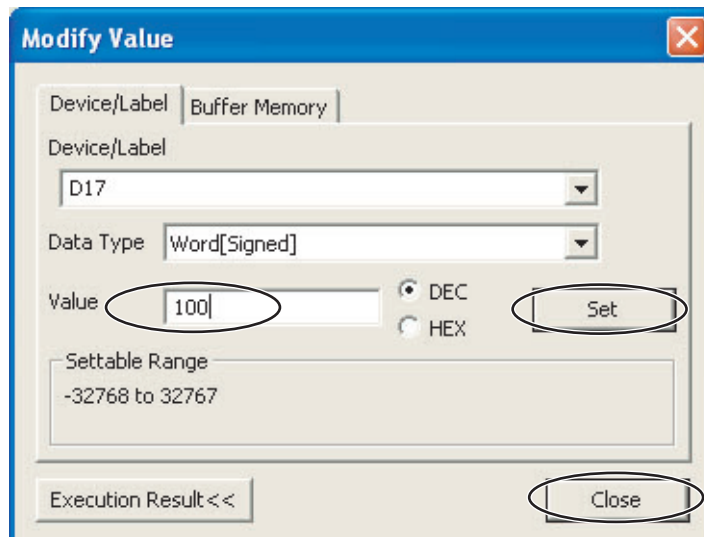

## Stopping the E5CC Controllers

**(1) We will run the No. 0 Controller.**

Change the RUN/STOP parameter ( $R-5$ ) in the operation level of the E5CC to RUN ( $RUN$ ). For a Controller with event inputs, the Event Input 2 Assignment parameter ( $EV-2$ ) in the initial setting level is set to RUN/STOP ( $STOP$ ), so the RUN/STOP parameter will not be displayed. Change the Event Input 2 Assignment parameter to NONE ( $NONE$ ), and then change the RUN/STOP parameter to RUN.

**(2) We will switch the No. 0 Controller to STOP.**

In the Device Memory Dialog Box, make sure that D15 (Request Flag) is 1 (Enable Writing) and then double-click **D16** (Operation Command Code). Select the HEX Option, enter 0101 hex (STOP), click the **Set** Button, and then click the **Close** Button. D16 will change to 0, D0 (Response Flag) will remain at 1 (Enable Writing), and "STOP" will be displayed on the No. 0 Controller. Confirm this for the No. 1 and No. 2 Controllers as well. For details on other operation command codes, refer to 6-3-4 *Operation Command Codes*.

## 6-7 Connecting to MELSEC-FX-series PLCs

This function is supported only for E5□C version 2.1 or later.

### 6-7-1 Configuration and Procedure

The following configuration is used as an example in giving the setup and application procedures for programless communications.

- All of the E5CC Controllers must be the same model. (Copying parameter settings is not possible if the models are different.)
- D0 to D89 are used in the PLC memory. The default E5CC parameter allocations are used.
- A USB A/mini-B cable is used.

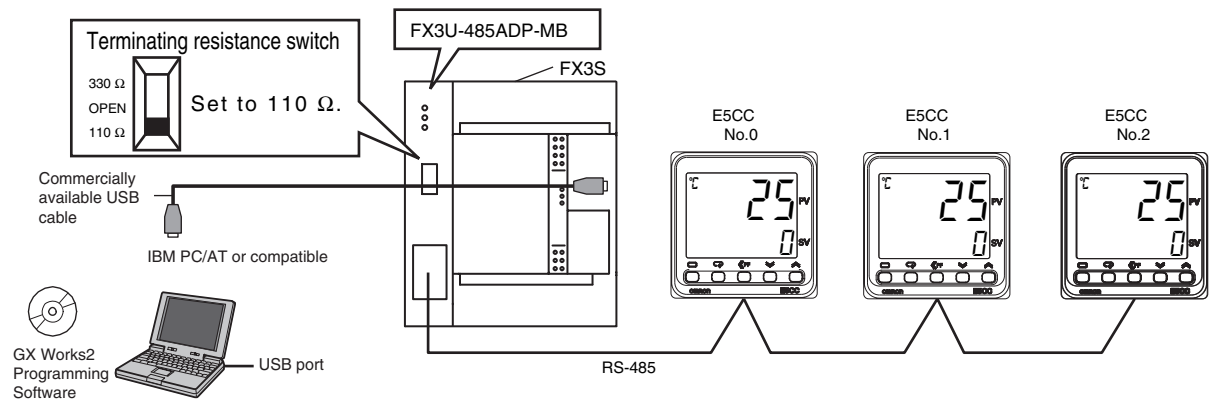

**Note:** Refer to the *GX Works2 Installation Instructions (BCN-P5713)* for information on installing the GX Works2 and to the *GX Works2 Version 1 Operating Manual (Common) (SH-080779ENG)* for information on installing the USB driver.

The application procedure is given below.

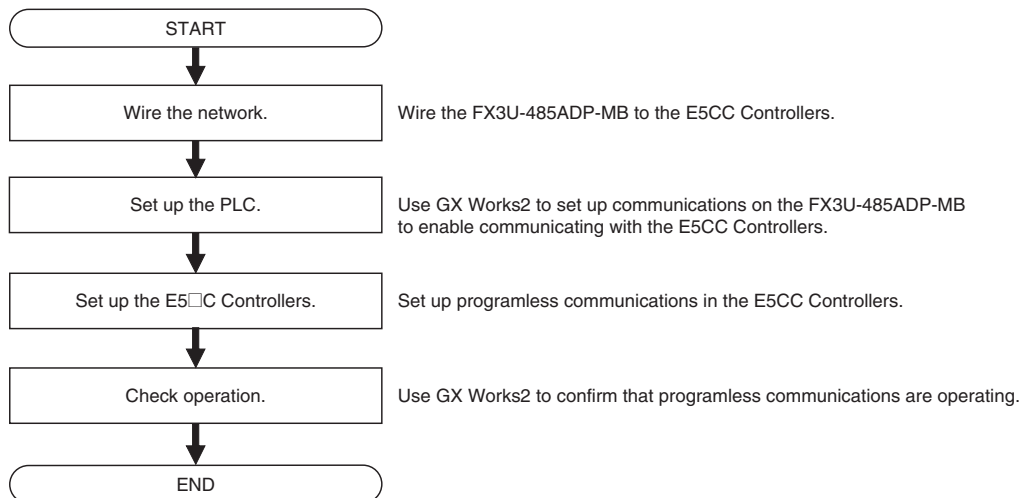

### 6-7-2 Wiring

Set the terminating resistance switch on the front panel of the FX3U-485ADP-MB to 110 Ω.



Wire the FX3U-485ADP-MB to the E5CC Controllers as shown below.

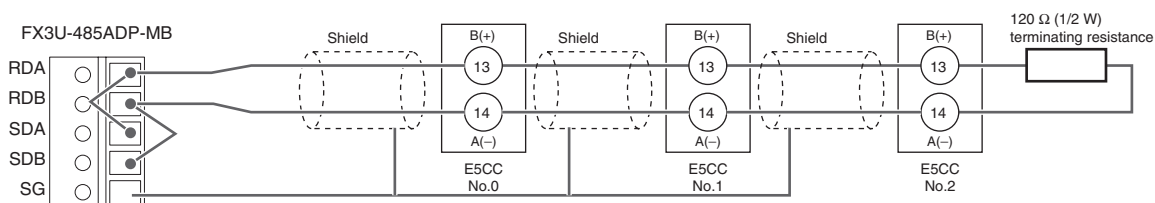

- Note:
- 1 Use a terminating resistance of at least 54 Ω.
  - 2 The maximum transmission distance is 500 m.
  - 3 For wiring methods, refer to 4.5.1 One-pair wiring under D.Computer Link in the FX Series User's Manual, Data Communication Edition (JY997D16901).

### 6-7-3 PLC Setup

Set up communications on the FX3U-485ADP-MB to enable communicating with the E5CC Controllers. PLC operation will stop and the power supply will be cycled during the setup procedure. Make sure that this will not create any problems in the controlled system.

#### Connecting to the PLC

- (1) Connect the computer to the FX-series CPU Module with a USB cable and then start GX Works2.
- (2) Select *Online – Read from PLC* from the menu bar.

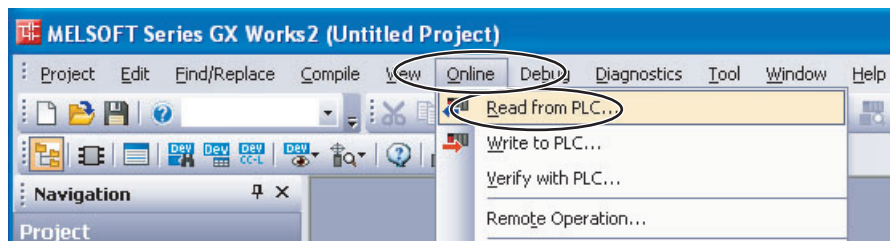

- (3) Select *FXCPU*, and then click the OK Button.

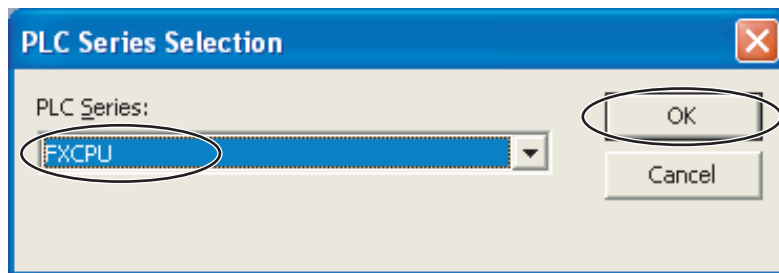

(4) Double-click the **Serial USB** Icon, select the **USB** Option, and click the **OK** Button.

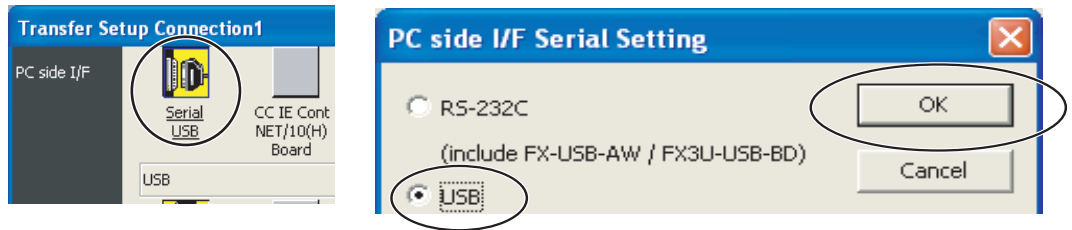

(5) Click the **OK** Button.

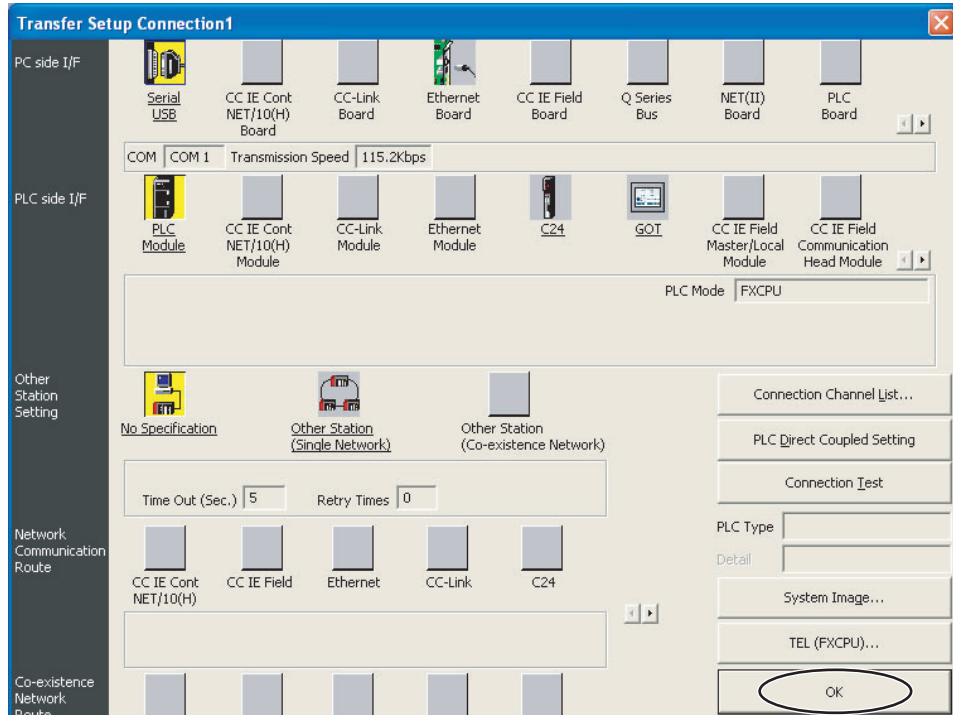

(6) Click the Parameter + Program Button and then click the Execute Button.

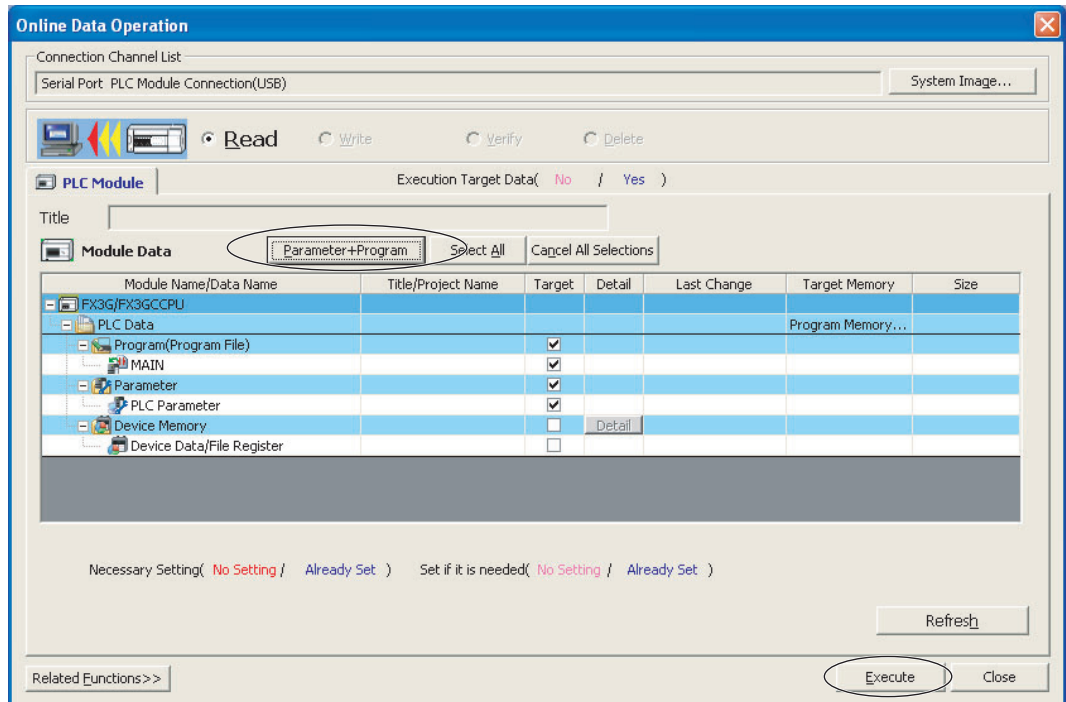

(7) When the set values have been read, click the Close Button. Also close the above dialog box.

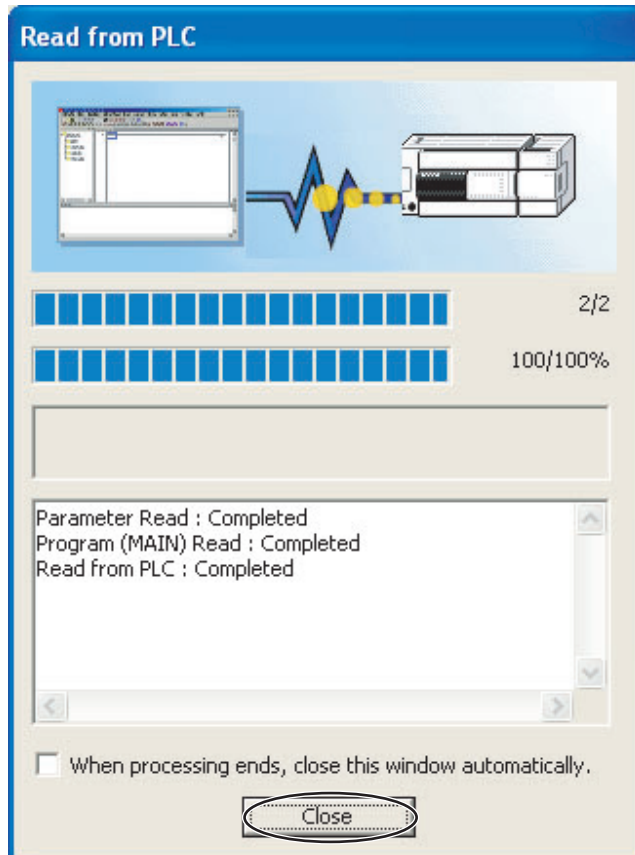



## Setting Up Communications for the Special Communication Adapter

- (1) Double-click *PC Parameter*. The FX Parameter Setting Dialog Box will be displayed.

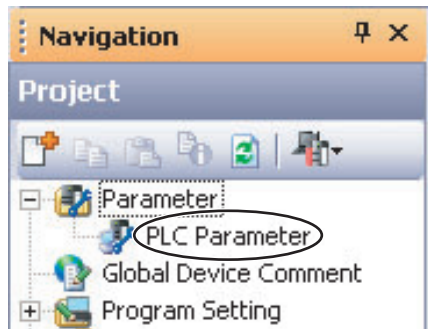

- (2) We will change the communications settings for CH1.

Click the **PC System Setup (2)** Tab, change the following settings, and click the **Finish Setup** Button. Use the defaults settings for the other parameters.

- Operate Communication Setting: Selected.
- Protocol: Dedicated Protocol
- Parity: Even
- Stop Bit: 2Bit
- Transmission Speed: 38,400
- H/W Type: RS-485
- Sum Check: Selected.
- Transmission Control Procedure: Form4 (With CR, LF)

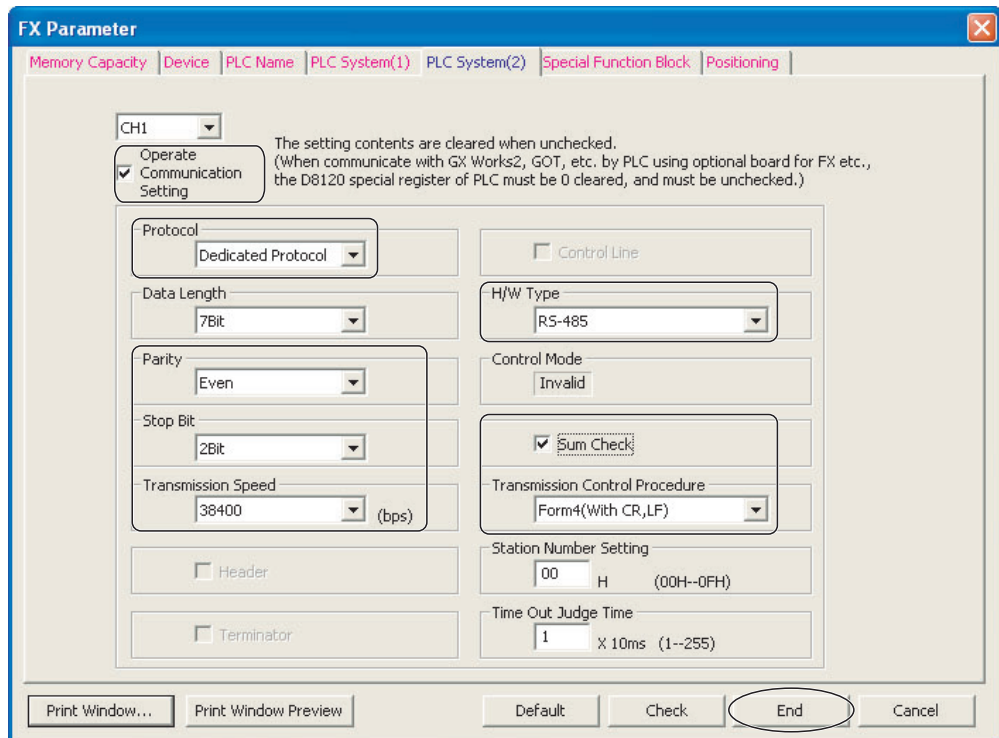

Note: If you change the station number setting, refer to *6-2-7 Communications Node Number*

(3) Select **Online - Write to PLC**. A dialog box to write the set values will be displayed.

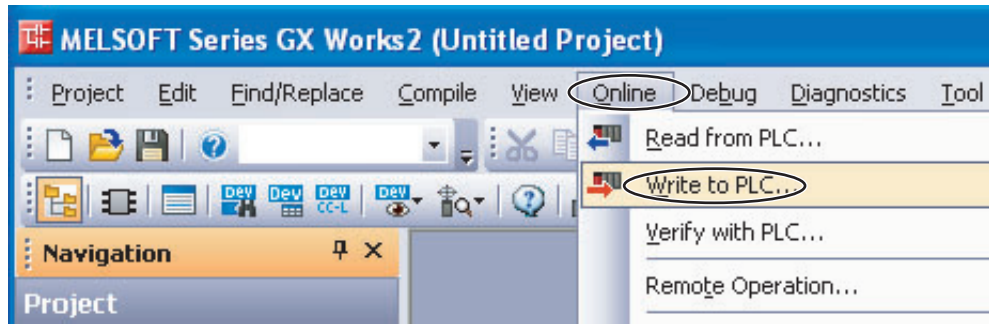

(4) We will write set values to the PLC.

Confirm that **PC Parameters** is selected and click the **Execute** Button.

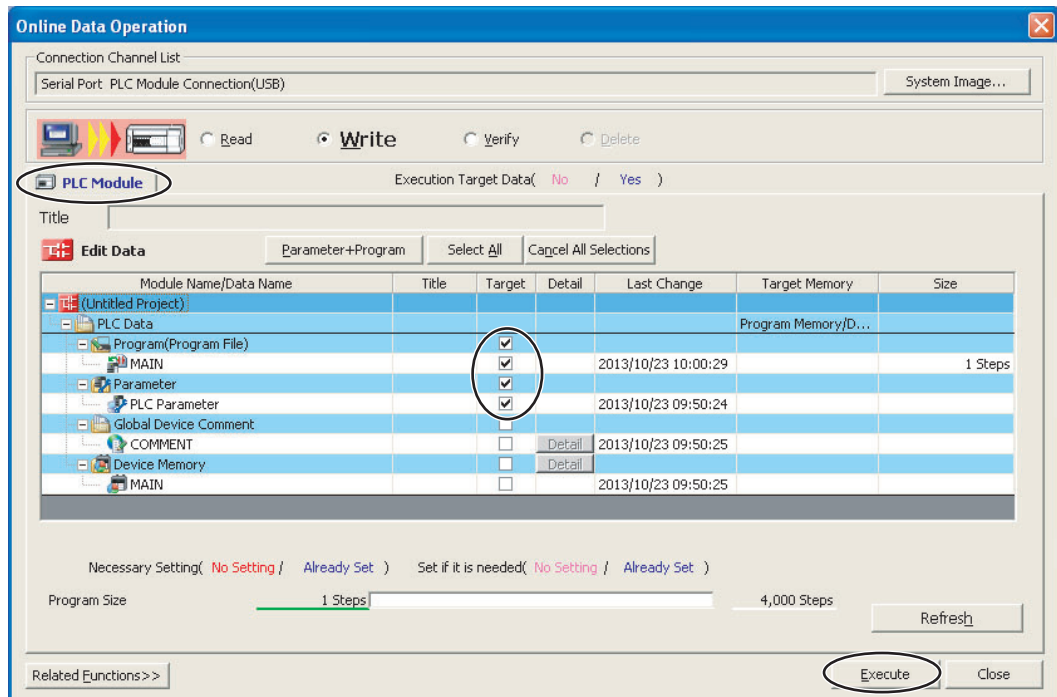

**(5) We will write set values to the PLC.**

When the following dialog box is displayed, click the **Close** Button to close it and cycle the power to the PLC.

This completes the PLC setup procedure. You will use GX Works2 to check operation, so leave it online.

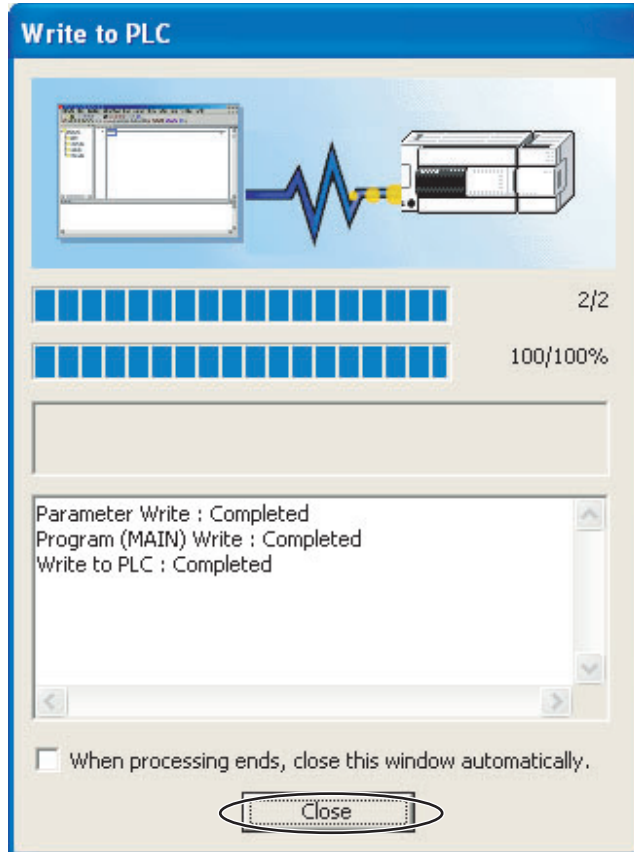
**6-7-4 E5□C Controller Setup**

Set up programless communications. Perform the procedure that is given in 6-4-4 *E5@C Controller Setup*.

**6-7-5 Checking Operation**

Perform the checking operation given in 6-6-5 *Checking Operation*.

## 6-8 Connecting to Keyence KV-series PLCs

This function is supported only for E5□C version 2.1 or later.

### 6-8-1 Configuration and Procedure

The following configuration is used as an example in giving the setup and application procedures for programless communications.

- All of the E5CC Controllers must be the same model. (Copying parameter settings is not possible if the models are different.)
- DM0 to DM89 are used in the PLC memory. The default E5CC parameter allocations are used.
- A commercially available USB2.0, A/B cable is used.

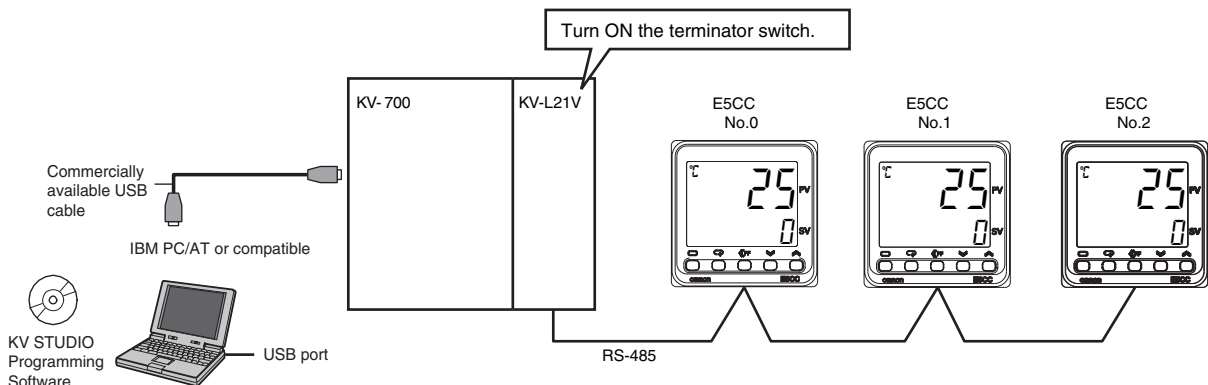

Note: Refer to the *KV STUDIO User's Manual* for the installation procedures for the KV STUDIO and USB driver.

The application procedure is given below.

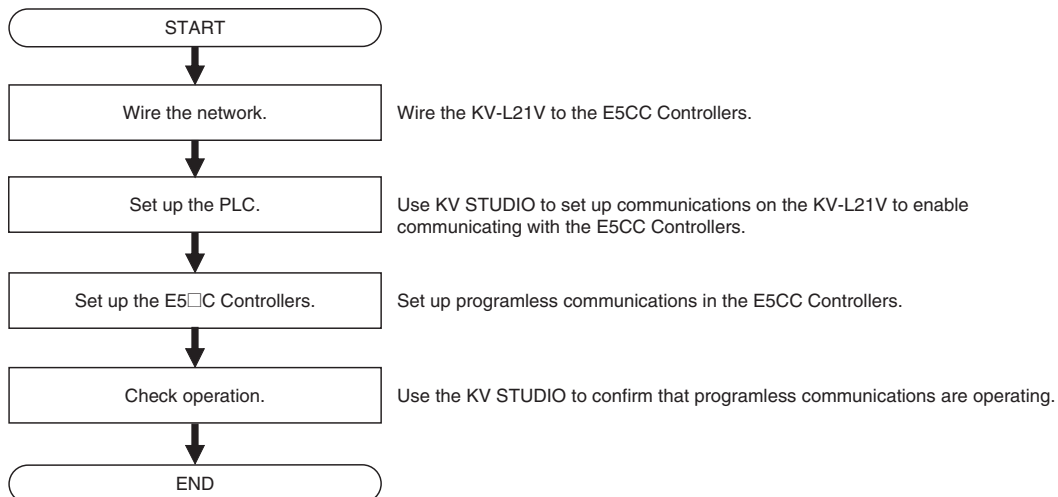

## 6-8-2 Wiring

Set the terminator switch on the front panel of the KV-L21V to TERM and wire the E5CC Controllers as shown below.

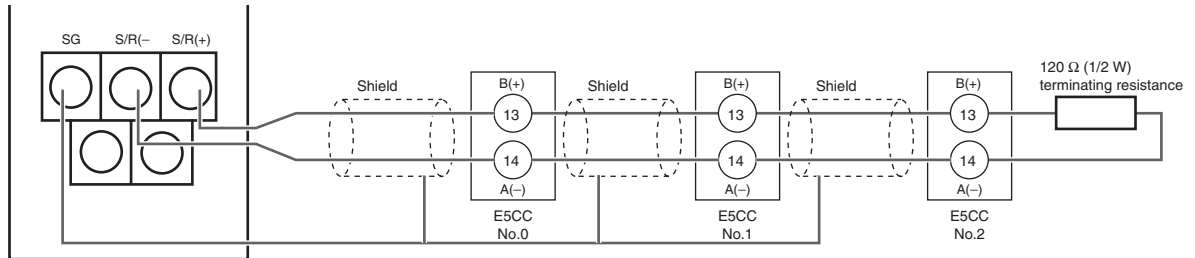

- Note:
- 1 Use a terminating resistance of at least 54  $\Omega$ .
  - 2 The maximum transmission distance is 500 m.
  - 3 For wiring methods, refer to 2-6 *Connecting External Devices* in the *KV-L21V Serial Communication Unit User's Manual* (254GB).

## 6-8-3 PLC Setup

Set up communications on the KV-L21V to enable communicating with the E5CC Controllers. The procedure to use when you create a new project is given below. If you use an existing project, set up communications after you read the data from the PLC.

- (1) **Connect the computer to the KV-series CPU Module with a USB cable and then start KV STUDIO.**
- (2) **Select *Communication Setup – Communication Settings* from the Monitor/Simulator Menu on the KV STUDIO.**  
When the communications setup is displayed, select *USB* for the computer communications port and click the **OK** Button.
- (3) **Select *New Project* from the File Menu, specify the KV-700, enter a project name, and click the **OK** Button.**
- (4) **A Unit Configuration Confirmation Dialog Box will be displayed. Click *Read Unit Configuration*.**
- (5) **The Unit Editor will be displayed. Double-click the KV-L21V and click the *Unit Setup (2) Tab*. Make the following settings for port 2 and click the **OK** Button. Use the default values for other settings.**
  - Operating mode: Protocol mode 4
  - Interface: RS-485 (2-wire)
  - Baud rate: 57,600 bps
  - Data bits: 7 bits
  - Stop bits: 2 bits
  - Checksum: Use
- (6) **Select *PLC Transfer* from the Monitor/Simulator Menu to write the settings.**
- (7) **The Program Transfer Dialog Box will be displayed. Click the **Execute** Button. The settings will be written.**  
This completes setting up the PLC. Operation will be checked next, so leave the KV STUDIO running.

### 6-8-4 E5□C Controller Setup

Set up programless communications. Perform the procedure that is given in *6-4-4 E5@C Controller Setup*.

### 6-8-5 Checking Operation

The SP and RUN/STOP status of the E5□C Controllers will be changed to check operation. Make sure that this will not create any problems in the controlled system.

#### ● Checking E5CC Monitor Values

**(1) Place the PLC into Monitor Mode.**

Select *Monitor Mode* from the Monitor/Simulator Menu on the KV STUDIO.

**(2) The PLC Memory Dialog Box will be displayed.**

Select *Batch Monitor Mode* from the Monitor/Simulator Menu on the KV STUDIO.

**(3) Change the display format to make the values easier to check.**

Select the first display format and change it to *Signed decimal 16 bits*.

**(4) We will check the E5CC monitor values.**

The area where monitor values are checked is called the upload area.

DM0 to DM14 is the upload area for the No. 0 Controller, DM30 to DM44 is the upload area for the No. 1 Controller, and DM60 to DM74 is the upload area for the No. 2 Controller.

With the default settings, the following parameters are set for the upload areas. Check the values in the upload areas to see if they are the same as those that are given in the following table. (It is not necessary to check address for which “---” is given in the Value column.)

No.0	No.1	No.2	Parameter	Value
DM0	DM30	DM60	Response Flag (fixed)	0
DM1	DM31	DM61	Communications Status (fixed)	Alternates between 0 and 1.
DM2	DM32	DM62	Communications Monitor Parameter	---
DM3	DM33	DM63	Status (Upper Word)	---
DM4	DM34	DM64	Status (Lower Word)	---
DM5	DM35	DM65	Status 2 (Upper Word)	---
DM6	DM36	DM66	Decimal Point Monitor	---
DM7	DM37	DM67	Process Value	Process Value *
DM8	DM38	DM68	Internal Set Point	---
DM9	DM39	DM69	Heater Current 1 Value Monitor	---
DM10	DM40	DM70	MV Monitor (Heating)	---
DM11	DM41	DM71	Not used.	---
...	...	...	...	...
DM13	DM43	DM73	Not used.	---
DM14	DM44	DM74	Do not use (reserved).	---

\* If the default settings are used and a sensor is not connected, the PV display on the E5CC will show an input error (*S.ERR*) and the process value in the upload area will be 1320 (528 hex).

## ● Changing E5CC Settings

### (1) We will check the area that is used to change E5CC set values.

The area that is used to change the set value is called the download area.

DM15 to DM29 is the download area for the No. 0 Controller, DM45 to DM59 is the download area for the No. 1 Controller, and DM75 to DM89 is the download area for the No. 2 Controller.

With the default settings, the following parameters are set for the download areas.

No.0	No.1	No.2	Parameter	Value (E5CC default settings)
DM15	DM45	DM75	Request Flag (fixed)	1 (0001 hex)
DM16	DM46	DM76	Operation Command Code (fixed)	0 (0000 hex)
DM17	DM47	DM77	Set Point	0 (0000 hex)
DM18	DM48	DM78	Proportional Band	80 (0050 hex)
DM19	DM49	DM79	Integral Time	233 (00E9 hex)
DM20	DM50	DM80	Derivative Time	40 (0028 hex)
DM21	DM51	DM81	Alarm Value 1	0 (0000 hex)
DM22	DM52	DM82	Alarm Value Upper Limit 1	0 (0000 hex)
DM23	DM53	DM83	Alarm Value Lower Limit 1	0 (0000 hex)
DM24	DM54	DM84	Alarm Value 2	0 (0000 hex)
DM25	DM55	DM85	Alarm Value Upper Limit 2	0 (0000 hex)
DM26	DM56	DM86	Alarm Value Lower Limit 2	0 (0000 hex)
DM27	DM57	DM87	Heater Burnout Detection 1	0 (0000 hex)
DM28	DM58	DM88	Process Value Input Shift	0 (0000 hex)
DM29	DM59	DM89	SP Ramp Set Value	0 (0000 hex)

**(2) We will initialize the download areas with the set values from the E5CC Controllers.**

The download areas have not been initialized, so we will initialize them with the set values from the E5CC Controllers.

Double-click **DM15** (Request Flag) on the Batch Monitor Dialog Box, enter 2 (Initialize Download Areas), and press the **Enter** Key.

**(3) We will confirm that the download areas have been initialized.**

When initialization is completed, DM0 (Response Flag) will change to 1 (Normal End) and DM15 (Request Flag) will automatically change to 1 (Enable Writing). Check the download area to see if it has been initialized to the values given in the above table.

Confirm this for the No. 1 and No. 2 Controllers as well.

**(4) We will change the set point for the No. 0 Controller.**

Double-click **DM17** (Set Point) on the Batch Monitor Dialog Box, enter 100 (64 hex) as the value, and press the **Enter** Key. Confirm that DM0 (Request Flag) remains at 1 (Enable Writing) and that the SV Display on the No. 0 Controller changes to 100.

Confirm this for the No. 1 and No. 2 Controllers as well.

## ● Stopping the E5CC Controllers

**(1) We will run the No. 0 Controller.**

Change the RUN/STOP parameter ( $R-5$ ) in the operation level of the E5CC to RUN ( $RUN$ ). For a Controller with event inputs, the Event Input 2 Assignment parameter ( $EV-2$ ) in the initial setting level is set to RUN/STOP ( $STOP$ ), so the RUN/STOP parameter will not be displayed. Change the Event Input 2 Assignment parameter to NONE ( $NONE$ ), and then change the RUN/STOP parameter to RUN.

**(2) We will switch the No. 0 Controller to STOP.**

Change the display format to *Hexadecimal 16 bit* on the Batch Monitor Dialog Box. Then, confirm that DM15 (Request Flag) is 1 (Enable Writing), double-click **DM16** (Operation Command Code), enter 0101 hex (Stop), and press the **Enter** Key.

DM16 will change to 0, DM0 (Response Flag) will remain at 1 (Enable Writing), and "STOP" will be displayed on the No. 0 Controller.



Confirm this for the No. 1 and No. 2 Controllers as well.

For details on other operation command codes, refer to *6-3-4 Operation Command Codes*.





# Component Communications

This section describes component communications for the E5□C.  
Component communications are not supported by version 1.0 of the E5CC/EC.

---

<b>7-1</b>	<b>Component Communications</b>	<b>7-2</b>
7-1-1	Introduction	7-2
7-1-2	Wiring	7-2
7-1-3	E5□C Setup	7-3
<b>7-2</b>	<b>Operation for Component Communications</b>	<b>7-5</b>
<b>7-3</b>	<b>Troubleshooting</b>	<b>7-6</b>

# 7-1 Component Communications

## 7-1-1 Introduction

You can use component communications to connect two or more E5□C Controllers via RS-485 and then change the set points or RUN/STOP status for all of the Controllers at the same time. If you change the set point or RUN/STOP status of the master (i.e., the Controller with a communications unit number of 0), the set points or RUN/STOP status of all of the slaves (i.e., the Controllers with communications unit numbers other than 0) that are connected via RS-485 will change automatically. When you change the set points, the set point from the master can be multiplied by a factor or offset at each slave. You can also copy the parameter settings in the master to the slaves.

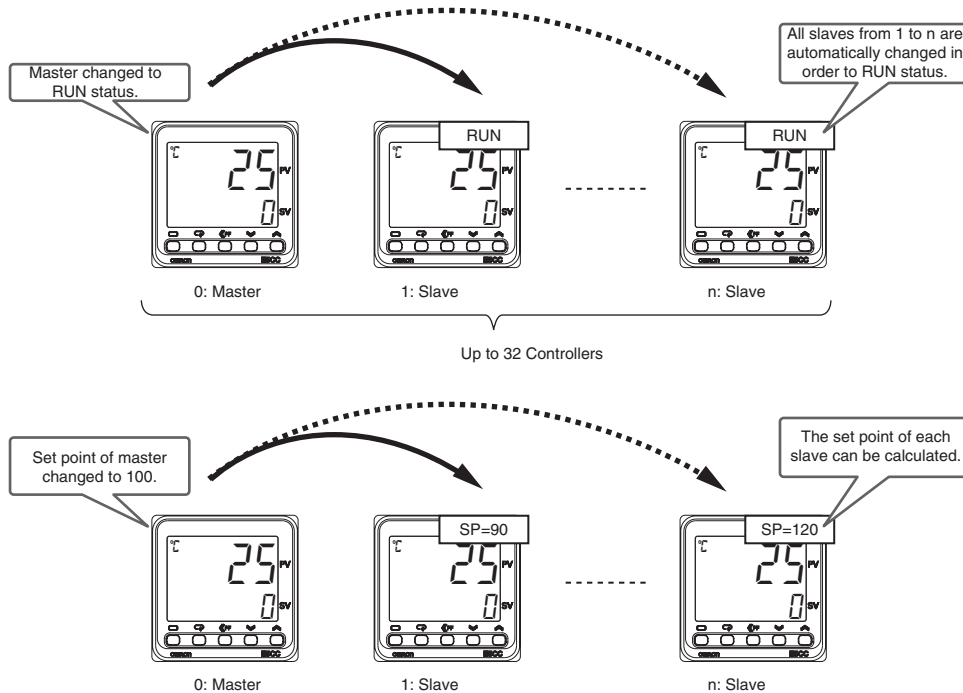

Note: To use component communications, the input type and, if an analog input is used, the decimal point position must be set to the same values for all of the E5□C Controllers. The operation will not work correctly if the position of the decimal point is different.

## 7-1-2 Wiring

Wire the E5□C Controllers as shown below.

### E5CC/EC/AC

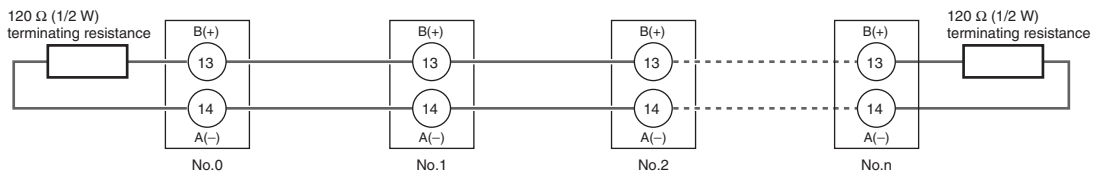

### E5DC

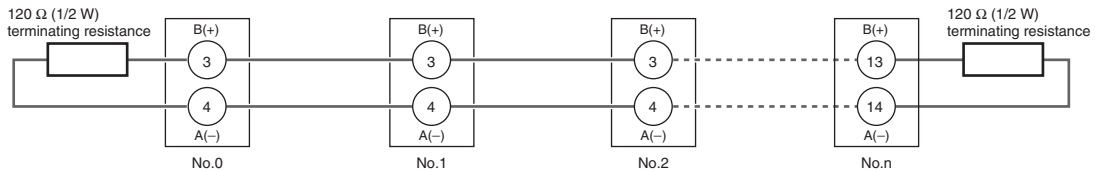

E5GC

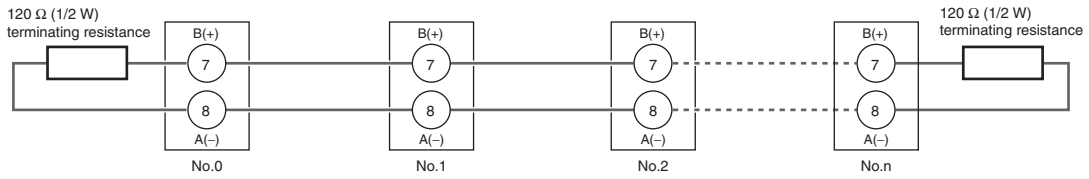

7-1-3 E5□C Setup

The parameters that are used for component communications are shown with a gray background in the following diagram. All of these parameters are displayed if you set the Protocol Setting parameter to *EMP*. (Some of the parameters are always displayed.)

This section describes the parameters that are used to calculate the set point. The other parameters are the same as for programless communications. Refer to 6-2 *E5@C Setup*. To use component communications, the input type and, if an analog input is used, the decimal point position must be set to the same values for all of the E5□C Controllers. The operation will not work correctly if the position of the decimal point is different.

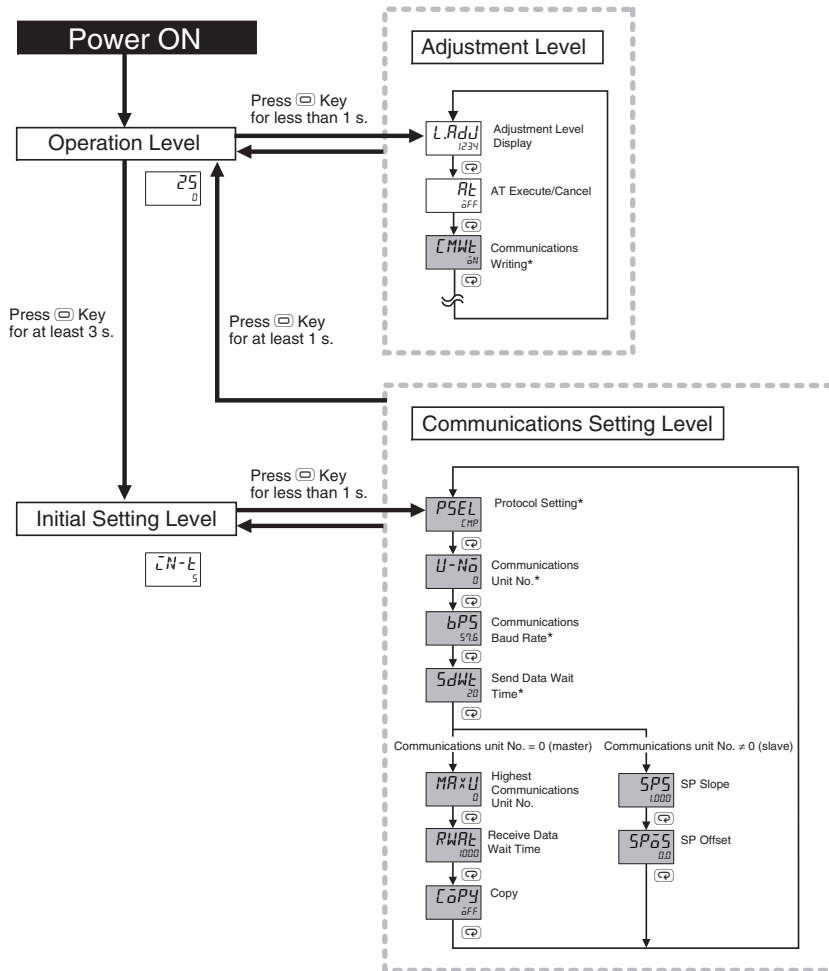

\* These parameters are displayed regardless of the setting of the Protocol Setting parameter.  
 Note: The Communications Data Length, Communications Stop Bits, and Communications Parity parameters in the communications setting level are not displayed.

## SP Calculations

The set point (SP) of a slave can be calculated from the set point of the master as shown below. The slave performs the calculation only during operation. The value is not written to the slave if it exceeds the set point limiter.

During operation: Slave SP = Master SP × SP Slope + SP Offset

When stopped: Slave SP = Master SP

Communications Setting Level

Display condition: The Protocol Setting parameter must be set to  $\overline{MP}$  and the Communications Unit No. parameter must not be set to 0 (0 = master).

Parameter name	Displayed characters	Setting range	Unit	Default
SP Slope	$\overline{SPS}$	0.001 to 9.999	None	1.000
SP Offset	$\overline{SPoS}$	Temperature input: -199.9 to 999.9 Analog input: -1,999 to 9,999*	EU	0.0

\* The decimal point position depends on the Decimal Point parameter setting.

## 7-2 Operation for Component Communications

Only two parameter settings can be sent from the master to the slaves: the Set Point (SP) and the RUN/STOP parameters.

If the set point or the RUN/STOP status is changed at the master, the new value is sent to the slaves starting with the slave with communications unit number 1 and continuing on to the slave with the highest communications unit number. The master sends values only during operation. Values are not sent while in the initial setting level.

If the set point or the RUN/STOP status is changed again while sending a previous value to the slaves, the original value will not be transferred correctly. Always wait for a value to be sent to all of the slaves before you change the set point or RUN/STOP status again.

Levels		Component communications
Operation level, adjustment level, manual control level, monitor/setting item level, and protect level	Setting area 0	Operates
Initial setting level, communications setting level, advanced function setting level, and calibration level	Setting area 1	Stops

For component communications, the master sends the value in order starting from slave 1. There will be a delay of up to 30 ms between when the set point or RUN/STOP status is sent to all of the slaves. If this delay is too long, consider using event inputs to change the set points or to change the RUN/STOP status.

If communications with a slave fail, the master will retry communications twice. If communications still fail, it will move to processing the next slave. To see if the value was sent correctly, check the display of the Set Point or STOP parameter on each slave.

### ● Exception Processing

<b>Master</b>	<ul style="list-style-type: none"> <li>• If the multi-SP is changed, the set point is sent to each slave.</li> <li>• This function is disabled in the following cases:               <ul style="list-style-type: none"> <li>• During operation with a remote SP</li> <li>• When changing the set point for SP tracking</li> </ul> </li> </ul>
<b>Slaves</b>	<ul style="list-style-type: none"> <li>• SPs are not calculated when operation is stopped.</li> <li>• The value from the master is not received in the following cases:               <ul style="list-style-type: none"> <li>• When the set point from the master or the results of set point calculation exceeds the set point limiter of the slave.</li> <li>• When Communications Writing parameter is set to "OFF"</li> <li>• When RUN/STOP is assigned to an event input (Changes in the set point will be received.)</li> </ul> </li> <li>• When a communications error occurs three times in a row</li> </ul>

## 7-3 Troubleshooting

Possible problems that can occur with component communications and corrective actions are given in the following table.

Status	Cause and corrective action	Page
The set point or RUN/STOP status will not change for a slave (i.e., a Controller with a communications unit number other than 0).	The wiring to the slave is not correct.	7-2
	The communications settings for the slave are not correct. <ul style="list-style-type: none"> <li>• The Protocol Setting parameter is not set to <math>\overline{MP}</math>.</li> <li>• The Communications Unit No. parameter is set to the same value as another slave.</li> <li>• The setting of the Communications Baud Rate parameter is not the same as the other slaves.</li> <li>• The Highest Communications Unit No. parameter is not set to the highest communications unit number that is actually set.</li> <li>• The Communications Writing parameter is set to OFF.</li> </ul>	7-3
	◆ When the RUN/STOP Does Not Change RUN/STOP is assigned to an event input for the slave.	7-5
	◆ When the Set Point Does Not Change The set point from the master or the results of set point calculations exceeds the set point limiter of the slave.	7-4 7-5
The set points or the RUN/STOP status will not change for any of the slaves.	The wiring to the master (i.e., the Controller with communications unit number 0) is not correct.	7-2
	The communications settings in the master are not correct. <ul style="list-style-type: none"> <li>• The Protocol Setting parameter is not set to <math>\overline{MP}</math>.</li> <li>• The Communications Unit No. parameter is not set to 0.</li> <li>• The Communications Baud Rate parameter is not set to the same value as the slaves.</li> <li>• The Highest Communications Unit No. parameter is not set to the highest communications unit number that is actually set.</li> </ul>	7-3
The set point is not calculated.	<ul style="list-style-type: none"> <li>• The SP Slope or SP Offset parameter is not set correctly.</li> <li>• The set point was changed at the master when the slave was stopped (setting area 1).</li> </ul>	7-4
It is sometimes not possible to change the set points or RUN/STOP status.	There may be noise interference. Connect terminating resistance to both ends of the communications line.	7-2

Note: For information on other problems, refer to *A-2 Troubleshooting*.



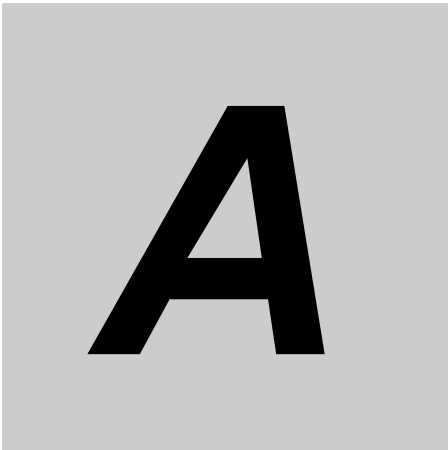

# Appendices

---

---

A-1 ASCII List .....	A-2
A-2 Troubleshooting .....	A-3



# A-1 ASCII List

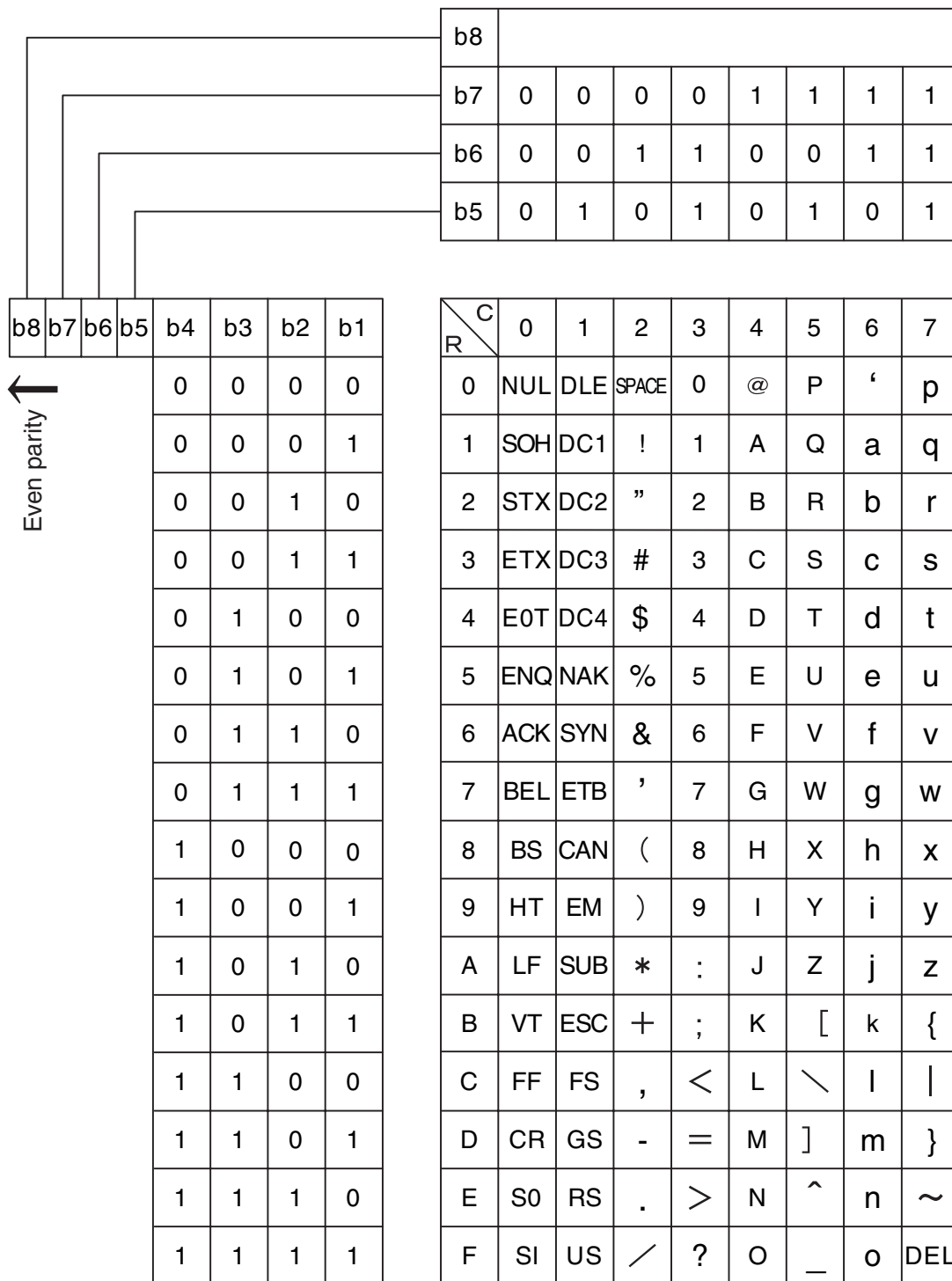

## A-2 Troubleshooting

### Before Requesting Repairs

If communications are not functioning properly, check the items in the following table before requesting repairs. If normal operation cannot be restored even after checking everything, return the product to your OMRON representative.

#### Problem: Communications are not possible or communications errors occur.

Item	Confirmation	Page
The communications wiring is not correct.	Correct the wiring.	1-4
The communications line has become disconnected.	Connect the communications line securely and tighten the screws.	---
The communications cable is broken.	Replace the cable.	---
The communications cable is too long.	The total cable length is 500 m maximum for RS-485 communications.	1-4
The wrong communications cable has been used.	Use a shielded, AWG24 to AWG18 (cross-sectional area of 0.205 to 0.823 mm <sup>2</sup> ) twisted-pair cable for the communications cable.	1-4
Too many communications devices are connected to the communications path.	When 1:N, RS-485 communications are used, a maximum of 32 nodes may be connected, including the host node.	1-4
An end node has not been set at each end of the communications line.	Set or connect terminating resistance at each end of the line. If the E5□C is the end node, 120-Ω (1/2-W) terminating resistance is used. Be sure that the combined resistance with the host device is 54 Ω minimum.	1-4
The specified power supply voltage is not being supplied to the Controller.	Supply the specified power supply voltage.	---
The specified power supply voltage is not being supplied to an Interface Converter (e.g., the K3SC).	Supply the specified power supply voltage.	---
The same baud rate and communications method are not being used by all of the Controllers, host devices, and other nodes on the same communications line.	Set the same values for the following on all nodes: baud rate, protocol, data length, stop bits, and parity.	1-2
The unit number specified in the command frame is different from the unit number set for the Controller.	Use the same unit number.	2-2 4-2
The same unit number as the Controller is being used for another node on the same communications line.	Set each unit number for only one node.	1-4
There is a mistake in programming in the host device.	Use a line monitor to check the commands.	---
The host device is detecting the absence of a response as an error before it receives the response from the Controller.	Shorten the send data wait time in the Controller or increase the response wait time in the host device.	1-5

Item	Confirmation	Page
The host device is detecting the absence of a response as an error after broadcasting a command or sending a software reset command.	The Controller does not return responses for broadcast or software reset commands.	2-2 2-17 4-2 4-14
The host device sent another command before receiving a response from the Controller.	Always read the response after sending a command (except for broadcast or software reset commands).	---
The host device sent the next command too soon after receiving a response from the Controller.	Wait for at least 2 ms after receiving a response before sending the next command.	1-2
The communications line became unstable when the Controller's power was turned ON or interrupted, and the host device read the unstable status as data.	Initialize the reception buffer in the host device before sending the first command and after turning OFF the power to the Controller.	---
The communications data was corrupted by noise from the environment.	Try using a slower baud rate. Separate the communications cable from the source of noise. Use a shielded, twisted-pair cable for the communications cable. Use as short a communications cable as possible and do not lay or loop extra cable. Do not run the communications cable parallel to a power line to prevent inductive noise. If noise countermeasures are difficult to implement, use an Optical Interface.	---



# Index



# Index

---

<b>A</b>	
<hr/>	
addresses	
CompoWay/F .....	2-7
Modbus .....	4-7
area definitions .....	2-6
areas and first address of linked data .....	6-8
ASCII list .....	A-2
<b>B</b>	
<hr/>	
BCC .....	2-2, 2-3
<b>C</b>	
<hr/>	
command frame	
CompoWay/F .....	2-2
Modbus .....	4-2
command text .....	2-2
communications baud rate .....	1-6, 1-8, 6-7
communications data	
CompoWay/F .....	2-4, 3-1
Modbus .....	5-1
communications data length .....	1-6, 1-8
communications monitor .....	6-16
communications node number .....	6-10
communications parameter setup .....	1-7
communications parameters .....	1-6
communications parity .....	1-6, 1-8
communications protocol .....	1-6, 1-8
communications specifications .....	1-2
communications stop bits .....	1-6, 1-8
communications unit No. ....	6-7
communications unit number .....	1-6, 1-8
communications writing .....	6-15
component communications .....	7-2
Composite Read from Variable Area (CompoWay/F) .....	2-7, 2-10
Composite Write to Variable Area (CompoWay/F) .....	2-7, 2-12
CompoWay/F .....	1-2, 2-1, 3-1
confirming operation of programless communications .....	6-19
copying parameter settings .....	6-13
CRC-16 .....	4-2, 4-3
<b>D</b>	
<hr/>	
data .....	4-2
data format	
CompoWay/F .....	2-2
Modbus .....	4-2
dedicated protocol (format 4) .....	6-6, 6-9
description of communications parameters .....	1-8
double-word data .....	3-2
<b>E</b>	
<hr/>	
Echoback Test	
CompoWay/F .....	2-7, 2-15
Modbus .....	4-6, 4-15
end codes	
CompoWay/F .....	2-3, 2-4
error codes	
Modbus .....	4-5
ETX .....	2-2
<b>F</b>	
<hr/>	
FINS .....	1-2
Four-byte Mode .....	4-7, 5-2
function code .....	4-2
functions (Modbus)	
detailed description .....	4-8
list .....	4-6
<b>H</b>	
<hr/>	
highest communications unit No. ....	6-7
Host Link (FINS) .....	6-6, 6-9
<b>I</b>	
<hr/>	
interface .....	1-3
<b>M</b>	
<hr/>	
MC protocol (format 4) .....	6-6, 6-9
Modbus .....	1-2, 4-1, 5-1
<b>N</b>	
<hr/>	
no response .....	4-5
node number .....	2-2
number of elements	
CompoWay/F .....	2-7
Modbus .....	4-7
<b>O</b>	
<hr/>	
operation command	
CompoWay/F .....	2-7
Modbus .....	4-12
operation command codes .....	6-19
<b>P</b>	
<hr/>	
PDU structure .....	2-6

PLC .....	6-5
programless communications .....	6-3
protocol setting .....	1-8, 6-6

## R

---

range of operation for programless communications .....	6-19
Read Controller Attributes (CompoWay/F) .....	2-7, 2-13
Read Controller Status (CompoWay/F) .....	2-7, 2-14
Read Variable Area (CompoWay/F) .....	2-7, 2-8
receive data wait time .....	6-10
Request Flag .....	6-17
response code list (CompoWay/F) .....	2-21
Response Flag .....	6-18
response frame	
CompoWay/F .....	2-3
Modbus .....	4-4
RS-485 .....	1-4

## S

---

send data wait time .....	1-6, 1-8, 6-7
services (CompoWay/F)	
detailed description .....	2-8
list .....	2-7
set values (Modbus) .....	4-7
SID .....	2-2
single-word data .....	3-2
slave address .....	4-2
SP calculations .....	7-4
Status	
CompoWay/F .....	3-22
Modbus .....	5-17
Status 2 (CompoWay/F) .....	3-22
STX .....	2-2
sub-address .....	2-2

## T

---

transmission procedure .....	1-3
troubleshooting .....	A-3
troubleshooting during component communications .....	7-6
troubleshooting during copying operation	
under programless communications .....	6-14
troubleshooting during programless communications .....	6-20
Two-byte Mode .....	4-7, 5-2
type code (variable type) .....	2-6

## U

---

upload settings and download settings .....	6-11
---	------

## V

---

variable area .....	4-7
variable area (setting range) list	
CompoWay/F .....	3-2

Modbus .....	5-2
Variable Read, Multiple (Modbus) .....	4-8
variable type .....	2-6
Variable Write, Multiple (Modbus) .....	4-10
Variable Write, Single/Operation Command (Modbus) .....	4-12
versions .....	1-11

## W

---

wiring .....	1-4
Write Mode .....	6-20
Write Variable Area (CompoWay/F) .....	2-7, 2-9

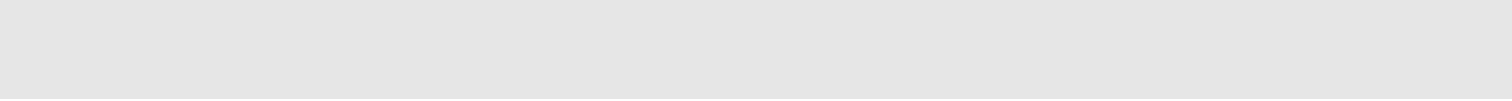





**OMRON Corporation Industrial Automation Company**

Tokyo, JAPAN

Contact: [www.ia.omron.com](http://www.ia.omron.com)

**Regional Headquarters**

**OMRON EUROPE B.V.**

Wegalaan 67-69-2132 JD Hoofddorp  
The Netherlands

Tel: (31)2356-81-300/Fax: (31)2356-81-388

**OMRON ELECTRONICS LLC**

One Commerce Drive Schaumburg,  
IL 60173-5302 U.S.A.

Tel: (1) 847-843-7900/Fax: (1) 847-843-7787

**OMRON ASIA PACIFIC PTE. LTD.**

No. 438A Alexandra Road # 05-05/08 (Lobby 2),  
Alexandra Technopark,  
Singapore 119967

Tel: (65) 6835-3011/Fax: (65) 6835-2711

**OMRON (CHINA) CO., LTD.**

Room 2211, Bank of China Tower,  
200 Yin Cheng Zhong Road,  
PuDong New Area, Shanghai, 200120, China

Tel: (86) 21-5037-2222/Fax: (86) 21-5037-2200

**Authorized Distributor:**

© OMRON Corporation 2011 All Rights Reserved.  
In the interest of product improvement,  
specifications are subject to change without notice.

**Cat. No. H175-E1-08**

0414