



System components for automation technology

Catalog

17



TB20, DISTRIBUTED FIELDBUS I/O SYSTEM

In the TB20-3 catalog, you will find all information and ordering data in regard to our decentralized I/O system TB20.

All brochures are available for download at any time online at www.helmholz.com.

If you would prefer, we can also send you print versions of our catalogs. Simply send a mail to: sales@helmholz.de.

HOW TO REACH US

Phone orders: +49 9135 7380-0

Fax orders: +49 9135 7380-490

ON THE INTERNET

Homepage: www.helmholz.com

E-mail: info@helmholz.de

DON'T MISS OUT ON IMPORTANT INFORMATION!

Sign up for our "Automation Update" newsletter!

You will regularly receive information about our new products, exhibitions, and workshops, as well as important messages in regard to product modifications!



www.helmholz.com

FOLLOW US ON ...



	PAGE
PROFIBUS	7–35
PROFINET	36–41
REMOTE MAINTENANCE	42–56
INFRASTRUCTURE/SECURITY	57–61
NETLINK® GATEWAYS	62–70
CAN BUS	71–81
COMPONENTS FOR THE S7	82–109
INTERFACE CONVERTER	110–118
SERVICE	119–123

Systeme Helmholz®, **EasyConnect**®, FLEXtra® und NETLink® are registered trademarks of Systeme Helmholz GmbH. S7-200, S7-300, S7-400, S7-1200, S7-1500, WinCC, ProTool, Simatic, TIA and STEP are registered trademarks of Siemens AG. All the companies and product names mentioned in this catalog are used solely for identification purposes and are/may be registered trademarks of their respective trademark owners.

Our General Terms and Conditions apply. All information in this catalog, especially with respect to technical values, dimensions, and weights, is subject to change without notice. Errors and omissions excepted. Figures may look different from the original.
Version: November 2015

PROFIBUS

PROFIBUS connectors	
PROFIBUS connector overview.....	8
PROFIBUS connector, 90° screw terminal.....	9
PROFIBUS connector, 35° screw terminal.....	10
PROFIBUS connector, axial cable outlet, screw terminal.....	11
PROFIBUS connector, 90° EasyConnect ®.....	12
PROFIBUS connector, angled EasyConnect ®.....	13
PROFIBUS connectors, axial EasyConnect ®.....	14
PROFIBUS connector, 90° diagnosis EasyConnect ®.....	15
PROFIBUS connector, angled diagnosis EasyConnect ®.....	16
PROFIBUS connector, 90° diagnosis, screw terminal.....	17
PROFIBUS connector, 90° M12.....	18
PROFIBUS connector, 90° with ATEX approval, screw terminal.....	19
PROFIBUS repeaters	
FLEXtra® twinRepeater, PROFIBUS repeater.....	20
FLEXtra® multiRepeater 4-way/6-way, PROFIBUS repeater.....	22
PROFIBUS compact repeater.....	24
PROFIBUS FO	
OPTopus, PROFIBUS optical link.....	26
FLEXtra® FO, PROFIBUS optical hub.....	28
PROFIBUS wireless system	
viBlu, PROFIBUS wireless system.....	30
Antennas for NETLink® WLAN and viBlu.....	32
PROFIBUS communication	
DP/DP coupler.....	33
PROFIBUS accessories	
FLEXtra® profiPoint, active termination and measuring point.....	34
Active PROFIBUS connecting cable; PROFIBUS cable, assembled.....	35

PROFINET

PROFINET connector, RJ45, EasyConnect ®, 10/100 Mbps.....	37
PROFINET Switch, 4-port, managed.....	38
PN/CAN Gateway, PROFINET/CANopen®.....	40

REMOTE MAINTENANCE

For each sector the right remote maintenance solution.....	43
REX 100, Ethernet router.....	44
REX 300 Ethernet router.....	46
myREX24, VPN portal.....	48
REX Global SIM; shSMS; WEB2go.....	49
Ordering data for REX Global SIM, myREX24.....	50
SSW7-TS/TS 300	
SSW7-TS, MPI adapter with teleservice function.....	51
SSW7-TS, MPI adapter with modem; analog/GSM.....	52
SSW7-TS PRO, MPI/PROFIBUS adapter with modem; analog/GSM.....	53
TS 300, teleservice module for the S7 rack.....	54
Antennas	
Antennas for GSM/UMTS/LTE.....	56

INFRASTRUCTURE/SECURITY

WALL IE, Industrial Ethernet Bridge and Firewall.....	58
PROFINET Switch, 4-port, managed.....	60

NETLINK® GATEWAYS

Ethernet

NETLink® PRO PoE, PROFIBUS Ethernet gateway.....	63
NETLink® PRO Compact, PROFIBUS Ethernet gateway.....	64

WLAN

NETLink® WLAN, PROFIBUS Ethernet WLAN gateway.....	66
----------------------------------------------------	----

NETLink® PRO family applications

NETLink® PRO family applications.....	68
---------------------------------------	----

USB

NETLink® USB Compact, mini PROFIBUS USB gateway.....	69
------------------------------------------------------	----

OPC

OPC server.....	70
-----------------	----

CAN BUS

Communication modules

CAN 300 PRO, communication module.....	72
CAN 400, communication module.....	74

Software

CAN software.....	75
-------------------	----

Couplers

DP/CAN coupler CANopen® Layer 2.....	76
DP/CAN coupler Layer 2.....	77

Connectors

Bus connector for CAN Bus.....	78
--------------------------------	----

Infrastructure

CAN Bridge, connecting CAN networks.....	79
PN/CAN Gateway, PROFIBUS/CANopen®.....	80

COMPONENTS FOR S7

Memory modules for S7

Memory cards / Micro memory cards.....	83
----------------------------------------	----

Input/output modules for S7

DEA 300, digital input module.....	84
DEA 300, digital output module.....	86
DEA 300, digital input/output module.....	88
DEA 300, digital output module; 2 amperes.....	90
DEA 300, digital output module; relay output, 2 amperes.....	91
DEA 300, digital output module; relay output, 5 amperes.....	92
DEA 300, digital input module; 120/230 V.....	93
AEA 300, analog input module for connecting current transmitters.....	94
AEA 300, analog input module for connecting voltage transmitters.....	95
AEA 300, analog input module for connecting resistance thermometers.....	96
AEA 300, analog input module current transmitter, voltage transmitter, resistors, and resistance thermometers.....	97
AEA 300, analog output module; 4-channel.....	98
AEA 300, analog output module; 2-channel.....	99

Dummymodule.....	100
Communication modules	
SAS 340, serial communication module.....	101
SAS 341, serial communication module.....	102
SAS 341-1, with Modbus RTU driver.....	103
EIB 300, communication module for twisted-pair EIB/KNX.....	104
Front connectors for S7	
FastPlug, front adapter for S7 modules.....	106
Front connector with screw contacts, front connector with EasyConnect ® technology.....	107
Front connector with spring-type terminal, front connector with cables.....	108
Accessories	
Mounting rails, mounting rail adapter for DIN rail.....	109
INTERFACE CONVERTERS	
MPI bus	
SSW7, MPI programming adapter.....	111
SSW7-USB, MPI programming adapter USB.....	112
SSW7-HMI, MPI adapter with HMI protocol.....	113
SSW7-RK512, MPI adapter with RK512 protocol.....	114
S5 interface converters	
SSW5/LAN, S5 Ethernet converter.....	116
SSW5/USB, S5 USB programming cable.....	117
SSW3, interface converter cable.....	118
SERVICE	
Product training.....	120
REX user workshop.....	121
Contacts in Germany.....	122
International contacts.....	123



PROFIBUS

Connectors











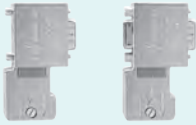





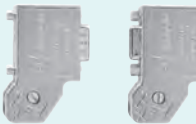















Repeaters

FO

Wireless system

Communication

PROFIBUS connector overview

CONNECTION TECHNOLOGY	ORIENTATION	PRODUCT IMAGE	WITHOUT PG	WITH PG	PAGE
Screw terminal	90°		700-972-0BA12  US	700-972-0BB12  US	9
	90° diagnosis		700-972-7BA12  US	700-972-7BB12  US	17
	35°		700-972-0BA41  US	700-972-0BB41  US	10
	Axial		700-972-0CA12  US		11
	90° with ATEX approval		700-973-0BA12  US	700-973-0BB12  US	19
EasyConnect®	90°		700-972-0BA50  US	700-972-0BB50  US	12
	90° diagnosis		700-972-7BA50  US	700-972-7BB50  US	15
	Angled, for solid cables		700-972-0BA51  US	700-972-0BB51  US	13
	Angled, for flexible cables		700-972-0FA51  US	700-972-0FB51  US	13
	Angled diagnosis, for solid cables			700-972-7BB51	16
	Axial		700-972-0CA50  US		14
M12	90°		700-974-0BA12  US	700-974-0BB12  US	18



PROFIBUS connector 90° with (l.) and without (r.) PG interface

The PROFIBUS connector 90° is equipped with a proven and reliable screw terminal. It is quickly mounted and has integrated, connectable terminating resistors. For improved EMC compatibility, the housing of the plug is metalized. The PROFIBUS connectors also work in the extended ambient temperature range of -25 °C to +85 °C¹.

FEATURES

- Metalized housing
- No parts that can be lost
- Integrated switchable terminating resistor
- 90° cable outlet
- Proven screw terminal



TECHNICAL DATA

PG socket		
Order No. 700-972-0BB12		Yes
Order No. 700-972-0BA12		No
Dimensions in mm (D x W x H)		64 x 40 x 17
Weight		Approx. 40 g
Cable outlet		Vertical cable outlet, suitable for FastConnect wire stripping tool
Terminating resistor		Resistor combination integrated and switchable using slide switch
Transfer rate	max.	12 Mbps
Interfaces		
PROFIBUS participants		SUB-D, 9-pin
Maximum outside diameter		8.0 mm
PROFIBUS cable		60/75 °C copper cable up to 1.0 mm ²
Connector type		4 serial terminals
Supply voltage		4.75 ... 5.25 V DC (must come from the device)
Current draw	max.	12.5 mA
Pollution degree		2
Ambient temperature		-25 °C ... +85 °C ¹
Transport and storage temperature		-25 °C ... +85 °C
Relative humidity	max.	75% at +25 °C
Protection rating		IP 20

ORDERING DATA

ORDER NO.

PROFIBUS connector, 90° without PG socket, screw terminal	700-972-0BA12
with PG socket, screw terminal	700-972-0BB12
Wire stripping tool for PROFIBUS	700-972-6AA00

The PROFIBUS connectors are also available in packs of 10 or 50 pieces.

1) The maximum ambient temperature for UL is 60 °C.

PROFIBUS connector, 35° screw terminal



PROFIBUS connector 35° with (l.) and without (r.) PG interface

The PROFIBUS connector 35° is equipped with a proven and reliable screw terminal. It is quickly mounted and has integrated, connectable terminating resistors.

For improved EMC compatibility, the housing of the plug is metalized.

The PROFIBUS connectors also work in the extended ambient temperature range of -25 °C to +85 °C¹.

FEATURES

- Metalized housing
- No parts that can be lost
- Integrated switchable terminating resistor
- 35° cable outlet
- Proven screw terminal



ORDERING DATA

PROFIBUS connector, 35°
without PG socket, screw terminal
with PG socket, screw terminal

ORDER NO.

700-972-0BA41
700-972-0BB41

TECHNICAL DATA

PG socket		
Order No. 700-972-0BB41		Yes
Order No. 700-972-0BA41		No
Dimensions in mm (D x W x H)		54 x 40 x 17
Weight		Approx. 40 g
Cable outlet		35° angled cable outlet
Terminating resistor		Resistor combination integrated and switchable using slide switch
Transfer rate	max.	12 Mbps
Interfaces		
PROFIBUS participants		SUB-D, 9-pin
Maximum outside diameter		8.0 mm
PROFIBUS cable		60/75 °C copper cable up to 1.0 mm ²
Connector type		4 serial terminals
Supply voltage		4.75 ... 5.25 V DC (must come from the device)
Current draw	max.	12.5 mA
Pollution degree		2
Ambient temperature		-25 °C ... +85 °C ¹
Transport and storage temperature		-25 °C ... +85 °C
Relative humidity	max.	75% at +25 °C
Protection rating		IP 20

The PROFIBUS connectors are also available in packs of 10 or 50 pieces.

1) The maximum ambient temperature for UL is 60 °C.



PROFIBUS connector with axial cable outlet

The PROFIBUS connector with axial cable outlet is equipped with a proven and reliable screw terminal. It is quickly mounted and has integrated, connectable terminating resistors. For improved EMC compatibility, the housing of the plug is metalized. The PROFIBUS connectors also work in the extended ambient temperature range of -25 °C to +85 °C¹.

FEATURES

- Metalized housing
- No parts that can be lost
- Integrated switchable terminating resistor
- Axial cable outlet
- Proven screw terminal



TECHNICAL DATA

Dimensions in mm (D x W x H)	68 x 35 x 17
Weight	Approx. 40 g
Cable outlet	Axial cable outlet, suitable for FastConnect wire stripping tool
Terminating resistor	Resistor combination integrated and switchable using slide switch
Transfer rate	max. 12 Mbps
Interfaces	
PROFIBUS participants	SUB-D, 9-pin
Maximum outside diameter	8.0 mm
PROFIBUS cable	60/75 °C copper cable up to 1.0 mm ²
Connector type	4 serial terminals
Supply voltage	4.75 ... 5.25 V DC (must come from the device)
Current draw	max. 12.5 mA
Pollution degree	2
Ambient temperature	-25 °C ... +85 °C ¹
Transport and storage temperature	-25 °C ... +85 °C
Relative humidity	max. 75% at +25 °C
Protection rating	IP 20

ORDERING DATA

ORDER NO.

PROFIBUS connector, axial Axial cable outlet, screw terminal	700-972-0CA12
Wire stripping tool for PROFIBUS	700-972-6AA00

The PROFIBUS connectors are also available in packs of 10 or 50 pieces.

1) The maximum ambient temperature for UL is 60 °C.

PROFIBUS connector, 90° EasyConnect®



PROFIBUS connector, 90° EasyConnect®

The PROFIBUS connector 90° EasyConnect® features quick-connect technology, making stripping of the bus wires unnecessary. With the aid of a visual connection control, it is also possible to check that the PROFIBUS cable is correctly connected after it is mounted.

For improved EMC compatibility, the housing of the plug is metalized.

The EasyConnect® connectors also work in the extended ambient temperature range of -25 °C to +85 °C¹.

FEATURES

- Metalized housing
- No parts that can be lost
- Integrated switchable terminating resistor
- 90° cable outlet
- Quick-connect technology EasyConnect®
- Visual connection control



TECHNICAL DATA

PG socket		Yes
Order No. 700-972-0BB50		No
Order No. 700-972-0BA50		
Dimensions in mm (D x W x H)		72 x 40 x 17
Weight		Approx. 40 g
Cable outlet		Vertical cable outlet, suitable for FastConnect wire stripping tool
Terminating resistor		Resistor combination integrated and switchable using slide switch
Transfer rate	max.	12 Mbps
Interfaces		
PROFIBUS participants		SUB-D, 9-pin
Maximum outside diameter		8.0 mm
PROFIBUS cable		FC standard cable, solid or flexible; 0.64 mm Ø 60/75 °C copper cable
Connector type		EasyConnect®
Supply voltage		4.75 ... 5.25 V DC (must come from the device)
Current draw	max.	12.5 mA
Pollution degree		2
Ambient temperature		-25 °C ... +85 °C ¹
Transport and storage temperature		-25 °C ... +85 °C
Relative humidity	max.	75% at +25 °C
Protection rating		IP 20

ORDERING DATA

ORDER NO.

PROFIBUS connector, 90° EasyConnect®	
for solid/flexible cable	
without PG socket	700-972-0BA50
with PG socket	700-972-0BB50
Wire stripping tool for PROFIBUS	700-972-6AA00

The PROFIBUS connectors are also available in packs of 10 or 50 pieces.

1) The maximum ambient temperature for UL is 60 °C.



PROFIBUS connector, angled **EasyConnect**[®]

The PROFIBUS connector angled **EasyConnect**[®] features quick-connect technology, making stripping of the bus wires unnecessary.

With the aid of a visual connection control, it is also possible to check that the PROFIBUS cable is correctly connected after it is mounted.

For improved EMC compatibility, the housing of the plug is metalized.

The **EasyConnect**[®] connectors also work in the expanded ambient temperature range of -25 °C to +85 °C¹.

FEATURES

- Metalized housing
- No parts that can be lost
- Integrated switchable terminating resistor
- Angled cable outlet
- Quick-connect technology **EasyConnect**[®]
- Visual connection control



TECHNICAL DATA

PG socket	
Order No. 700-972-0BB51/-0FB51	Yes
Order No. 700-972-0BA51/-0FA51	No
Dimensions in mm (D x W x H)	68 x 60 x 17
Weight	Approx. 50 g
Cable outlet	Angled cable outlet
Terminating resistor	Resistor combination integrated and switchable using slide switch
Transfer rate	max. 12 Mbps
Interfaces	
PROFIBUS participants	SUB-D, 9-pin
Maximum outside diameter	8.0 mm
PROFIBUS cable	FC standard cable, solid or flexible; 0.64 mm Ø 60/75 °C copper cable
Connector type	EasyConnect [®]
Supply voltage	4.75 ... 5.25 V DC (must come from the device)
Current draw	max. 12.5 mA
Pollution degree	2
Ambient temperature	-25 °C ... +85 °C ¹
Transport and storage temperature	-25 °C ... +85 °C
Relative humidity	max. 75% at +25 °C
Protection rating	IP 20

ORDERING DATA

ORDER NO.

PROFIBUS connector, angled EasyConnect[®] for solid cable without PG socket with PG socket	700-972-0BA51 700-972-0BB51
PROFIBUS connectors angled EasyConnect[®] for flexible cable without PG socket with PG socket	700-972-0FA51 700-972-0FB51

The PROFIBUS connectors are also available in packs of 10 or 50 pieces.

1) The maximum ambient temperature for UL is 60 °C.



PROFIBUS connectors, axial **EasyConnect**[®]

The PROFIBUS connector axial **EasyConnect**[®] features quick-connect technology, making stripping of the bus wires unnecessary. With the aid of a visual connection control, it is also possible to check that the PROFIBUS cable is correctly connected after it is mounted.

For improved EMC compatibility, the housing of the plug is metalized.

The **EasyConnect**[®] connectors also work in the expanded ambient temperature range of -25 °C to +85 °C¹.

FEATURES

- Metalized housing
- No parts that can be lost
- Integrated switchable terminating resistor
- Axial cable outlet
- Quick-connect technology **EasyConnect**[®]
- Visual connection control



ORDERING DATA

PROFIBUS connector, axial EasyConnect[®] for solid/flexible cable	700-972-0CA50
Wire stripping tool for PROFIBUS	700-972-6AA00

ORDER NO.

TECHNICAL DATA

Dimensions in mm (D x W x H)	70 x 35 x 17
Weight	Approx. 50 g
Cable outlet	Vertical cable outlet, suitable for FastConnect wire stripping tool
Terminating resistor	Resistor combination integrated and switchable using slide switch
Transfer rate	max. 12 Mbps
Interfaces PROFIBUS participants	SUB-D, 9-pin
Maximum outside diameter	8.0 mm
PROFIBUS cable	FC standard cable, solid or flexible; 0.64 mm Ø 60/75 °C copper cable
Connector type	EasyConnect [®]
Supply voltage	4.75 ... 5.25 V DC (must come from the device)
Current draw	max. 12.5 mA
Pollution degree	2
Ambient temperature	-25 °C ... +85 °C ¹
Transport and storage temperature	-25 °C ... +85 °C
Relative humidity	max. 75% at +25 °C
Protection rating	IP 20

The PROFIBUS connectors are also available in packs of 10 or 50 pieces.

1) The maximum ambient temperature for UL is 60 °C.



PROFIBUS connector, 90° diagnosis **EasyConnect®**

The PROFIBUS connector 90° **EasyConnect®** diagnosis features quick-connect technology, making stripping of the bus wires unnecessary.

With the aid of a visual connection control, it is also possible to check that the PROFIBUS cable is correctly connected after it is mounted.

For improved EMC compatibility, the housing of the plug is metalized.

Using the PROFIBUS connector diagnosis, a PROFIBUS network can be established in which the user can at any time check the state of the bus system at a glance.

The three built-in LEDs with the easily distinguished colors blue, green, and orange indicate the most important states of the PROFIBUS network at each station. The state of the terminating resistor (orange), whether bus activity is present (green) and whether the addressed participant is participating in the bus traffic (blue) are displayed.

In this way you can immediately recognize error states such as bus interrupts, missing or incorrectly connected terminating resistors, and malfunctioning or failed bus participants.

The **EasyConnect®** connectors also work in the expanded ambient temperature range of -25 °C to +85 °C¹.

FEATURES

- 3 status LEDs to indicate “bus operation,” “participant is sending,” “terminating resistor inserted”
- Metalized housing
- No parts that can be lost
- Integrated switchable terminating resistor
- 90° cable outlet
- Quick-connect technology **EasyConnect®**
- Visual connection control



TECHNICAL DATA

PG socket		
Order No. 700-972-7BB50		Yes
Order No. 700-972-7BA50		No
Dimensions in mm (D x W x H)		72 x 40 x 17
Weight		Approx. 40 g
Cable outlet		Vertical cable outlet, suitable for FastConnect wire stripping tool
Terminating resistor		Resistor combination integrated and switchable using slide switch
Transfer rate	max.	12 Mbps
Interfaces		
PROFIBUS participants		SUB-D, 9-pin
Maximum outside diameter		8.0 mm
PROFIBUS cable		FC standard cable, solid or flexible; 0.64 mm Ø 60/75 °C copper cable
Connector type		EasyConnect®
Supply voltage		4.75 ... 5.25 V DC (must come from the device)
Current draw	max.	35 mA
Pollution degree		2
Ambient temperature		-25 °C ... +85 °C ¹⁾
Transport and storage temperature		-25 °C ... +85 °C
Relative humidity	max.	75% at +25 °C
Protection rating		IP 20

ORDERING DATA

ORDER NO.

PROFIBUS connector, 90° diagnosis EasyConnect® for solid/flexible cable without PG socket	700-972-7BA50
with PG socket	700-972-7BB50
Wire stripping tool for PROFIBUS	700-972-6AA00

The PROFIBUS connectors are also available in packs of 10 or 50 pieces.

1) The maximum ambient temperature for UL is 60 °C.

PROFIBUS connector, angled diagnosis **EasyConnect**[®]



PROFIBUS connector, angled diagnosis **EasyConnect**[®]

The PROFIBUS connector, angled **EasyConnect**[®] diagnosis features quick-connect technology, making stripping of the bus wires unnecessary.

With the aid of a visual connection control, it is also possible to check that the PROFIBUS cable is correctly connected after it is mounted.

For improved EMC compatibility, the housing of the plug is metalized.

Using the PROFIBUS connector diagnosis, a PROFIBUS network can be established in which the user can at any time check the state of the bus system at a glance.

The three built-in LEDs with the easily distinguished colors blue, green, and orange indicate the most important states of the PROFIBUS network at each station. The state of the terminating resistor (orange), whether bus activity is present (green) and whether the addressed participant is participating in the bus traffic (blue) are displayed.

In this way you can immediately recognize error states such as bus interrupts, missing or incorrectly connected terminating resistors, and malfunctioning or failed bus participants.

The **EasyConnect**[®] connectors also work in the expanded ambient temperature range of -25 °C to +85 °C.

FEATURES

- 3 status LEDs to indicate “bus operation,” “participant is sending,” “terminating resistor inserted”
- Metalized housing
- No parts that can be lost
- Integrated switchable terminating resistor
- Angled cable outlet
- Quick-connect technology **EasyConnect**[®]
- Visual connection control



ORDERING DATA

PROFIBUS connector, angled diagnosis **EasyConnect[®] for solid cable with PG socket**

ORDER NO.

700-972-7BB51

The PROFIBUS connectors are also available in packs of 10 or 50 pieces.

TECHNICAL DATA

PG socket	Yes
Dimensions in mm (D x W x H)	68 x 60 x 17
Weight	Approx. 50 g
Cable outlet	Angled cable outlet
Terminating resistor	Resistor combination integrated and switchable using slide switch
Transfer rate	max. 12 Mbps
Interfaces	
PROFIBUS participants	SUB-D, 9-pin
Maximum outside diameter	8.0 mm
PROFIBUS cable	FC standard cable, solid, 0.64 mm Ø 60/75 °C copper cable
Connector type	EasyConnect [®]
Supply voltage	4.75 ... 5.25 V DC (must come from the device)
Current draw	max. 35 mA
Pollution degree	2
Ambient temperature	-25 °C ... +85 °C
Transport and storage temperature	-25 °C ... +85 °C
Relative humidity	max. 75% at +25 °C
Protection rating	IP 20



PROFIBUS connector, 90° diagnosis

The PROFIBUS connector 90° diagnosis is equipped with a proven and reliable screw terminal. It is quickly mounted and has integrated, connectable terminating resistors.

For improved EMC compatibility, the housing of the plug is metalized.

Using the PROFIBUS connector diagnosis, a PROFIBUS network can be established in which the user can at any time check the state of the bus system at a glance.

The three built-in LEDs with the easily distinguished colors blue, green, and orange indicate the most important states of the PROFIBUS network at each station. The state of the terminating resistor (orange), whether bus activity is present (green) and whether the addressed participant is participating in the bus traffic (blue) are displayed.

In this way you can immediately recognize error states such as bus interrupts, missing or incorrectly connected terminating resistors, and malfunctioning or failed bus participants.

The PROFIBUS connectors also work in the extended ambient temperature range of -25 °C to +85 °C¹.

FEATURES

- 3 status LEDs to indicate “bus operation,” “participant is sending,” “terminating resistor inserted”
- Metalized housing
- No parts that can be lost
- Integrated switchable terminating resistor
- 90° cable outlet
- Proven screw terminal



TECHNICAL DATA

PG socket		
Order No. 700-972-7BB12		Yes
Order No. 700-972-7BA12		No
Dimensions in mm (D x W x H)		64 x 40 x 17
Weight		Approx. 40 g
Cable outlet		Vertical cable outlet, suitable for FastConnect wire stripping tool
Terminating resistor		Resistor combination integrated and switchable using slide switch
Transfer rate	max.	12 Mbps
Interfaces		
PROFIBUS participants		SUB-D, 9-pin
Maximum outside diameter		8.0 mm
PROFIBUS cable		60/75 °C copper cable up to 1.0 mm ²
Connector type		4 serial terminals
Supply voltage		4.75 ... 5.25 V DC (must come from the device)
Current draw	max.	35 mA
Pollution degree		2
Ambient temperature		-25 °C ... +85 °C ¹
Transport and storage temperature		-25 °C ... +85 °C
Relative humidity	max.	75% at +25 °C
Protection rating		IP 20

ORDERING DATA

ORDER NO.

PROFIBUS connector, 90° diagnosis without PG socket, screw terminal	700-972-7BA12
with PG socket, screw terminal	700-972-7BB12
Wire stripping tool for PROFIBUS	700-972-6AA00

The PROFIBUS connectors are also available in packs of 10 or 50 pieces.

1) The maximum ambient temperature for UL is 60 °C.

PROFIBUS connector, 90° M12

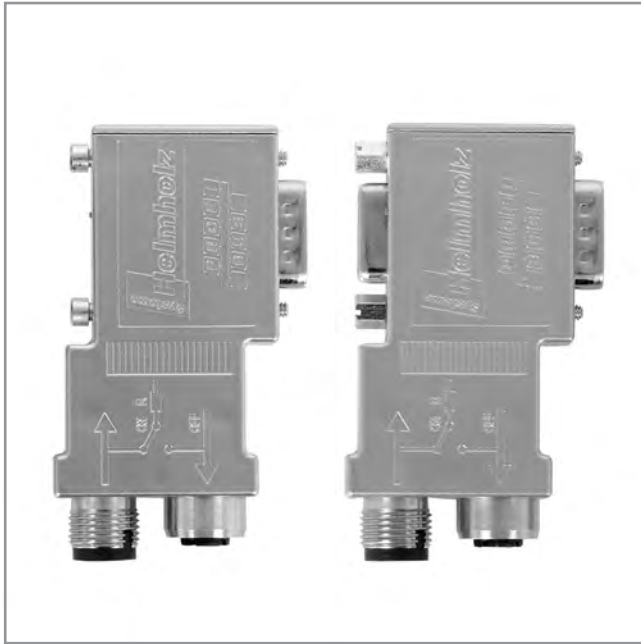

PROFIBUS connector, 90° M12

The PROFIBUS M12 plug is used to connect PROFIBUS participants to a PROFIBUS cable with M12 connector. Through the use of pre-assembled system cables, connection errors are excluded. Installation costs are reduced to a minimum. The connector has two M12 connections and integrated terminating resistors. For improved electromagnetic compatibility, the housing is metalized. The PROFIBUS connectors also work in the extended ambient temperature range of -25 °C to +85 °C¹.

FEATURES

- Metalized housing
- No parts that can be lost
- Integrated switchable terminating resistor
- 90° cable outlet
- M12 connectors



ORDERING DATA

PROFIBUS connector, 90° M12
without PG socket
with PG socket

ORDER NO.

700-974-0BA12
700-974-0BB12

The PROFIBUS connectors are also available in packs of 10 or 50 pieces.

TECHNICAL DATA

PG socket		Yes
Order No. 700-974-0BB12		No
Order No. 700-974-0BA12		
Dimensions in mm (D x W x H)		70 x 41 x 17
Weight		Approx. 60 g
Cable outlet		Vertical cable outlet
Terminating resistor		Resistor combination integrated and switchable using slide switch
Transfer rate	max.	12 Mbps
Interfaces		
PROFIBUS participants		SUB-D, 9-pin
Connector type		M12
Supply voltage		4.75 ... 5.25 V DC (must come from the device)
Current draw		
Order No. 700-974-0BB12	max.	12.5 mA
Order No. 700-974-0BA12	max.	12.5 mA
Pollution degree		2
Ambient temperature		-25 °C ... +85 °C ¹
Transport and storage temperature		-25 °C ... +85 °C
Relative humidity	max.	75% at +25 °C
Protection rating		IP 20

1) The maximum ambient temperature for UL is 60 °C.



PROFIBUS connector, 90° with ATEX approval

PROFIBUS connector 90° with ATEX approval is suitable for use in hazardous areas of zone 2 (explosive gas atmosphere occurs only rarely and briefly).

The bus connector is plugged directly into the PROFIBUS interface (SUB-D socket, 9-pin) of the PROFIBUS participants. The PROFIBUS cables are connected using 4-pin screw terminals. A slide switch is used to set whether the connector is to be used as a node or at the segment end. The switch can also be operated in the installed condition. The setting is clearly visible.

The plug is quickly mounted and has integrated, connectable terminating resistors.

FEATURES

- Metalized housing
- No parts that can be lost
- Integrated switchable terminating resistor
- 90° cable outlet
- ATEX approval (II 3 G Ex nA II T4)
- Proven screw terminal



ORDERING DATA

ORDER NO.

PROFIBUS connector, 90° with ATEX approval	
without PG socket, screw terminal	700-973-0BA12
with PG socket, screw terminal	700-973-0BB12
Wire stripping tool for PROFIBUS	700-972-6AA00

The PROFIBUS connectors are also available in packs of 10 or 50 pieces.

TECHNICAL DATA

PG socket		
Order No. 700-973-0BB12		Yes
Order No. 700-973-0BA12		No
Dimensions in mm (D x W x H)		64 x 40 x 17
Weight		Approx. 40 g
Cable outlet		Vertical cable outlet, suitable for FastConnect wire stripping tool
Terminating resistor		Resistor combination integrated and switchable using slide switch
Transfer rate	max.	12 Mbps
Interfaces		
PROFIBUS participants		SUB-D, 9-pin
Maximum outside diameter		8.0 mm
PROFIBUS cable		60/75 °C copper cable up to 1.0 mm ²
Connector type		4 serial terminals
Supply voltage		4.75 ... 5.25 V DC (must come from the device)
Current draw	max.	12.5 mA
Pollution degree		2
Ambient temperature		-20 °C ... +60 °C
Transport and storage temperature		-25 °C ... +85 °C
Relative humidity	max.	75% at +25 °C
Protection rating		IP 20

FLEXtra® twinRepeater, PROFIBUS repeater



FLEXtra® twinRepeater, PROFIBUS repeater

Despite its small size, the FLEXtra® twinRepeater is a full PROFIBUS repeater designed for mounting on a DIN rail. It regenerates the incoming electrical signal on a bus line and retransmits it (bit reshaping and retransmission). The signals are restored in level, slope, and duty cycle. The FLEXtra® twinRepeater supports data rates of 9.6 kbps to 12 Mbps and recognizes them automatically. It can be used for bus extension (up to 1 km with 2 FLEXtra® twinRepeaters), to increase the number of participants, and to expand the system. At the same time, use in MPI networks is possible. As a special application option, the FLEXtra® twinRepeater allows the setup of stubs as separate segments. The status LEDs integrated for each segment provide a quick overview of the current bus status. Furthermore, the FLEXtra® twinRepeater provides electrical isolation between the two PROFIBUS segments. In addition, it has a switch to turn off the repeating function. The segments are separated but continue to function for themselves. For connection to the PROFIBUS cable, PROFIBUS connectors are required (also available in a set).

FEATURES

- Can be used for bus extension or as a stub
- Increase the number of participants
- System expansion
- Can also be used in MPI networks
- Status LEDs for each segment
- Repeating function can be switched off
- Electrical isolation



TRANSITION RATE	MAX. SEGMENT LENGTH
9.6 kbps	1000 m
19.2 kbps	1000 m
45.45 kbps	1000 m
93.75 kbps	1000 m
187.5 kbps	1000 m
500 kbps	400 m
1.5 Mbps	200 m
3 Mbps	100 m
6 Mbps	100 m
12 Mbps	100 m

ORDERING DATA

FLEXtra® twinRepeater, PROFIBUS repeater
(incl. manual)

FLEXtra® twinRepeater set
FLEXtra® twinRepeater, 2 PROFIBUS connector 90° screw terminal with PG
(incl. manual)

ORDER NO.

700-972-2AA02

700-972-2XA02

TECHNICAL DATA

Dimensions in mm (D x W x H)	35 x 51 x 72	
Weight	Approx. 110 g	
Supply voltage	18 ... 30 VDC	
Output voltage	5 V	
Electrical isolation	500 V	
Current draw	max.	60 mA
Segment connection	Via PROFIBUS connector	
PROFIBUS interface		
Transfer rate	max.	12 Mbps Autom. detection
Protocol	PROFIBUS-DP as per EN 61 158-2	
Ambient temperature	0 °C ... +60 °C	
Transport and storage temperature	-25 °C ... +75 °C	
Protection rating	IP 20	

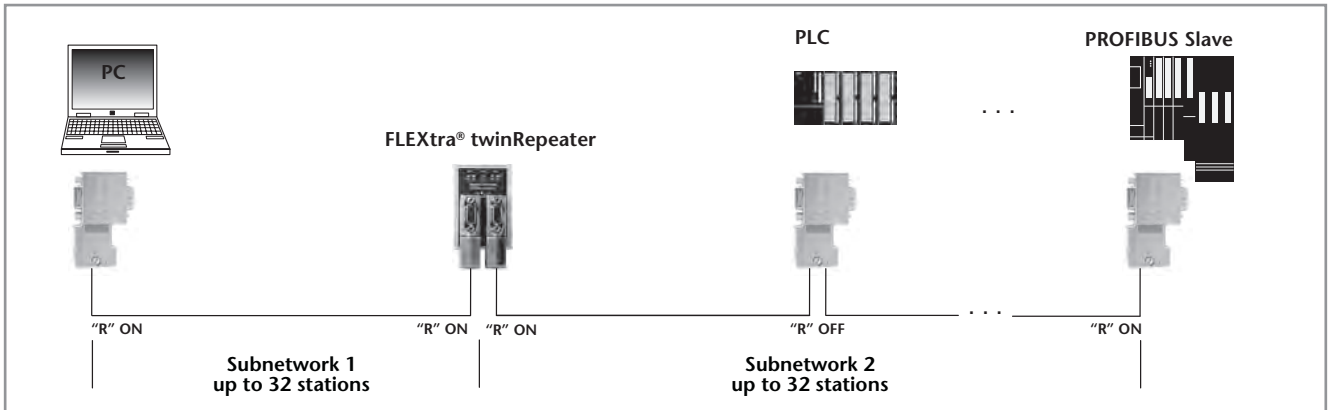

Application example of FLEXtra[®] twinRepeater with more than 32 participants

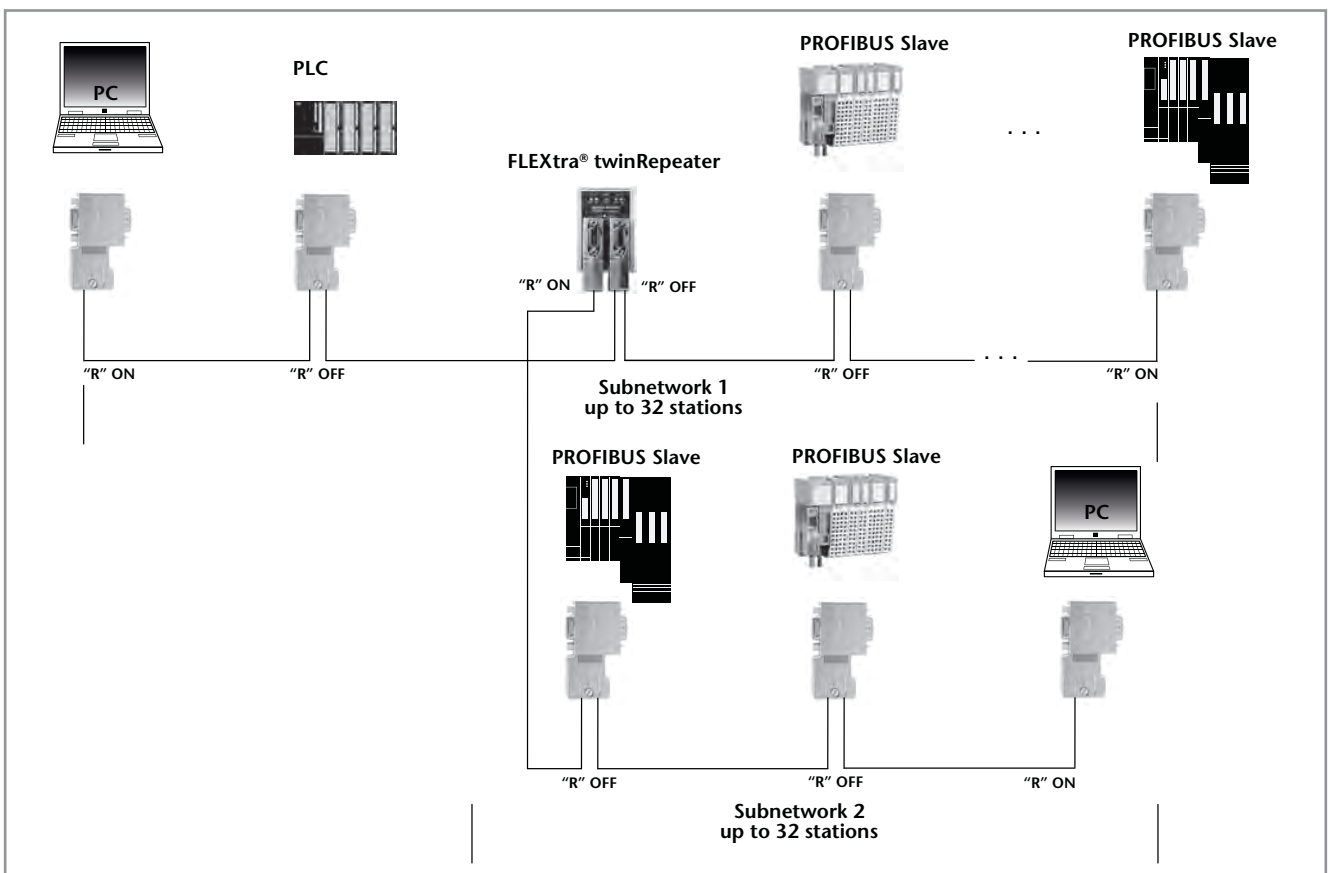

Application example FLEXtra[®] twinRepeater stub

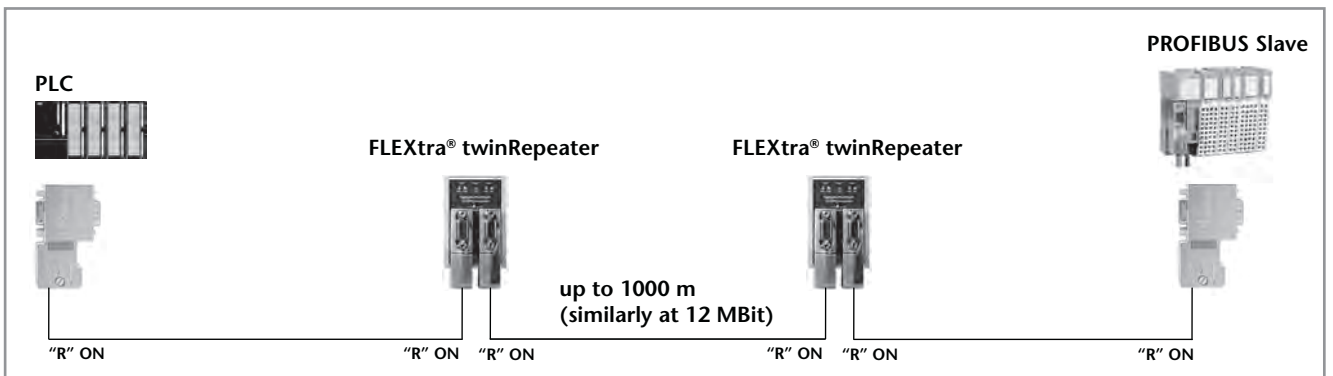

Application example FLEXtra[®] twinRepeater long distance

FLEXtra® multiRepeater 4-way/6-way, PROFIBUS repeater



FLEXtra® multiRepeater 4-way/6-way, PROFIBUS repeater

The FLEXtra® multiRepeater is a multi-PROFIBUS repeater designed for mounting on a DIN rail. It regenerates the incoming electrical signal on a bus line and retransmits it (bit reshaping and retransmission). The signals are restored in level, slope, and duty cycle. The multiRepeater supports data rates of 9.6 kbps to 12 Mbps and recognizes them automatically. It can be used for bus extension, to increase the number of participants, and to expand the system. At the same time, use in MPI networks is possible. As a special application option, the multiRepeater allows the setup of a star network with independent segments. The status LEDs integrated for each segment provide a quick overview of the current bus status. Furthermore, the FLEXtra® multiRepeater provides electrical isolation between the PROFIBUS segments. In addition, it has a DIP switch for switching off the individual segments and a switch for turning off all segments. The segments are separated but continue to function for themselves. For connection to the PROFIBUS cable, PROFIBUS connectors are required.

FEATURES

- Setup of star networks
- System expansion by up to six segments with one device
- Increase the number of participants
- Can be used for bus extension or as a stub
- Can also be used in MPI networks
- Status LEDs for each segment
- Repeating function for each segment or totally disabled
- Electrical isolation of all segments



TRANSITION RATE	MAX. SEGMENT LENGTH
9.6 kbps	1000 m
19.2 kbps	1000 m
45.45 kbps	1000 m
93.75 kbps	1000 m
187.5 kbps	1000 m
500 kbps	400 m
1.5 Mbps	200 m
3 Mbps	100 m
6 Mbps	100 m
12 Mbps	100 m

TECHNICAL DATA	4-WAY	6-WAY
Dimensions in mm (D x W x H)	35 x 94 x 72	35 x 137 x 72
Weight	Approx. 180 g	Approx. 275 g
Supply voltage	18 ... 30 VDC	18 ... 30 VDC
Output voltage	5 V, 150 mA per segment	5 V, 150 mA per segment
Electrical isolation	500 V	500 V
Current draw max.	280 mA	400 mA
Segment connection	Via PROFIBUS connector	Via PROFIBUS connector
PROFIBUS interface		
Transfer rate max.	12 Mbps Autom. detection	12 Mbps Autom. detection
Protocol	PROFIBUS-DP as per EN 61 158-2	PROFIBUS-DP as per EN 61 158-2
Ambient temperature	0 °C ... +60 °C	0 °C ... +60 °C
Transport and storage temperature	-25 °C ... +75 °C	-25 °C ... +75 °C
Protection rating	IP 20	IP 20

ORDERING DATA

	ORDER NO.
FLEXtra® multiRepeater 4-way, PROFIBUS-Repeater (incl. manual)	700-972-4AA02
FLEXtra® multiRepeater 6-way, PROFIBUS Repeater (incl. manual)	700-972-6AA02

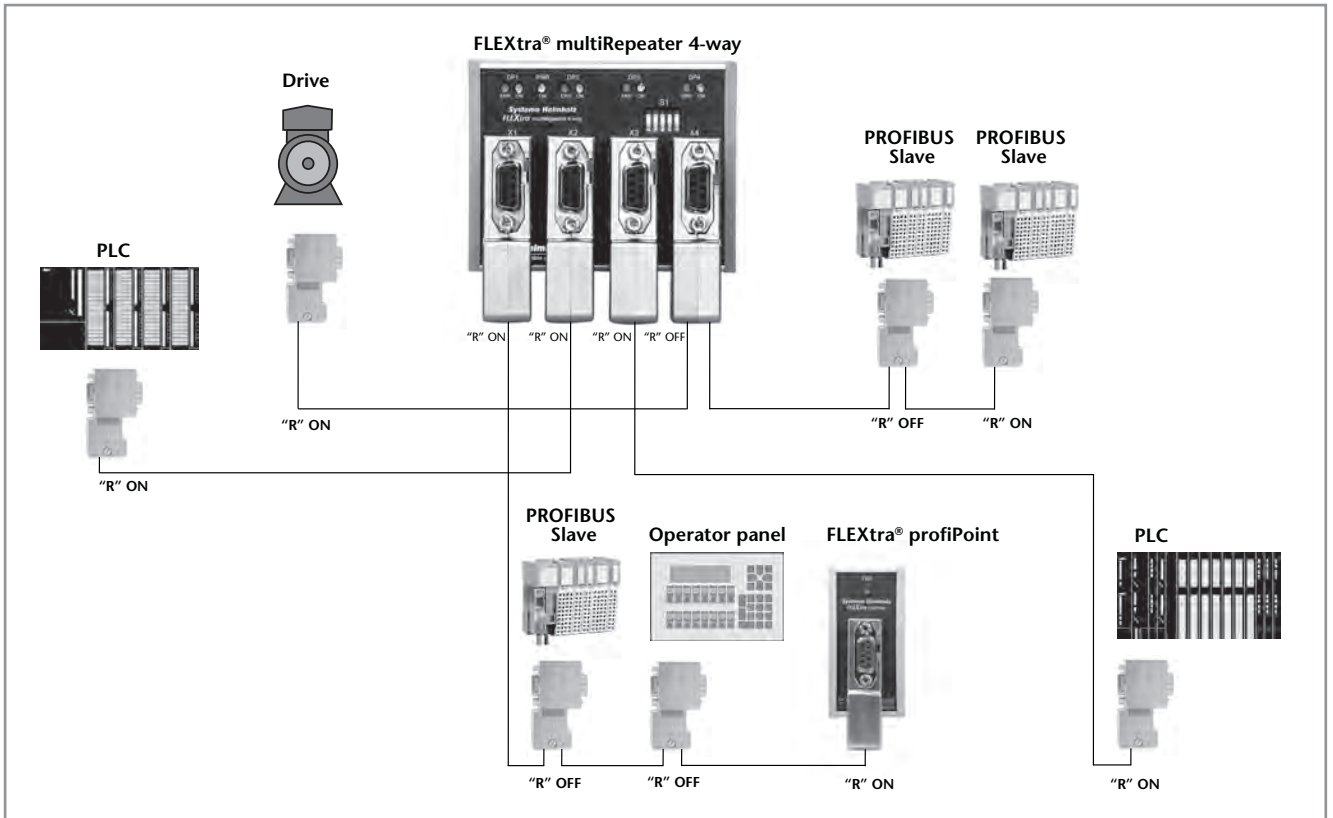

Application example FLEXtra® multiRepeater 4-way

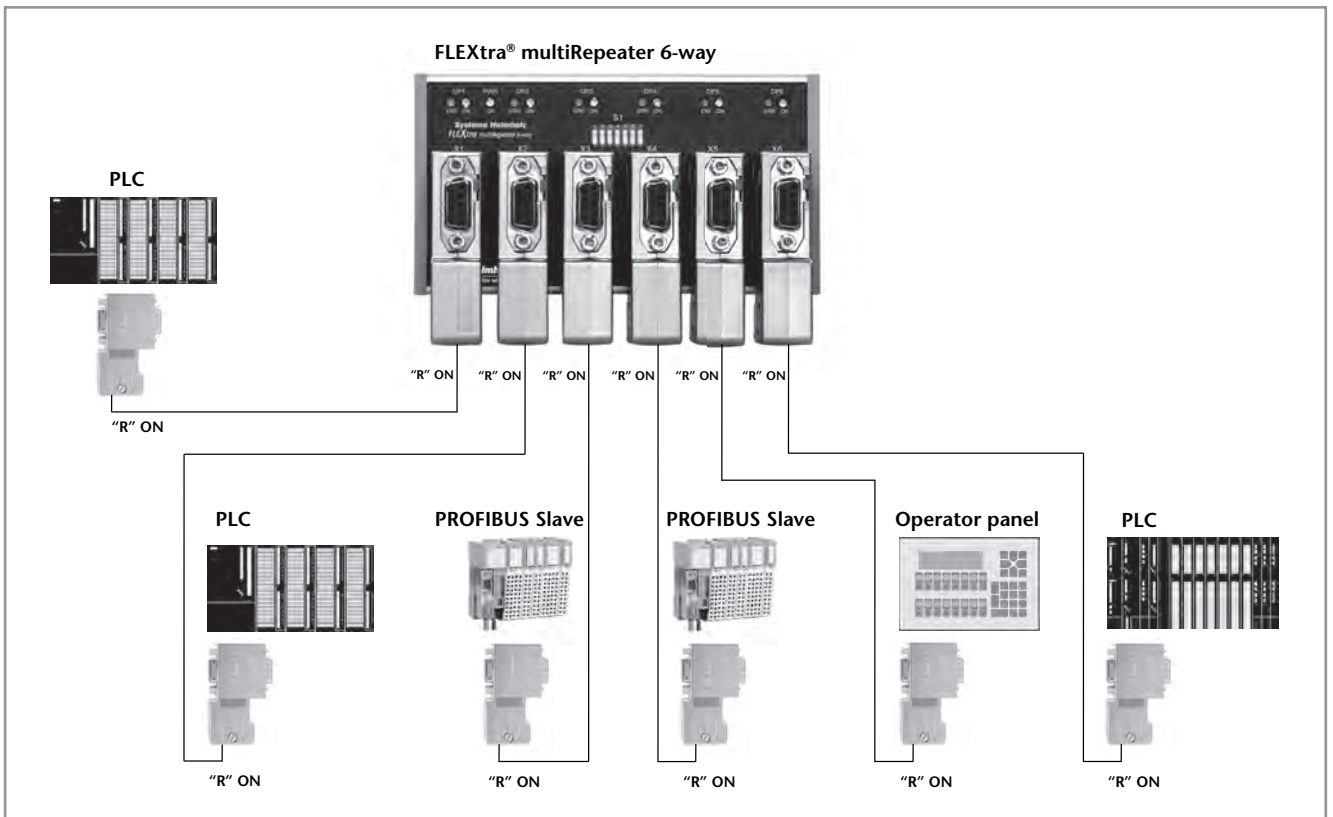

Application example FLEXtra® multiRepeater 6-way

PROFIBUS compact repeater



PROFIBUS compact repeater

The patented PROFIBUS compact repeater is a full PROFIBUS repeater that is versatile due to its very small size. It enables transfer rates of 9.6 kbps to 12 Mbps.

The transmission signals are regenerated by the repeater and re-sent (bit-resaping and retransmission) so that faults in the line are largely eliminated.

The PROFIBUS compact repeater is a great alternative to conventional repeaters for a large number of applications, both technically and in terms of price. It can be used for bus extension (up to 1 km with 2 PROFIBUS compact repeaters), to increase the number of participants, and to expand the system. Use in MPI networks is also possible. As a special application option, the PROFIBUS compact repeater allows the setup of stubs as separate segments. For this it can be plugged directly into the PG connection of an existing PROFIBUS connector.

Due to the compact design, no additional space is needed in the control cabinet, as the PROFIBUS compact repeater can be used instead of a PROFIBUS connector and is simply plugged into a participant on the PROFIBUS network. Furthermore, no separate power supply is required, because the PROFIBUS compact repeater uses the 5 V power supply, which every PROFIBUS device makes available for the terminating resistor. The PROFIBUS compact repeater establishes a potential separation between the two PROFIBUS segments.

The integrated status LEDs provide a quick overview on the current bus status.

FEATURES

- Alternative to conventional PROFIBUS repeaters
- No additional space required in the control cabinet
- Can be used for bus extension or as a stub
- Increase the number of participants
- System expansion
- Can also be used in MPI networks
- Status LEDs
- No 24 V supply required
- 5 V power supply directly from the PROFIBUS connection, making it usable on every PROFIBUS device
- Electrical isolation



TRANSITION RATE	MAX. SEGMENT LENGTH
9.6 kbps	1000 m
19.2 kbps	1000 m
45.45 kbps	1000 m
93.75 kbps	1000 m
187.5 kbps	1000 m
500 kbps	400 m
1.5 Mbps	200 m
3 Mbps	100 m
6 Mbps	100 m
12 Mbps	100 m

TECHNICAL DATA

Dimensions in mm (D x W x H)	64 x 40 x 17
Weight	Approx. 40 g
Power supply	
Voltage	+ 5 V DC
Current draw	typ. 100 mA
Socket	SUB-D 9-pin
PROFIBUS interface	
Transfer rate	max. 9.6 kbps to 12 Mbps Autom. detection
Protocol	PROFIBUS-DP as per EN 50 170
Connector	Socket, SUB-D, 9-pin
Maximum outside diameter	8.0 mm
PROFIBUS cable	60/70 °C copper cable up to 1.0 mm ²
Connector type	4 serial terminals
Pollution degree	2
Ambient temperature	-25 °C ... +85 °C ¹
Transport and storage temperature	-25 °C ... +85 °C
Protection rating	IP 20

1) The maximum ambient temperature for UL is 60 °C.

ORDERING DATA

ORDER NO.

PROFIBUS compact repeater with PG socket, screw terminal (incl. manual)	700-972-0RB12
Wire stripping tool for PROFIBUS	700-972-6AA00

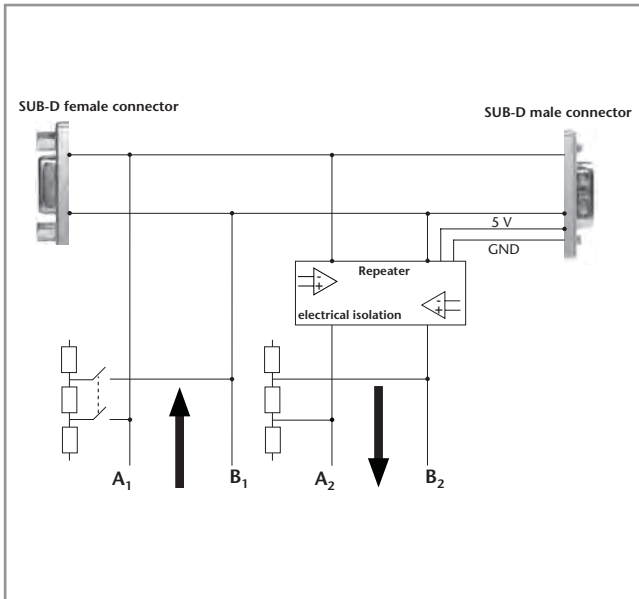

Internal design

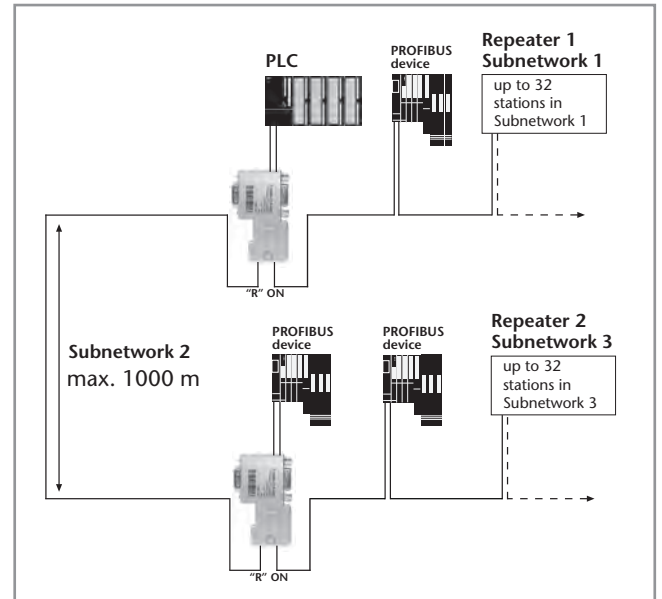

Application example long distance

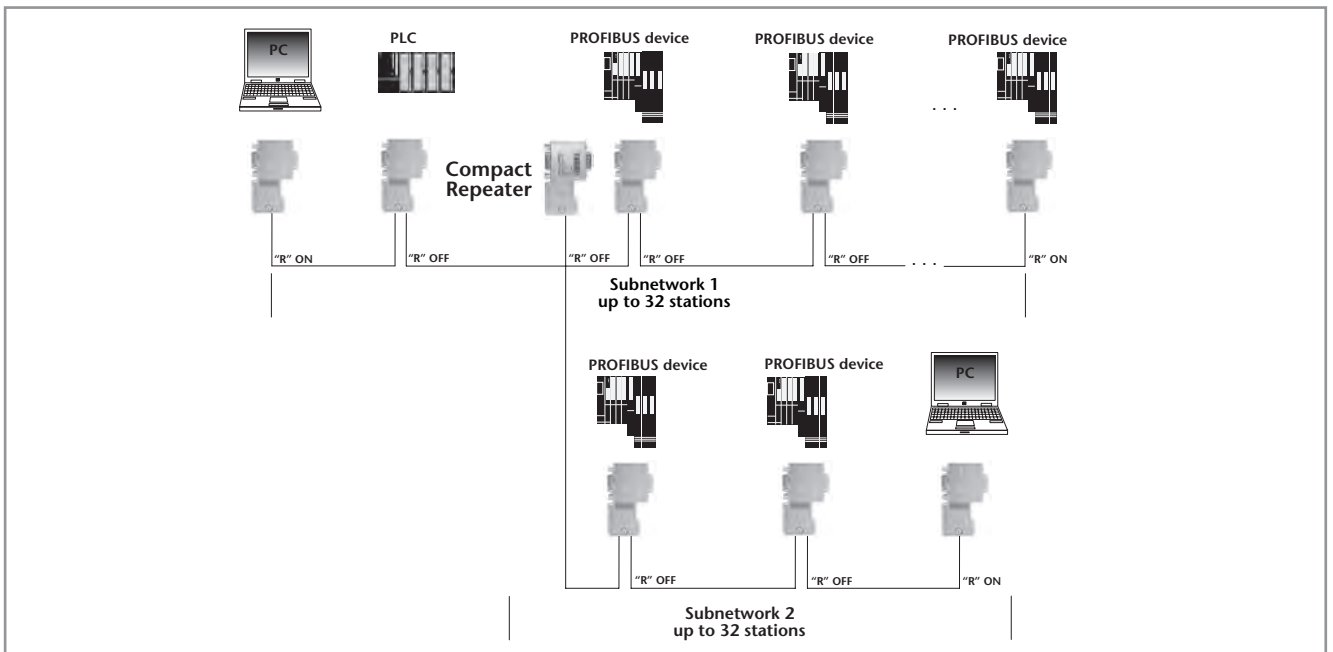

Application example stub

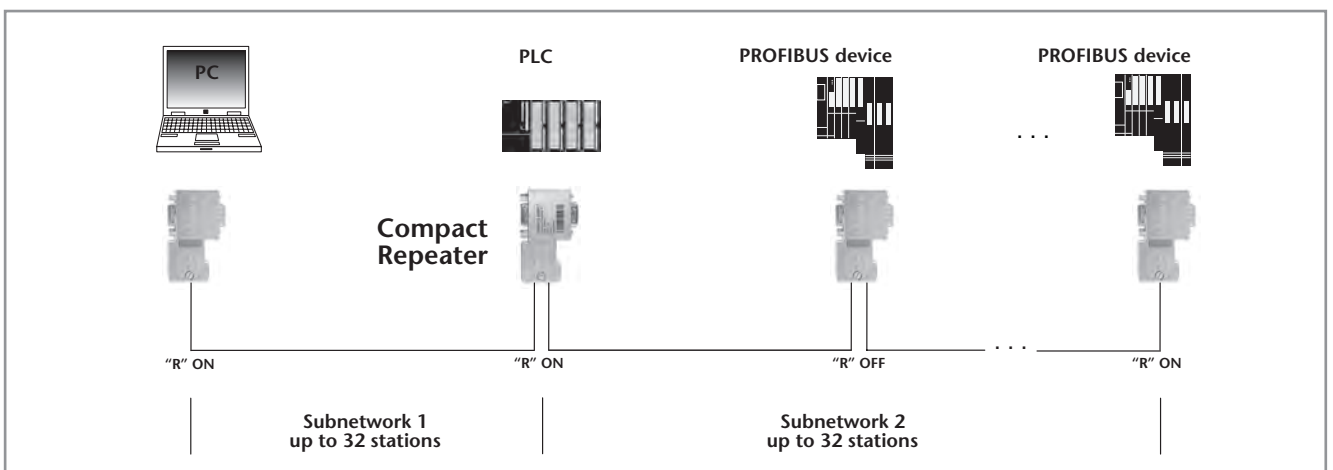

Application example of more than 32 participants



OPTopus, PROFIBUS optical link

The OPTopus PROFIBUS optical link is a full PROFIBUS repeater with integrated FO interface. It enables PROFIBUS transmission rates from 9.6 kbps to 12 Mbps with automatic baud rate detection. Due to the optical signal transmission, it offers complete electrical isolation between the PROFIBUS participants and PROFIBUS subnets. Another advantage of OPTopus is the insensitivity to EMC influences.

Due to the compact design, no additional space is needed in the control cabinet, as it can be used instead of a PROFIBUS connector and is simply plugged into a participant on the PROFIBUS network.

Furthermore, no separate power supply is required, because the OPTopus uses the 5 V power supply, which every PROFIBUS device makes available for the terminating resistor.

The transmission signals are converted into optical signals by the OPTopus and are transmitted on the fiber-optic link; in addition, they are also regenerated with slope, level, and duty cycle.

The OPTopus is available with 3 different optical interfaces and is therefore perfectly compatible with existing transmission systems. It is suitable for POF¹ and PCF¹ FO. For the short range up to 65 m, an optical transmission link can be established very quickly and without much effort using the POF. For this purpose, the matching connector is included with the OPTopus. All that is needed is a standard POF¹ FO. For longer distances up to 250 m, PCF¹ FO can be used.

The optical interface of the OPTopus sends in the visible range (650 nm red light), which allows an initial check of the optical transmission link without expensive instruments.

The OPTopus offers the advantages of a normal repeater, such as: Bus extension, increasing the number of participants and expanding the system. Use in MPI networks is also possible.

As a special application option, the OPTopus allows the setup of stubs as separate segments. For this it can be plugged directly into the PG connection of an existing PROFIBUS connector.

For diagnostic purposes, the OPTopus has one Traffic and one Error LED for the PROFIBUS interface, along with one of each for the optical interface. In this way you are always informed about the bus state, and targeted troubleshooting is ensured.

There is also a Power LED that provides information about the operating state and the status of the terminating resistor.

FEATURES

- PROFIBUS baud rate (9.6 kbps ... 12 Mbps) automatic detection
- Compact design, no bigger than a Helmholz PROFIBUS connector
- Display of traffic/bus errors separately for the FO and PROFIBUS segment
- Switchable terminating resistor with optical display
- Complete electrical isolation
- Insensitive to EMC influences
- No 24 V voltage supply required
- Available with 3 different optical interfaces (SMA, BFOC², Versatile Link³)
- Suitable for POF¹ and PCF¹ FO
- Range: Cable length POF¹ 65 m
Cable length PCF¹ 250 m
- POF¹ FO connectors provided

TECHNICAL DATA

Dimensions in mm (D x W x H)	Approx. 64 x 40 x 17
Weight	Approx. 40 g
Power supply	
Voltage	+ 5 V DC
Current draw	typ. 100 mA
Socket	SUB-D 9-pin
PROFIBUS interface	
Transmission rate	9.6 kbps to 12 Mbps Autom. detection
Protocol	PROFIBUS-DP as per EN 61158-2:2011-09
Connector	Socket, SUB-D, 9-pin
Optical interface	
Wavelength	650 nm
Numerical aperture of the transmitting diode	0.50
Integrable optical power / receiver sensitivity	
POF ¹ 980/1,000 µm	-7.5 dBm/-20 dBm
PCF ¹ 200/230 µm	-18 dBm/-22 dBm
Overdrive limit of the receiver	-3 dBm
Bridgeable distance	
POF ¹ 980/1,000 µm (160 dB/km)	Up to 65 m
PCF ¹ 200/230 µm (10 dB/km)	Up to 250 m
Ambient temperature	0 °C ... +60 °C
Transport and storage temperature	-25 °C ... +75 °C
Protection rating	IP 20

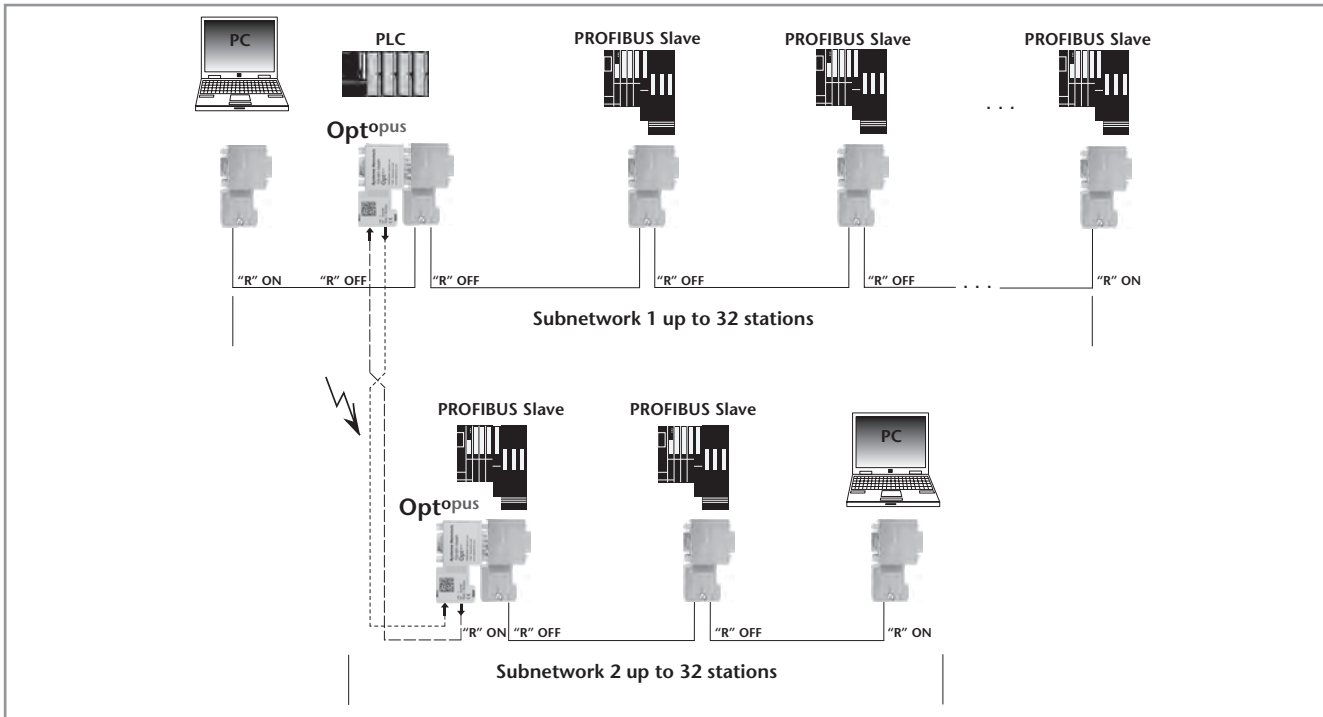

Generate a SUB network that is fully isolated electrically.

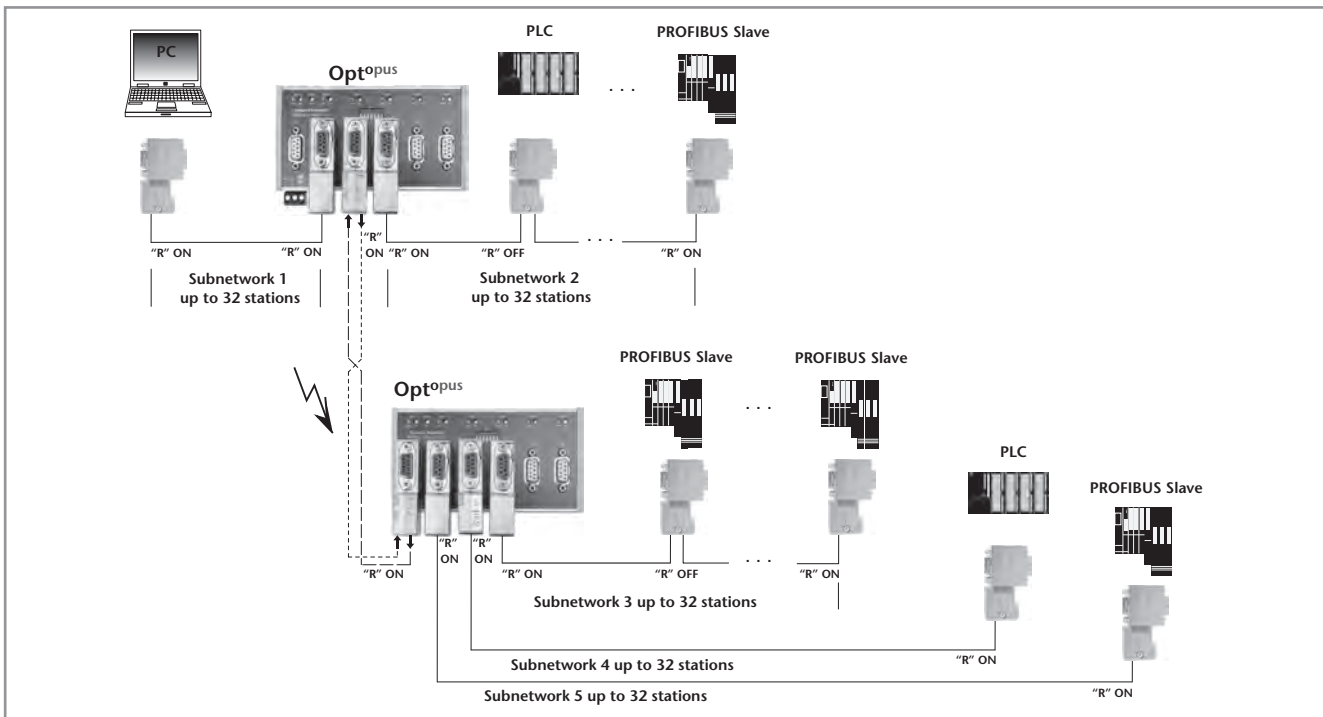

Establish a connection between two repeaters without being influenced by EMI interference.

ORDERING DATA

ORDER NO.

OPTopus, PROFIBUS optical link Versatile Link³, 650 nm, POF/PCF¹
(incl. manual, POF connector)

700-991-1AA01

OPTopus, PROFIBUS optical link BFOC², 650 nm, POF/PCF¹
(incl. manual, POF connector)

700-992-1AA01

OPTopus, PROFIBUS optical link SMA, 650 nm, POF/PCF¹
(incl. manual, POF connector)

700-993-1AA01

Note

1) PCF stands for polymer clad fiber and is synonymous with HCS. POF stands for polymeric optical fiber. For the PCF/HCS assembly, extra PCF/HCS connectors are required, along with a special assembly tool according to the required connector technology. You get the appropriate PCF/HCS connector from your fiber-optic cable supplier.

2) BFOC stands for bayonet fiber-optic connector. This type of connector is functionally compatible with ST connectors.

3) The connector type Versatile Link is functionally compatible with HP Simplex/Duplex connectors.



FLEXtra® FO, PROFIBUS optical hub

The FLEXtra® FO is a PROFIBUS repeater expanded by 2 (with the FLEXtra® FO 650-2) and 5 (with the FLEXtra® FO 650-5) optical MPI/PROFIBUS segments.

It enables conversion of electrical MPI/PROFIBUS interfaces into optical MPI/PROFIBUS interfaces.

On PROFIBUS, the FLEXtra® FO reaches transmission rates from 9.6 kbps to 12 Mbps with automatic baud rate detection. Due to the optical signal transmission, it offers complete electrical isolation between the PROFIBUS participants and PROFIBUS subnets. Another advantage of the FLEXtra® FO is its insensitivity to EMC influences. The transmission signals are converted by the FLEXtra® FO into optical signals and sent across the fiber-optic link. In addition, the signals are regenerated in slope, level, and duty cycle.

The FLEXtra® FO is perfect with existing transmission systems, since it is available with 3 different optical interfaces. It is also suitable for POF¹ and PCF¹ FO.

For the short range up to 65 m, an optical transmission link can be established very quickly and without much effort using the POF¹. For longer distances up to 250 m, PCF¹ FO can be used.

The optical interface of the FLEXtra® FO sends in the visible range (650 nm red light), which allows an initial check of the optical transmission link without expensive instruments.

The FLEXtra® FO features integrated status LEDs for each segment for diagnostic purposes. In this way you are always informed about the state of the bus and the optical interface, and targeted troubleshooting is ensured.

In addition, the FLEXtra® FO has DIP switches for turning off individual or all segments. The segments are separated but continue to function for themselves.

FEATURES

- PROFIBUS repeater with 2/5 optical MPI/PROFIBUS segments
- Perfect to combine with existing transmission systems
- PROFIBUS baud rate (9.6 kbps ... 12 Mbps) automatic detection
- Switching off of individual or all segments possible
- For use in EMC-hazardous environments
- Suitable for POF¹ and PCF¹ FO
- Available with 3 different optical interfaces (SMA, BFOC², Versatile Link³)
- Range: Cable length POF¹ 65 m
Cable length PCF¹ 250 m
- Display of traffic/bus errors for each FO and PROFIBUS segment

ORDERING DATA

ORDER NO.

FLEXtra® FO 650-2, PROFIBUS optical hub Versatile Link ³ , 650 nm, POF/PCF ¹ (incl. manual)	700-996-2CA01
FLEXtra® FO 650-2, PROFIBUS optical hub BFOC ² , 650 nm, POF/PCF ¹ (incl. manual)	700-996-2AA01
FLEXtra® FO 650-2, PROFIBUS optical hub SMA, 650 nm, POF/PCF ¹ (incl. manual)	700-996-2BA01
FLEXtra® FO 650-5, PROFIBUS optical hub Versatile Link ³ , 650 nm, POF/PCF ¹ (incl. manual)	700-996-5CA01
FLEXtra® FO 650-5, PROFIBUS optical hub BFOC ² , 650 nm, POF/PCF ¹ (incl. manual)	700-996-5AA01
FLEXtra® FO 650-5, PROFIBUS optical hub SMA, 650 nm, POF/PCF ¹ (incl. manual)	700-996-5BA01

Note

1) PCF stands for polymer clad fiber and is synonymous with HCS. POF stands for polymeric optical fiber. For the PCF/HCS assembly, extra PCF/HCS connectors are required, along with a special assembly tool according to the required connector technology. You get the appropriate PCF/HCS connector from your fiber-optic cable supplier.

2) BFOC stands for bayonet fiber-optic connector. This type of connector is functionally compatible with ST connectors.

3) The connector type Versatile Link is functionally compatible with HP Simplex/Duplex connectors.

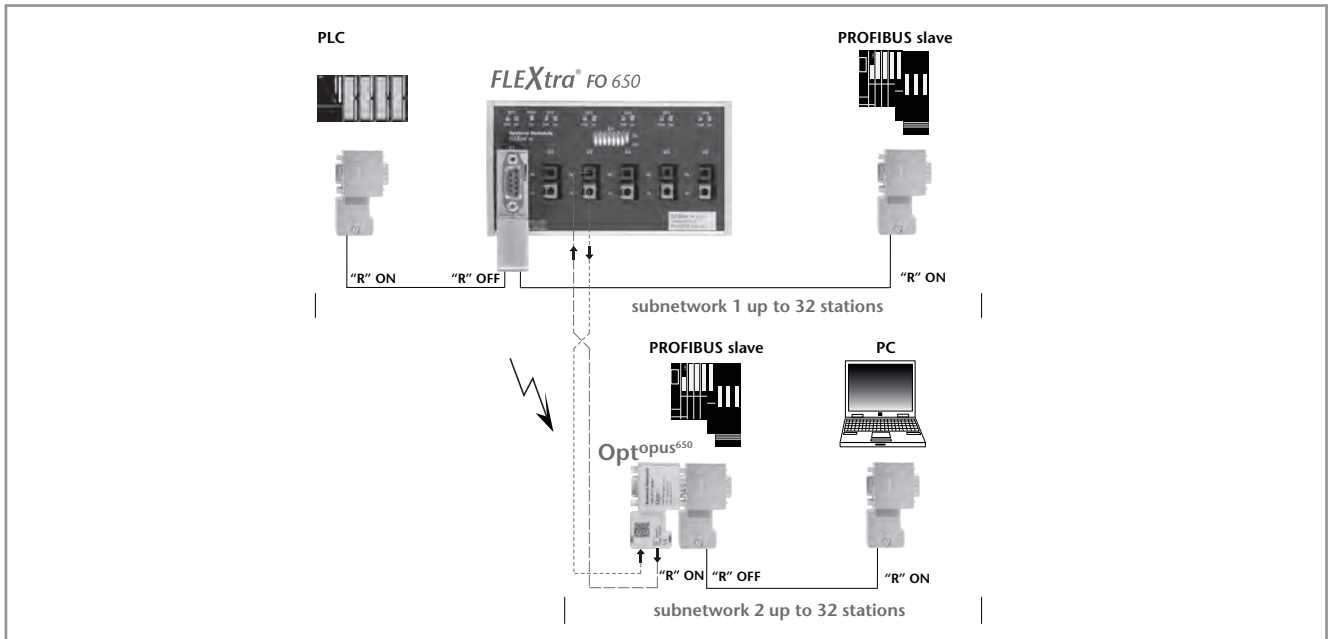

Generate a SUB network that is fully isolated electrically.

TECHNICAL DATA	650-2	650-5
Dimensions in mm (D x W x H)	35 x 70 x 72	35 x 137 x 72
Weight	Approx. 125 g	Approx. 250 g
Power supply		
Voltage	+18–30 V DC	+18–30 V DC
Electrical isolation	500 V	500 V
Current draw		
· incl. 5 V loads	Max. 200 mA	Max. 400 mA
· incl. 24 V loads	Max. 400 mA	Max. 600 mA
Output voltage port X1		
Voltage 1	5 V, max. 150 mA	5 V, max. 150 mA
Voltage 2	+18–30 V DC, max. 200 mA (as with supply voltage)	+18–30 V DC, max. 200 mA (as with supply voltage)
Electrical isolation	500 V	500 V
Current draw	max. 200 mA	400 mA
Socket		
Port 1	SUB-D 9-pin	SUB-D 9-pin
Port 2–5	BFOC ² , SMA, Versatile Link ³	BFOC ² , SMA, Versatile Link ³
PROFIBUS interface		
Transmission rate	9.6 19.2 45.45 93.75 187.5 500 kbps 1.5 3 6 and 12 Mbps automatic detection	9.6 19.2 45.45 93.75 187.5 500 kbps 1.5 3 6 and 12 Mbps automatic detection
Protocol	PROFIBUS-DP as per EN 61 158-2:2011-09	PROFIBUS-DP as per EN 61 158-2:2011-09
Optical interface		
Wavelength	650 nm	650 nm
Numerical aperture of the transmitting diode	0.50	0.50
Integrable optical power/ receiver sensitivity		
POF ¹ 980/1,000 μm	-7.5 dBm/-20 dBm	-7.5 dBm/-20 dBm
PCF ¹ 200/230 μm	-18 dBm/-22 dBm	-18 dBm/-22 dBm
Overdrive limit of the receiver	-3 dBm	-3 dBm
Bridgeable distance		
POF ¹ 980/1,000 μm (160 dB/km)	Up to 65 m	Up to 65 m
PCF ¹ 200/230 μm (10 dB/km)	Up to 250 m	Up to 250 m
Ambient temperature	0 °C ... +60 °C	0 °C ... +60 °C
Transport and storage temperature	-25 °C ... +75 °C	-25 °C ... +75 °C
Protection rating	IP 20	IP 20



viBlu, PROFIBUS wireless system

The PROFIBUS wireless system viBlu is a virtual cable that enables the connection of distributed peripherals/intelligence (such as turntables, conveyor systems, etc.) by radio.

The data transfer takes place in the unlicensed 2.4 GHz band via Bluetooth and supports PROFIBUS baud rates from 9.6 kbps to 1.5 Mbps. Depending on local conditions, transmission links up to 100 m are possible.

The use of the PROFIBUS wireless module is possible in both single-master and multi-master systems, and permits full expansion on the PROFIBUS side; PROFIBUS DP slaves are supported behind a viBlu slave

The wireless system is powered by an external voltage supply of 24 V DC. A 9-pin Sub-D socket is used for the PROFIBUS connection. A USB interface is also integrated, which is used to parameterize the wireless link.

Five LEDs on the device provide information about the operating status on PROFIBUS and the wireless side.

Through a RP-SMA socket on the device, antennas with a larger gain can optionally be connected with the wireless module for range optimization.

Outside Europe, the use of antennas with a gain over 10 dBi is permitted, so that radio relay systems with a range of up to several km should be possible, for example.

Accessories note

For antennas, see page 32.

FEATURES

- Adjustable transmission power
- Up to 3 radio slaves on a radio master
- Bluetooth in the license-free 2.4 GHz band
- Up to 1.5 Mbps PROFIBUS-DP
- Easy configuration via USB interface
- No configuration in STEP¹ 7 necessary
- Comprehensive diagnosis of the wireless interface
- Ranges up to 100 m

TECHNICAL DATA

Dimensions in mm (D x W x H)	130 x 68 x 30
Weight	Approx. 170 g
Power supply	
Voltage	DC 24 V (18 ... 30 V)
Current draw	Typ. 100 mA
PROFIBUS	
Type	RS485, isolated
Number of slaves	3
Transmission rate	9.6 kbps ... 1.5 Mbps, autom. detection
Connector type	SUB-D socket, 9-pin
Wireless interface	
Protocol	Bluetooth
Range	Up to 100 m
Baud rate	Up to 700 kbps
Antenna connection	RP-SMA socket
Ambient temperature	0 °C ... +60 °C
Displays	5 LEDs
Protection rating	IP 20

1) STEP is a registered trademark of Siemens AG.

ORDERING DATA

viBlu 200 master, PROFIBUS wireless system
2.4 GHz Bluetooth; connection of up to 3 slaves; 1.5 Mbps (incl. manual, CD with software)

ORDER NO.

700-762-PFM11

viBlu 200 slave, PROFIBUS wireless system
2.4 GHz Bluetooth (incl. manual, CD with software)

700-762-PFS11

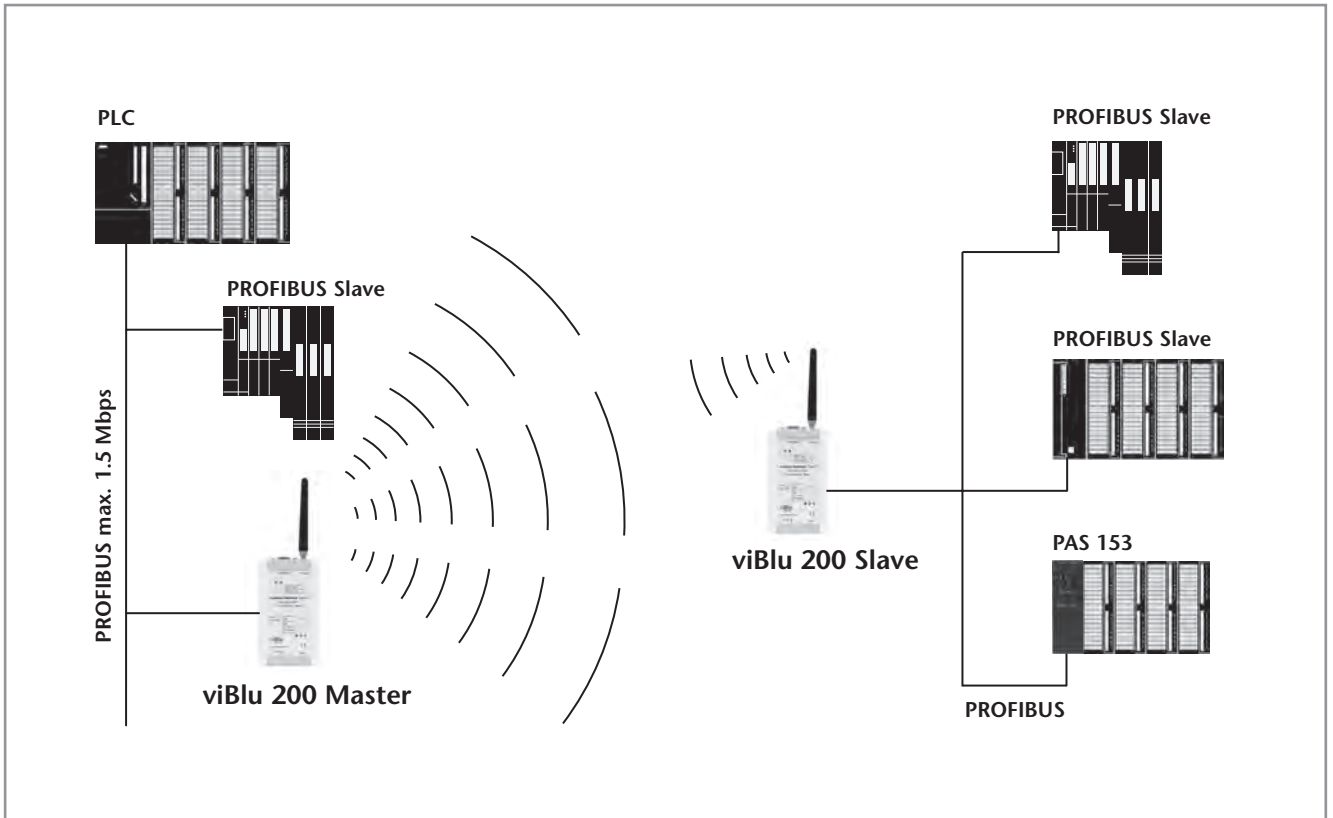

Application example viBlu 200 with a radio slave and up to three PROFIBUS-DP participants

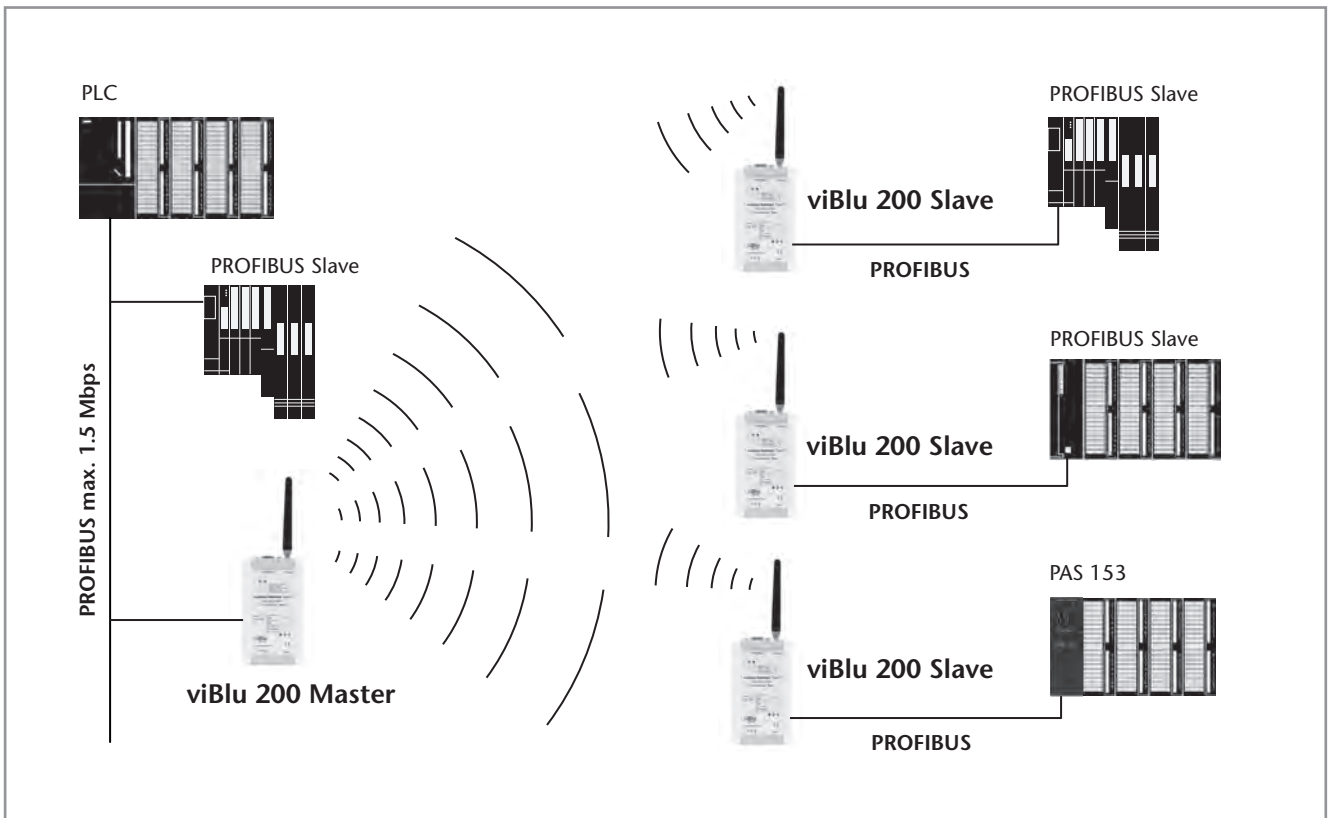

Application example viBlu 200 with 3 radio slaves

Antennas for NETLink® WLAN and viBlu



5 dBi magnetic base antenna

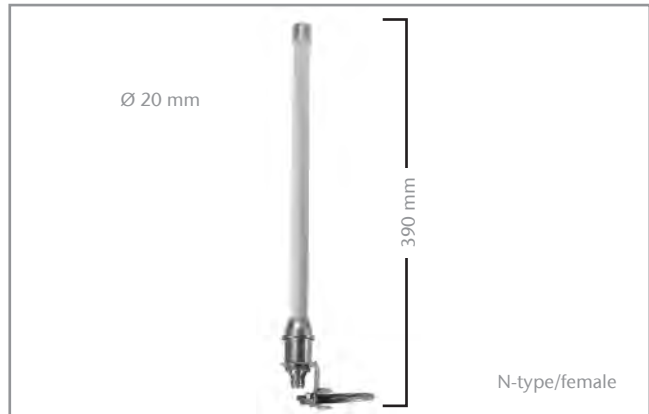

Omni 8 dBi antenna; incl. wall mount



Panel 8 dBi antenna

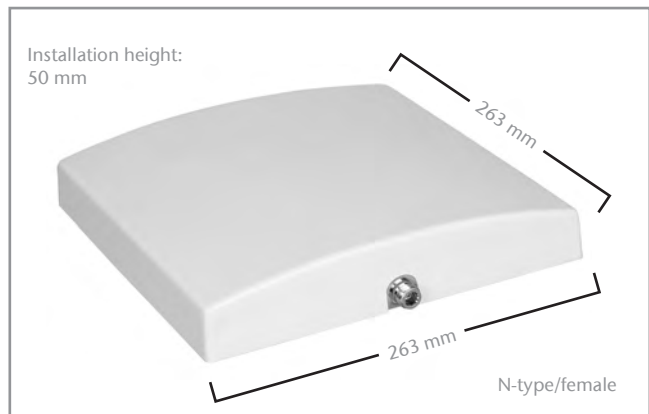

Panel 18 dBi antenna

To optimize the reception performance of the PROFIBUS wireless system viBlu and NETLink® WLAN, we offer a selection of different antennas. Depending on the antenna design, appropriate connection cables can be purchased.

When planning a wireless link, it is necessary to consider both with a mobile and stationary installation that the range may be influenced more or less by obstacles and the surrounding buildings. Due to the maximum transmission power of 100 mW in the 2.4 GHz range, wireless links of 10 to 30 meters are possible in buildings. Outdoors, 100 to 300 meters are considered realistic with line-of-sight connections.

With a directional panel antenna, wireless links exceeding 300 meters are also possible under optimum conditions.

Magnetic base antenna 5 dBi

For mounting on smooth magnetic surfaces. The action radius is increased by the permanently mounted 1.5-meter-long connecting cable. The magnetic base can be unscrewed. In this way the dipole can also be operated directly on the WLAN module, which is especially suitable for medium distances with clear line of sight. With the integrated articulated joint, the circular antenna can always be aligned correctly.

Omni-directional antenna 8 dBi

This omni-directional antenna protected by the sturdy GRP pipe is delivered with a mounting bracket for mounting it on masts or walls – preferably outdoors.

For best omni-directional characteristics, metallic surfaces and obstacles in the vicinity of the antenna should be avoided. For the N-type connector, a cable available in the accessories is required.

Panel antenna 8 dBi (wall mounting) and panel antenna 18 dBi (mast mounting)

Ideal for use in directional transmission and reception indoors and outdoors.

The range and WLAN performance is significantly improved by this design. The corresponding fixtures are included. For the N-type connector, a cable available in the accessories is required.

ORDERING DATA

ORDER NO.

Antenna for WLAN/Bluetooth 2.4 GHz magnetic base antenna, 5 dBi incl. 1.5 m cable	700-889-ANT01
Antenna for WLAN/Bluetooth 2.4 GHz Omni 8 dBi antenna, antenna cable required	700-889-ANT02
Antenna for WLAN/Bluetooth 2.4 GHz Panel 8 dBi antenna, antenna cable required	700-889-ANT03
Antenna for WLAN/Bluetooth 2.4 GHz Panel 18 dBi antenna, antenna cable required	700-889-ANT04
Antenna cable for WLAN/Bluetooth, 3 m; 2.4 GHz; 1.7 dB; Ø 5 mm	700-889-ANK01
Antenna cable for WLAN/Bluetooth, 5 m; 2.4 GHz; 2.8 dB; Ø 5 mm	700-889-ANK02
Antenna cable for WLAN/Bluetooth, 6 m; 2.4 GHz; 1.4 dB; Ø 10.3 mm	700-889-ANK03
Antenna cable for WLAN/Bluetooth, 10 m; 2.4 GHz; 2.3 dB; Ø 10.3 mm	700-889-ANK04



DP/DP coupler

FEATURES

- Exchange of up to 244 bytes of input and 244 bytes of output data between two PROFIBUS networks
- Redundant power supply
- Electrical isolation between the PROFIBUS networks
- Setting of the PROFIBUS addresses using DIP switches or software
- PROFIBUS-DP up to 12 Mbps



The DP/DP coupler interlinks two PROFIBUS DP networks together and enables data transfer between the masters of the two DP networks.

The maximum size of the transmitted data is 244 bytes of input data and 244 bytes of output data. The DP/DP coupler is configured in the S7 software or with a GSD file.

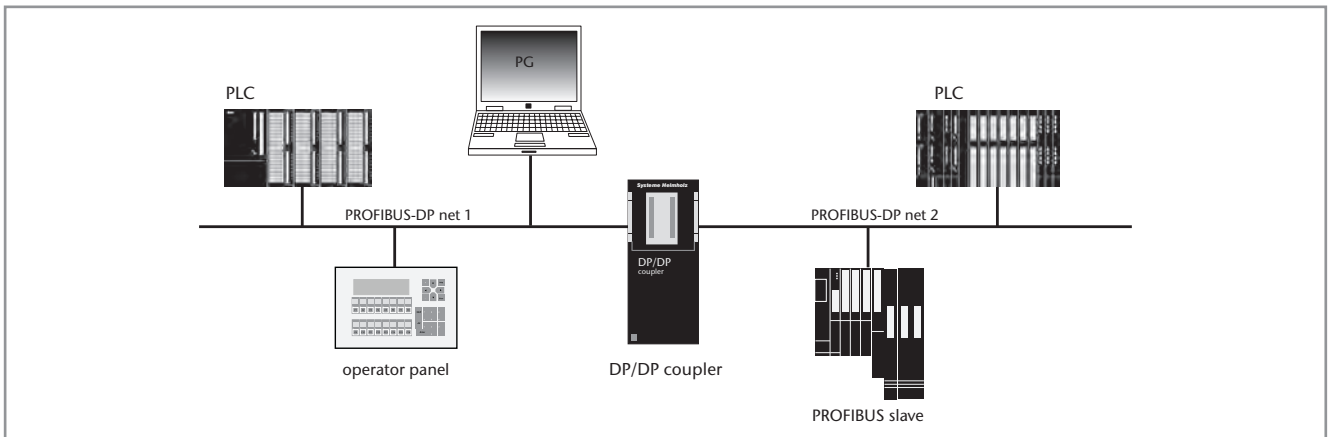

Application example DP/DP coupler

TECHNICAL DATA

Dimensions in mm (D x W x H)	116 x 40 x 125
Weight	Approx. 250 g
Power supply	
Voltage	DC 24 V (20.4 V ... 28.8 V)
Current draw	Approx. 150 mA with DC 24 V
Isolation of the 24 V power supply	
To PROFIBUS	Yes
To each other	Yes
PROFIBUS interface	
Transmission rate	9.6 ... 12 Mbps
Protocol	PROFIBUS-DP
Message length I/O data	Max. 244 bytes inputs / 244 bytes outputs
Ambient temperature	0 °C ... +60 °C
Protection rating	IP 20

ORDERING DATA

ORDER NO.

DP/DP coupler (incl. manual)	700-158-0AD02
Mounting rail adapter for DIN rail	700-390-6BA01

FLEXtra® profiPoint, active termination and measuring point



FLEXtra® profiPoint, active termination and measuring point

FEATURES

- Power supply independent of the bus participants
- Device-independent bus termination due to a separate power supply
- Suitable for use as an active measurement point
- Supply of active PROFIBUS components (compact repeater, NETLink®, PROFIBUS diagnostic connector)



The FLEXtra® profiPoint is used primarily to supply the terminating resistor and is designed for mounting on a DIN rail. It can be used in conjunction with a PROFIBUS connector as the active measurement point or as an active terminator. Power is supplied independent of the bus through a socket. Through the use of an active terminating resistor, participants of the bus system can optionally be switched on and off without causing malfunctions. An integrated LED allows the correct function of the profiPoint to be read. For connection to the PROFIBUS cable, a PROFIBUS connector is required (also available in a set).

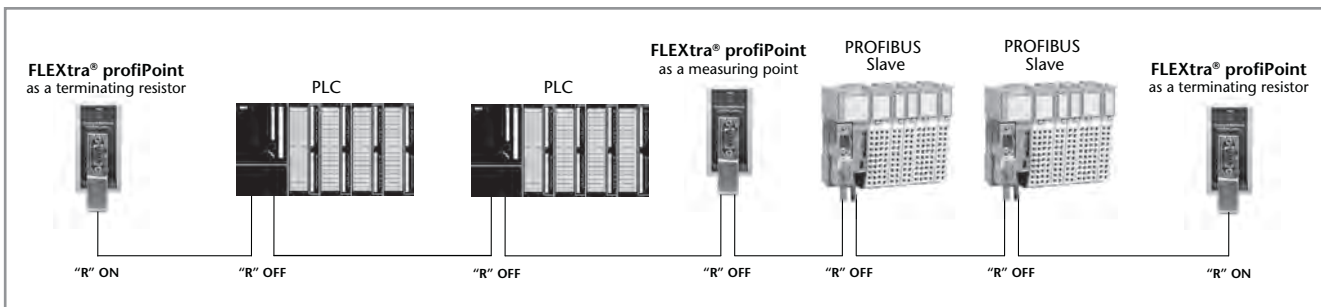

Application example FLEXtra® profiPoint

ORDERING DATA

ORDERING DATA	ORDER NO.
FLEXtra® profiPoint, active termination and measuring point (incl. manual)	700-972-1AA02
FLEXtra® profiPoint set, FLEXtra® profiPoint + 90° PROFIBUS connector, diagnosis, screw terminal with PG (incl. manual)	700-972-1XA02

TECHNICAL DATA

Dimensions in mm (D x W x H)	35 x 32 x 72
Weight	Approx. 85 g
Supply voltage	18 ... 30 VDC
Output voltage	24 VDC / 5 VDC
Electrical isolation	500 V
Current draw	max. 400 mA
Segment connection	Via PROFIBUS connector
Ambient temperature	0 °C ... +60 °C
Transport and storage temperature	-25 °C ... +75 °C
Protection rating	IP 20

Active PROFIBUS connecting cable; PROFIBUS cable, assembled



Active PROFIBUS connecting cable for PG

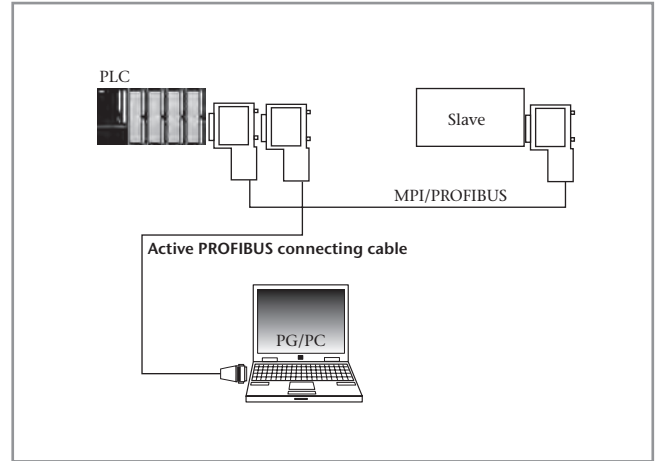

Example of active connecting cable

The active PROFIBUS connecting cable is used for easy connection of a PG to an existing PROFIBUS network. Due to the integrated electronics, it is not a stub.

TECHNICAL DATA

Dimensions in m (length)		3
Weight		Approx. 260 g
Supply voltage		DC 5 V
Current draw	max.	100 mA at 5V
PROFIBUS interface		
Transfer rate	max.	12 Mbps
Connector		SUB-D, 9-pin
Ambient temperature		0 °C ... +60 °C
Transport and storage temperature		-25 °C ... +75 °C
Protection rating		IP 20

ORDERING DATA

ORDER NO.

Active PROFIBUS connecting cable for PG with 90° PROFIBUS connector, 3 m (incl. manual)	700-901-4BD00
Active PROFIBUS connecting cable for PG with 35° PROFIBUS connector, 3 m (incl. manual)	700-901-4BD10



PROFIBUS cable assembled, 1 m

ORDERING DATA

ORDER NO.

PROFIBUS cable assembled (flexible) 2 x PROFIBUS connector 90° without PG	
1 m	700-970-1VK01
2 m	700-970-1VK02
3 m	700-970-1VK03
5 m	700-970-1VK05
10 m	700-970-1VK10
PROFIBUS cable assembled (flexible) 2 x PROFIBUS connector 90° with PG	
1 m	700-970-2VK01
2 m	700-970-2VK02
3 m	700-970-2VK03
5 m	700-970-2VK05
10 m	700-970-2VK10

This product is available on request.



PROFINET

Connectors

PROFINET Switch

PN/CAN gateway



PROFIBUS connector, RJ45, **EasyConnect**[®]

The field-assembled RJ45 connectors for PROFINET, EtherCAT, and Modbus are easy and quick to install. The industrial-grade metal housing provides the necessary ruggedness so that the plug can be used in many industrial applications.

To save the user time in wiring, the RJ45 connectors are to be assembled in one step using the quick-connect technology **EasyConnect**[®]. Solid single wires and strands can be used, and the color-coded contact elements help prevent connection errors. Currently, RJ45 industrial connectors with axial and 90°-angled cable outlets are available. With a PROFINET cable of up to 100 m length, Ethernet components such as a PROFINET station can be connected. In addition, the RJ45 connectors are designed in protection class IP20 and for transmission rates up to 100 Mbit/s.

FEATURES

- Color-coded connector contact elements help to prevent connection errors
- Transmission rates up to 100 Mbps
- No loose individual parts
- Tool-free installation
- **EasyConnect**[®] RJ45 connection (IDC) for industrial applications
- For PROFINET, Modbus and EtherCAT

ORDERING DATA

ORDER NO.

PROFINET connector, RJ45, 180°, EasyConnect [®] , 10/100 Mbps	700-901-1BB10
PROFINET connector, RJ45, 90°, EasyConnect [®] , 10/100 Mbps	700-901-1BB20

The PROFINET connectors are also available in packs of 10 pieces.

TECHNICAL DATA

Dimensions in mm (D x W x H)	
Order No. 700-901-1BB10	56.5 x 16.4 x 14.0
Order No. 700-901-1BB20	43.5 x 40.5 x 16.2
Weight	
Order No. 700-901-1BB10	Approx. 30 g
Order No. 700-901-1BB20	Approx. 35 g
Cable outlet	
Order No. 700-901-1BB10	180°
Order No. 700-901-1BB20	90°
Transfer rate	max. 100 Mbps
Interfaces	
PROFINET	RJ45
Maximum outside diameter	6.7 mm
PROFINET cable	4 x AWG 24 or AWG 22
Connector type	EasyConnect [®]
Ambient temperature	-20 °C ... +70 °C
Transport and storage temperature	-40 °C ... +80 °C
Relative humidity	max. 95 %
Protection rating	IP 20

PROFINET Switch, 4-port, managed



PROFINET Switch, 4-port, managed

With the 4-port-managed PROFINET switch, PROFINET participants can be connected saving time and costs.

With a GSDML file, you integrate the 4-port switch into your automation environment as usual. The compact and industry-compatible design for DIN rail installation convinces, as does the web interface for configuration and diagnosis. It is also possible to carry out a diagnosis and/or configuration via Telnet, SSH or USB. The supported PROFINET protocols, such as LLPD, DCP or even diagnosis alarms, can be easily configured and administered. The transmission speed of up to 100 Mbit/s, which can be defined for each port, is as much a standard feature as the PROFINET Conformance Class B and the MRP Client for transmission security through ring redundancy.

PROFINET FUNCTIONS

- Allocation of a network configuration on the basis of the device name
- Definition of the transmission process and speed of a port (auto-negotiation or fixed setting up to 100 Mbits/s full-duplex)
- Activate/deactivate port
- Set DCP/LLDP boundary for a port
- Set up PROFINET switch as MRP client
- Device exchange without programming device

FEATURES

- PROFINET Conformance Class B
- Managed Switch with 4x100 Mbps RJ45 Ports
- Integration into the automation network with GSDML file
- Quick and easy configuration and diagnosis via web interface or PROFINET
- Configuration via command lines (Telnet, SSH, USB)
- LLPD, DCP, SNMP, diagnosis alarms
- Media redundancy: MRP client via ports 1+2
- Port mirroring
- Network statistics (frames and errors)
- Time synchronization via SNTP
- Firmware updates via web server
- Compact, industry-compatible design for installation on DIN rails

ORDERING DATA

PROFINET switch, 4-port, managed
(incl. Quick Start Guide)

ORDER NO.

700-850-4PS01

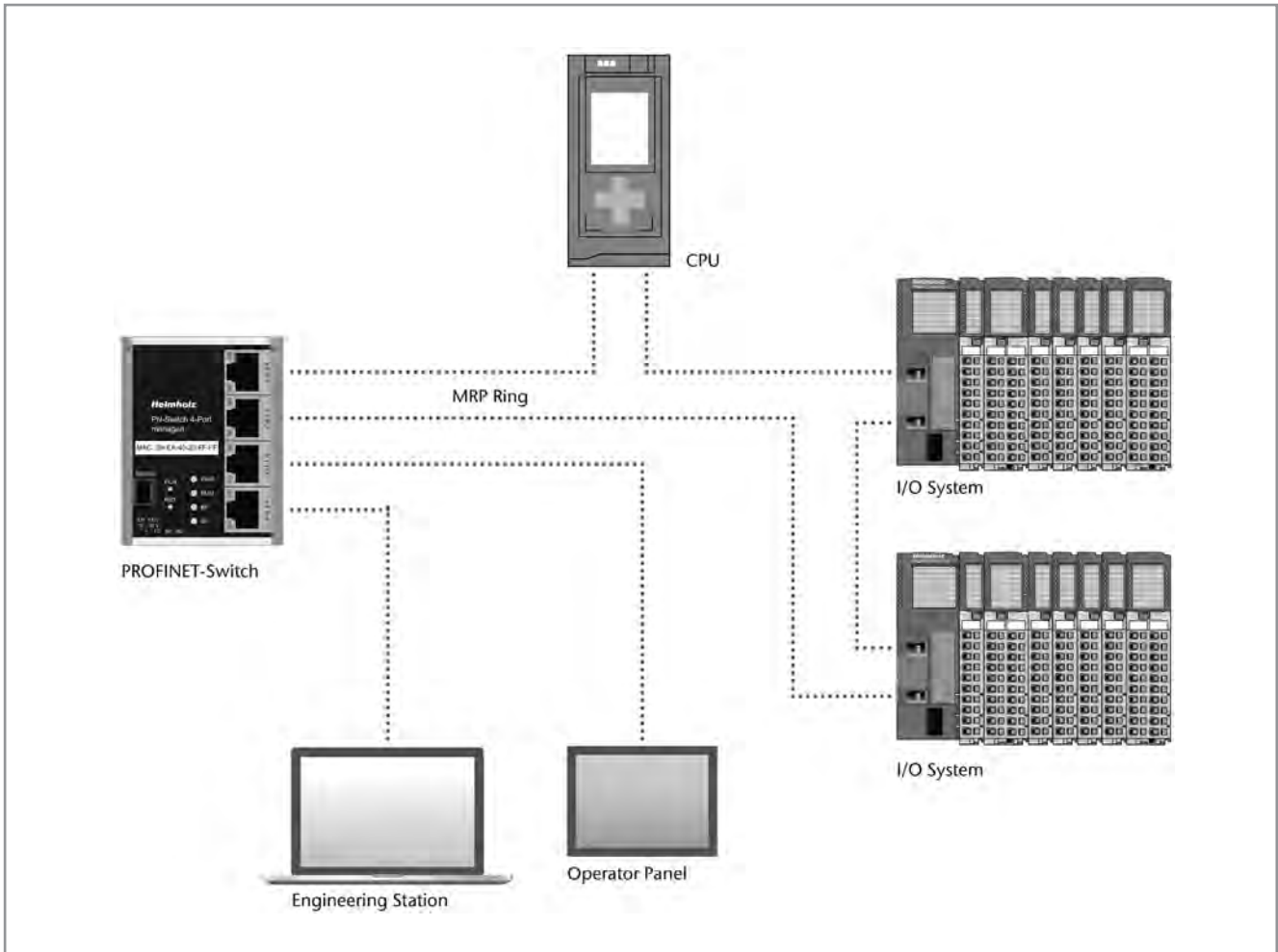

Application example for PROFINET Switch, 4-port, managed

TECHNICAL DATA

Dimensions (D x W x H)	35 x 59 x 75 mm
Weight	250 g
Number of inputs/switching point	2/DC 24 V, as per DIN EN 61131-2 Type 2
PROFINET interfaces	
· Protocol	PROFINET IO as defined in IEC 61158-6-10
· Physical layer	Ethernet
· Transmission rate	100 Mbps, full-duplex
· I/O image size	Up to 1440 bytes
· Connector	4 x RJ45, integrated switch
· Features	Conformance Class B; media redundancy (MRP); Automatic addressing/topology detection (LLDP, DCP)
USB interface	USB 2.0, mini USB
Status indicator	4 LEDs
Current draw	Max. 250 mA with DC 24 V
Ambient temperature	0 °C ... +60 °C (-20 °C ... +70 °C in development)
Transport and storage temperature	-20 °C ... +60 °C
Protection rating	IP20
Certifications	CE, GCF, FCC, PTCRB, IC



PN/CAN Gateway

The PN/CAN gateway connects CANopen® devices in a PROFINET network. At the same time, it is a full-fledged CANopen® master. As the master, it supports gateway network management, SYNC telegrams, and node guarding / heartbeat for monitoring the participants.

On the PROFINET network, the PN/CAN gateway is a PROFINET IO device that supports transfer rates up to 100 Mbps full duplex, and on the CAN bus up to 1 Mbps is supported.

The IO data (PDOs) of the CANopen® participants is transparently displayed in a freely configurable manner in the PROFINET network and can be processed directly in the PLC.

The PN/CAN gateway is integrated with a GSDML file in the hardware configurator and can be completely configured there.

Other software tools for parameterization or handling blocks for programming are not required.

Parameterization of the CANopen® participants using SDO telegrams and management of emergency messages is also possible.

Device variants with CAN Layer 2 and CANopen® Slave are in development.

FEATURES

- PROFINET IO device as per IEC 61158-6-10
- Integrated 2-port switch
- Full duplex 100 Mbps transmission rate
- Conformance class B
- Media Redundancy Protocol (MRP)
- Up to 127 CANopen® participants
- Up to 1 Mbps CAN baud rate
- Easy configuration via GSDML file, no handling blocks or parameterization software necessary
- CANopen® master and CAN layer 2 possible
- Up to 16 PDOs per CANopen® slave
- SDO communication, emergency messages, participant monitoring with heartbeat and node guarding
- Extensive diagnostic functions
- 3 two-color status LEDs
- USB interface for online diagnostics and firmware update
- DIN rail mounting

TECHNICAL DATA

Dimensions in mm (D x W x H)	35 x 83 x 72
Weight	Approx. 160 g
Power supply	
Voltage	24 V
Current draw	max. 250 mA
CAN interface	
Type	ISO/DIN 11898-2 CAN high-speed physical layer
Transmission rate	10 kbps to 1 Mbps
Protocol	CANopen® master
Connector	Connector, SUB-D, 9-pin
PROFINET interfaces	
Protocol	PROFINET IO as per IEC 61158-6-10
Physical layer	Ethernet
Transmission rate	100 Mbps, full-duplex
I/O image size	Up to 1440 bytes
Connector	2 x RJ45, integrated switch
Features	Conformance class B, Media Redundancy Protocol (MRP), automatic addressing / topology detection (LLDP, DCP)
Status indicator	3 two-color LEDs
Ambient temperature	0 °C ... +60 °C
Transport and storage temperature	-25 °C ... +75 °C
Protection rating	IP 20

ORDERING DATA

PN/CAN gateway, PROFINET/CANopen®
(incl. Quick Start Guide, CD with GSDML file
and manual)

ORDER NO.

700-670-PNC01

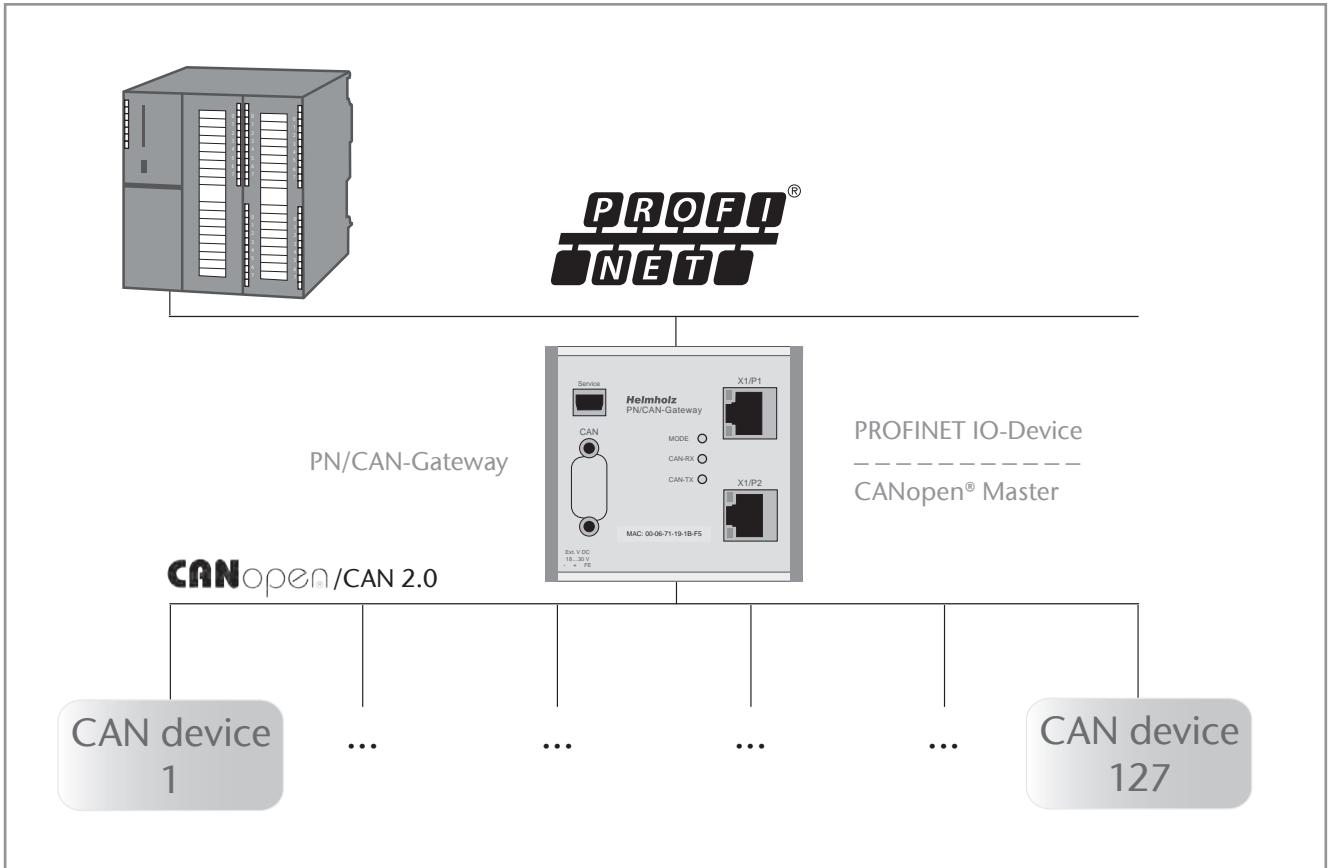

Application example for PN/CAN gateway



Remote maintenance

Ethernet routers

VPN portal

Modems

Adapters for remote maintenance

Teleservice modules



Mechanical and plant engineering

REX industrial routers enable manufacturers of machines to directly access their customers' Ethernet systems in a secure and flexible manner. In this way the technicians at the headquarters remain connected with the machines for maintenance and service in spite of world-wide deployment of the machines. The REX Global SIM can be used to implement this global connectivity easily with cost control.



Energy and environment

Wind energy is a participant in the generation of renewable energy that is more important than any other renewable energy source. But wind turbines are technically complex systems that are exposed to very high loads during operation. Regular review of their condition and maintenance of safe operation is therefore essential. However, this is difficult because wind turbines are often erected in hard-to-reach areas or in the ocean. The solution is teleservice access, which provides a flexible and reliable connection to the control center and makes constant condition monitoring possible.



Water supply/infrastructure

Networking of pumping stations or remote monitoring of water treatment plants can be implemented easily and safely with the modern industrial router system REX. In this way it is possible to monitor data and facilitate the resolution of problems in case of operational disturbances or deviations in the parameters. Likewise, it is also possible to connect distributed stations to a higher-level system.



Building automation

In modern industrial and office buildings, many activities now run automatically, such as switching on of lights and controlling the heating and ventilation system as required and on a schedule. An intelligent control system saves energy, protects the environment, and conserves resources. The industrial routers of the REX family can be used to monitor the control system at any time and take corrective action when necessary. With the Ethernet routers, it is possible to access the control system conveniently from your desktop or on a mobile basis via tablet PC or smartphone.



REX 100, Ethernet router

The REX 100 industrial routers present themselves in a compact design. Nevertheless, they offer all the features you expect from a state-of-the-art remote maintenance solution.

Regardless of the manufacturer, Ethernet participants such as PLCs can be reached with the router.

The REX 100 router is systematically designed to operate in conjunction with the VPN portal myREX24: All programming and remote maintenance is carried out on the portal. Data transmission is via encrypted VPN tunnel on the basis of the secure OpenVPN protocol.

Accessories note

Antennas for GSM, UMTS, LTE, see ordering data; additional information and technical data can be found on page 56.

FEATURES

- Integrated 3- or 4-port LAN switch
- Space-saving compact size
- WAN/LAN, 3G/LAN or LTE/LAN variants available
- Using “CTM,” download and activate the configuration directly from the VPN portal.
- Digital inputs for establishing a connection and issuing alarms
- Integrated firewall
- 3G/UMTS, LTE (Wi-Fi in development)

ORDERING DATA

ORDERING DATA	ORDER NO.
REX 100 WAN, 3 x LAN (switch)/1 x WAN interface, incl. Quick Start Guide	700-875-WAN01
REX 100 3G, 4 x LAN (switch)/1 x 3G modem (UMTS), incl. Quick Start Guide	700-875-UMT01
REX 100 LTE, 4 x LAN (switch)/1 x LTE modem, incl. Quick Start Guide	700-875-LTE01
Stationary outdoor antenna for REX 100, GSM/UMTS/LTE, 5 m cable, SMA socket	700-751-ANT31
Magnetic base antenna, indoor, for REX 100, GSM/UMTS/LTE, 3.5 m cable, SMA socket	700-751-ANT32
MiMo wall antenna for REX 100, GSM/UMTS/LTE, 2x5 m cable, SMA sockets	700-751-ANT35

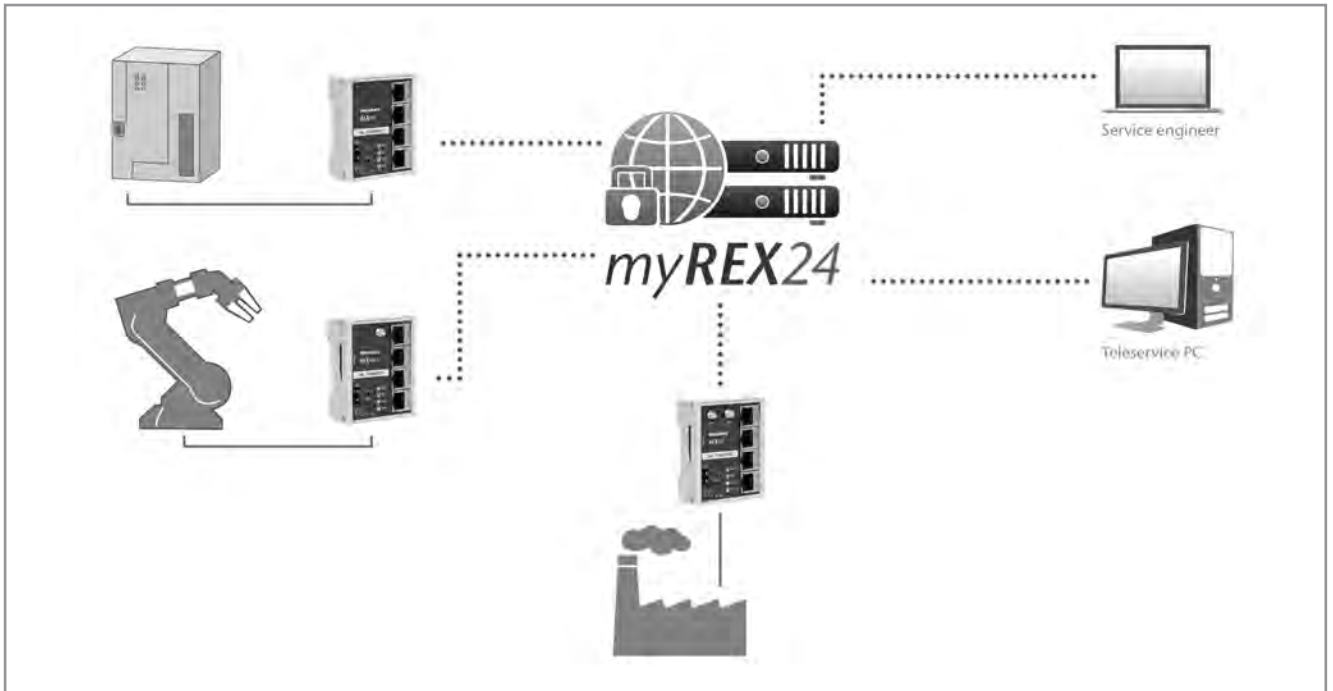

Application example for REX 100

TECHNICAL DATA	WAN	3G	LTE
Dimensions (D x W x H)	35 x 59 x 75 mm	35 x 59 x 75 mm	35 x 59 x 75 mm
Weight	250 g	270 g	270 g
Modem	—	Quad-band GPRS/EDGE data interface	LTE/HSPA/UMTS data interface
· Antenna connection	—	SMA connector (external thread)	SMA connector (external thread)
· SIM card type	—	Standard Mini-SIM, 1.8 V/3 V	Standard Mini-SIM, 1.8 V/3 V
· GSM frequency bands	—	GSM GPRS EDGE: 850, 900, 1800, 1900	GSM GPRS EDGE: 900, 1800
· UMTS frequency bands	—	UMTS HSPA+: 800/850, 900, AWS 1700, 1900, 2100	UMTS HSPA+: 850 (B5), 900 (B8), 2100 (B1)
· LTE frequency bands	—	—	LTE: 800 (B20), 1,800 (B3), 2,600 (B7)
Data transfer rates	—	HSPA+: Upload 5.76 Mbps Download 21.0 Mbps	HSPA+: Upload 5.76 Mbps Download 42.0 Mbps LTE: Upload 50 Mbps Download 100 Mbps
Number of inputs/switching point	2/DC 24 V, as per DIN EN 61131-2 Type 2	2/DC 24 V, as per DIN EN 61131-2 Type 2	2/DC 24 V, as per DIN EN 61131-2 Type 2
Routers			
· Features	Firewall, NAT/PAT, SMS wake-up	Firewall, NAT/PAT, SMS wake-up	Firewall, NAT/PAT, SMS wake-up
· VPN	OpenVPN	OpenVPN	OpenVPN
Interfaces	Three LAN 10/100 Mbps 1x WAN 10/100 Mbit/s USB 2.0 Type A port	Four 10/100 Mbps LAN ports USB 2.0 Type A port	Four 10/100 Mbps LAN ports USB 2.0 Type A port
Voltage	DC 18 V ... DC 30 V	DC 18 V ... DC 30 V	DC 18 V ... DC 30 V
Current draw	Max. 250 mA with DC 24 V	Max. 250 mA with DC 24 V	Max. 250 mA with DC 24 V
Ambient temperature	0 °C ... +55 °C (-20 °C ... +70 °C in development)	0 °C ... +55 °C (-20 °C ... +70 °C in development)	0 °C ... +55 °C (-20 °C ... +70 °C in development)
Transport and storage temperature	-20 °C ... +60 °C	-20 °C ... +60 °C	-20 °C ... +60 °C
Protection rating	IP20	IP20	IP20
Certifications	CE, GCF, FCC, PTCRB, IC	CE, GCF, FCC, PTCRB, IC	CE, GCF, FCC, PTCRB, IC



REX 300 Ethernet router

The REX 300 Ethernet routers are specially designed for use in industrial environments; they enable reliable and secure Internet teleservicing of machinery and equipment. Thanks to the integrated Firewall, remote access is allowed only for authenticated users.

An additional serial port in router versions with a WAN connection makes it possible to incorporate serial devices into your remote servicing network.

In combination with the VPN portal myREX24, you get the full service range of the industrial routers.

FEATURES

- Remote access to Ethernet-enabled devices
- Directly connect S7-MPI/PROFIBUS devices
- Service RS-232/RS-485 devices remotely via Internet
- Integrated firewall
- I/O manager for reading and archiving a maximum of 256 PLC variables
- Redundant management of multiple Internet interfaces
- S7-MPI/PROFIBUS driver included

Accessories note

Antennas for GSM/UMTS, see ordering data.

In order to connect serial devices to the REX 300 with WAN port, an adapter cable is required for the serial interface (see ordering data).

ORDERING DATA

ORDER NO.

REX 300, VPN + WAN, PROFIBUS, analog + serial interface (incl. telephone cable, Ethernet cable, Quick Start Guide)	700-872-MDM02
REX 300, VPN + WAN, PROFIBUS, UMTS + serial interface, (incl. Ethernet cable, Quick Start Guide)	700-872-UMT02
REX 300, VPN + WAN + serial interface, PROFIBUS, without modem, incl. Ethernet cable, Quick Start Guide	700-873-WAN02
REX 300 eco, VPN + WAN, without MPI port, without modem, incl. Ethernet cable and Quick Start Guide	700-874-WAN02
REX 300 eco, VPN + UMTS, without MPI interface, incl. Ethernet cable, Quick Start Guide	700-874-UMT02
Stationary quad-band antenna, GSM/UMTS, 2 dBi, 5 m cable, FME socket	700-751-ANT11
Quad-band antenna with magnetic base, GSM/UMTS, 2 dBi, 2.5 m cable, FME socket	700-751-ANT12
GSM antenna extension cable for REX 300, FME socket/plug, 5 m	700-751-ANK01
GSM antenna extension cable for REX 300, FME socket/plug, 10 m	700-751-ANK02
GSM antenna extension cable for REX 300, FME socket/plug, 15 m	700-751-ANK03
GSM antenna extension cable for REX 300, FME socket/plug, 20 m	700-751-ANK04
Serial interface (RS232) adapter cable for REX 300, 3 m, 9-pin connector	700-879-1VK11
Serial interface (RS485) adapter cable for REX 300, 3 m, 9-pin connector	700-879-1VK21
Mounting rail adapter for DIN rail	700-390-6BA01
Power adapter, 24 V, for SSW7, NETLink®, and REX 300 devices	700-751-SNT01
REX 300 Manual, German	900-87x-REX300

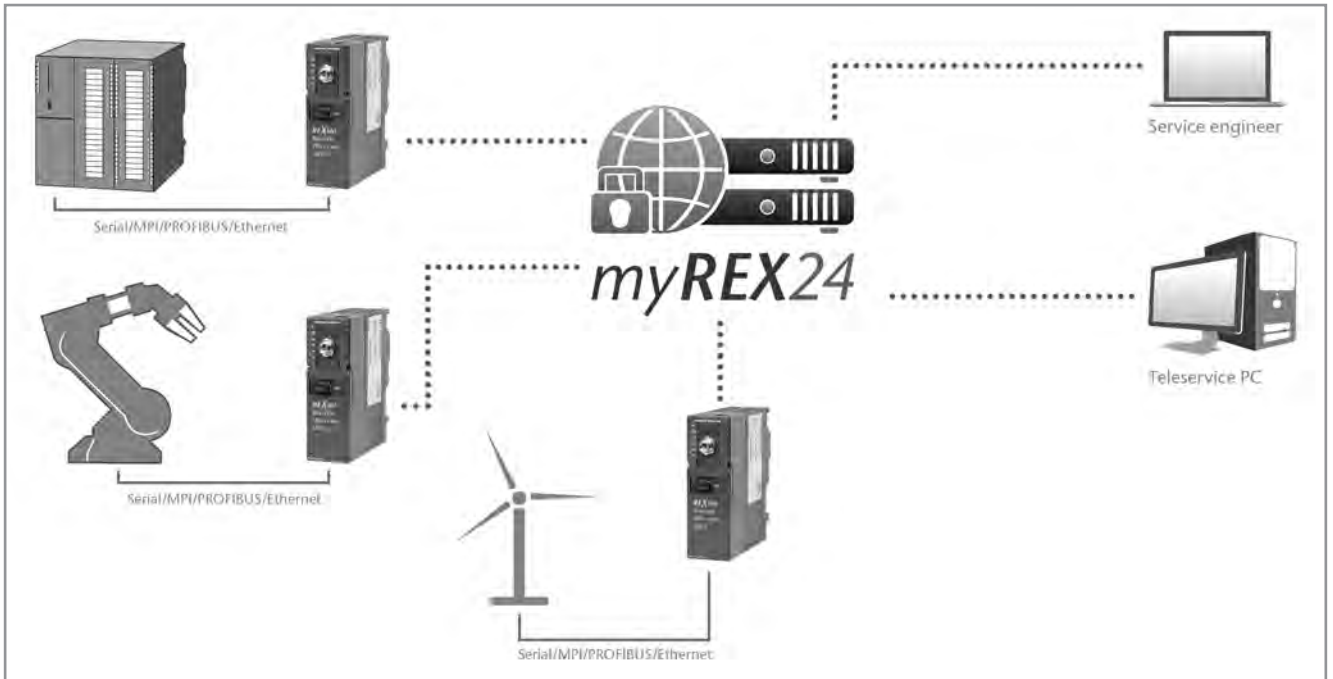

Application example for REX 300

TECHNICAL DATA

Dimensions (D x W x H)	125 x 40 x 128 mm
Weight	Approx. 300 g
GSM modem · Antenna connection · SIM card type · GSM frequency bands · UMTS frequency bands	GPRS/EDGE/UMTS/HSDPA FME connector Standard Mini-SIM, 1.8 V/3 V GSM/GPRS/EDGE: 850, 900, 1800, 1900 UMTS/HSPA: 800/850, 900, AWS 1700, 1900, 2100
Analog modem · Transmission rate · Modem port · Modem type · Transmission standards / protocols	Hayes-compatible modem Set speed of 115.2 kbps RJ-12 socket Analog interface, max. 56 kbps (V.92) V.90, V.34+, V.34, V.32bis, V.32, V.22, V.22bis, V.21, V.23
Routers · Features · VPN	DHCP server and client, firewall, DynDNS, NAT/PAT, SMS wake-up, visualization IPSec, PPTP, OpenVPN
Authentication · PPP · VPN	PAP, CHAP PSK, X.509 certificates
Encryption (VPN)	AES, DES/3DES
Interfaces	· RS-232/RS-485 (device-specific) · MPI/PROFIBUS up to 12 Mbps (device-specific) · 10/100 Mbps LAN · 10/100 Mbps WAN (device-specific) · USB 2.0 Type A port
Voltage	DC 10 V ... DC 30 V
Current draw	Max. 500 mA with DC 24 V
Ambient temperature	0 °C ... +50 °C
Transport and storage temperature	-20 °C ... +60 °C
Protection rating	IP20

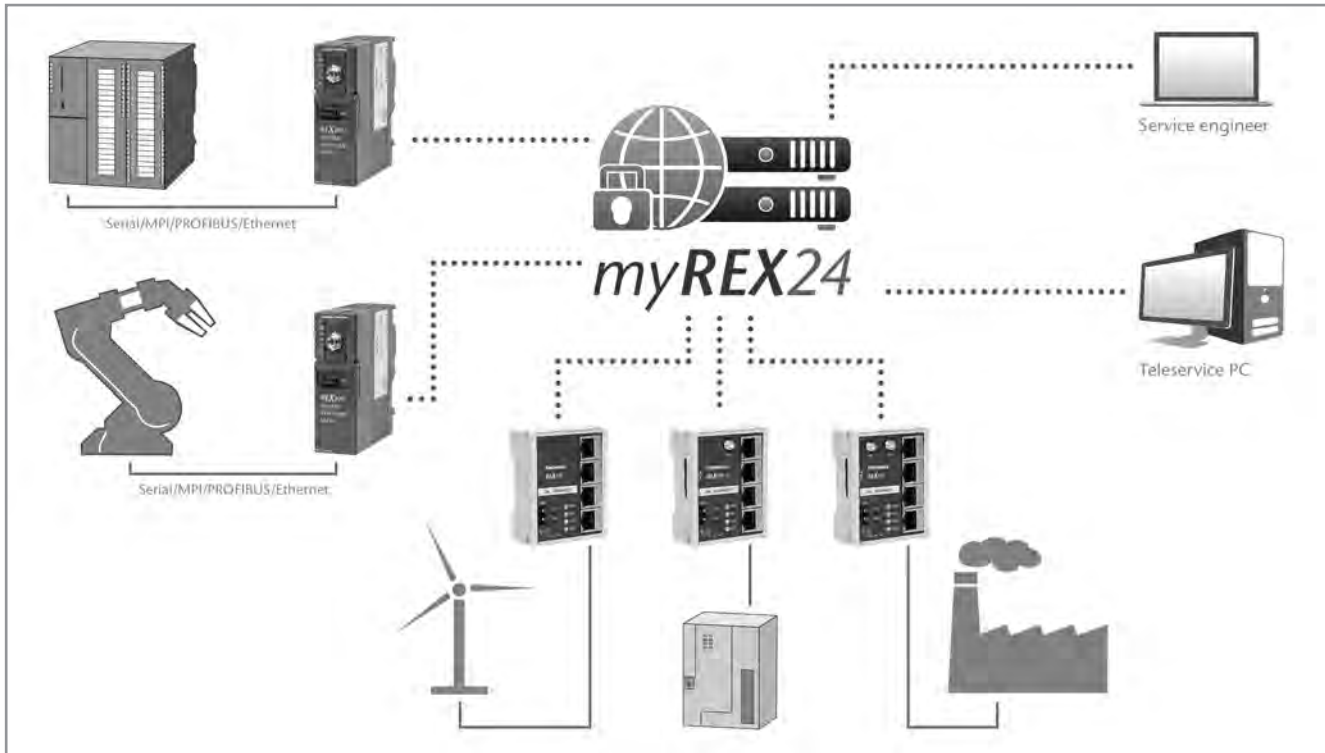

Functional principle of myREX24

myREX24, VPN portal

The VPN portal myREX24 serves as a mediation server for VPN communication between the provider of remote maintenance and the customer facility:

This means both sides can establish the VPN tunnel as an outgoing connection.

Firewalls and limitations of services or mobile operators are thus no longer an issue, because these only limit data traffic into the network and not out of the network. The outgoing connections are briefly on hold until the VPN tunnel is established, and then the actual communication takes place there.

In order to use the myREX24 system, all that is required is an Internet connection and an access account, which is set up once. The configuration of the REX routers is also created on the portal and can then be easily transferred to the router.

The myREX24 VPN portal is hosted at a high-performance data center. A redundant connection with 365/24/7 monitoring guarantees an average annual network availability of at least 99%.

YOUR ADVANTAGES

- Redundant portal hosting (>99 % availability)
- shDIALUP software for easily establishing a connection from a PC
- Configuration of the REX router on the myREX24 VPN portal
- User and permissions management system
- Reports on every single connection that is established
- myREX24 company edition – exclusive server with high reliability and its own IP address

Note

You can find additional information and ordering data on page 50.

myREX24 company edition

Do you want your own mediation server for your company?

Is your IT department demanding a closed system?

Do you need complete system performance for your own remote maintenance applications?

Do you need special functions?

Then use the “company edition” of myREX24. We host the system exclusively for you in a professional data center.

YOUR ADVANTAGES

- High reliability through exclusive redundancy
- Individual customized design
- Exclusively for your business
- A variety of performance variants

Note

You can find additional information and ordering data on page 50.



REX Global SIM

The prepaid card REX Global SIM is specially designed for teleservice and M2M applications. It is used for global connectivity of the REX industrial router to the VPN portal myREX24 – for data capture, visualization, alerting, teleservice, or direct M2M communications.

FEATURES

- Network coverage in more than 50 countries worldwide
- Two possible rate zones (Europe and worldwide)
- No contract
- Support for GSM services (3G data and SMS)
- Simple, transparent pricing with no hidden costs
- Convenient management of multiple SIM cards on the MyM2M portal



shSMS

You can use myREX24 to activate a REX GSM router with an SMS text message. The SMS text message is sent to the defined cellular network number autonomously by the myREX24 portal using shSMS.

FEATURES

- Activating connections from myREX24
- Phone number stored in the configuration
- Simple cost control
- Sending of alarm SMS messages from devices without mobile connectivity



WEB2go

WEB2go is designed to enable you to monitor your equipment even when you are on the go by allowing you to retrieve the most important equipment data on your smartphone or tablet computer.

FEATURES

- Easy access through an HTML5-enabled web browser
- HTTPS encryption
- No additional software or app needed
- Ideal for mobile remote diagnostics via smartphones or tablet computers
- Monitoring and visualization

Ordering data for REX Global SIM, myREX24

On this page you will find the ordering data for the REX Global SIM and myREX24 products.
Our technical sales is happy to help you with questions involving teleservicing.

ORDERING DATA	ORDER NO.
REX Global-SIM , mini SIM card with €15 start credit Scope of delivery: SIM card, phone number, and activation data (PIN, PUK, ICCID)	700-879-SIM01
myREX24 free Access account for myREX24.net with one free active ¹ connection and one WEB2go connection and the option of creating ten REX 300 devices for free and using ten free SMS text messages (once only). · Number of devices allowed: 250 (as of the 11th device there are additional costs) · Number of users allowed: 250 · Number of user groups/clients allowed: 250 · Number of active connections: 1 (additional charges apply starting with the 2nd active connection ¹) · Number of WEB2go connections: 1 (as of the 2nd connection there are additional costs)	
myREX24 REX01 , one-time fee for each additional REX in the portal (as of the 11th device)	800-870-REX01
myREX24 REX10 , one-time fee for 10 additional REX devices in the portal	800-870-REX10
myREX24 ac1 , license for 1 additional active connection ¹ , expires 1 year after invoice date ² .	800-870-ACT01
myREX24 ac3 , license for 3 additional active connections ¹ , expires 1 year after invoice date ² .	800-870-ACT03
myREX24 ac5 , license for 5 additional active connections ¹ , expires 1 year after invoice date ² .	800-870-ACT05
myREX24 ac10 , license for 10 additional active connections ¹ , expires 1 year after invoice date ² .	800-870-ACT10
myREX24 WEB5 , license for 5 additional WEB2go connections; expires 1 year after the invoice date ² ,	800-870-WEB05
myREX24 WEB10 , license for 10 additional WEB2go connections, expires 1 year after the invoice date ² .	800-870-WEB10
myREX24 WEB25 , license for 25 additional WEB2go connections, expires 1 year after the invoice date ² .	800-870-WEB25
myREX24 WEB50 , license for 50 additional WEB2go connections, expires 1 year after the invoice date ² .	800-870-WEB50
myREX24 shSMS 50 , package for 50 SMS	800-870-SMS05
myREX24 shSMS 100 , package for 100 SMS	800-870-SMS10
myREX24 shSMS 200 , package for 200 SMS	800-870-SMS20
myREX24 shSMS 300 , package for 300 SMS	800-870-SMS30
myREX24 shSMS 500 , package for 500 SMS	800-870-SMS50
myREX24 company edition	On request

1) Active connections
The number of active connections is the number of connections between a user and a REX device. In other words, all users and REX devices can be connected online to myREX24, but an active connection only counts the moment a user connects to a REX.

2) Term
This license will be automatically renewed for one year unless renewal is canceled at least four weeks before the license expires.



SSW7-TS, MPI adapter

The SSW7-TS can be used for remote maintenance of your system over a modem connection. To this purpose, a commercially available external modem (analog, ISDN, GSM) is connected to the RS232 interface of the SSW7-TS.

For local use, just connect the RS232 interface of the SSW7-TS to your PC. It automatically recognizes the baud rate used by the PC (9.6 to 115.2 kbaud).

On the system side, you can connect the SSW7-TS to an MPI network with 187.5 or 19.2 kbps.

On the PC, the programming software and teleservice software are required (such as teleservice for Simatic¹ STEP¹ 7) to parameterize the SSW7-TS when needed or to manage the modem connections. Without modem and teleservice software, the SSW7-TS can be used locally as a SSW7.

The SSW7->TS is supplied with voltage by the MPI bus of the CPU and can be deployed at any location in the system using an optional 24 V connection.

It is also possible to load the SSW7-TS with new firmware using a modem connection, which makes it possible to realize a functional expansion of an adapter already installed in the system. Parameterization and diagnostic functions are possible using the SHTools software.

For a firmware update, the latest SHTools version is available for free download on our website www.helmholz.com.

FEATURES

- MPI up to 187.5 kbps
- Remote maintenance via external modem (analog, ISDN, GSM)
- Can be used with Hayes-compatible modems
- Password protection
- Callback function
- Remote update capability
- Use as a programming adapter on site

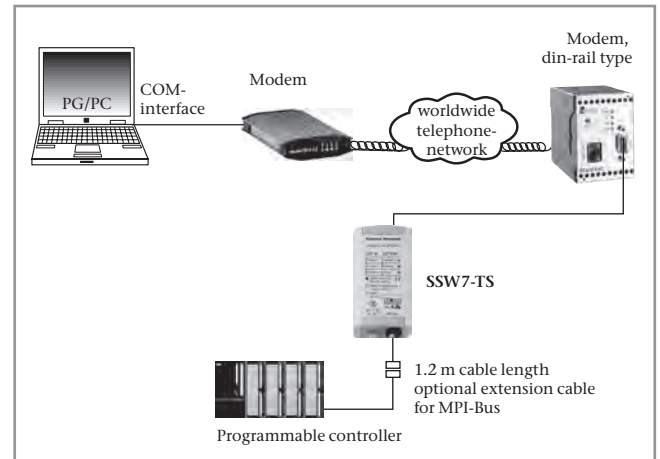

Application example for SSW7-TS

TECHNICAL DATA

Dimensions in mm (D x W x H)	105 x 53 x 29
Weight	Approx. 180 g
Supply voltage	+24 V ±25 % from AD or external
Current draw	typ. 30 mA max. 45 mA
MPI interface	
Type	RS485
Transmission rate	19.2 or 187.5 kbps
Connector	SUB-D, 9-pin; with PG interface and terminating resistor
Communication interface	
Type	RS232
Transmission type	Asynchronous serial
Transmission rate	9.6 ... 115.2 kbps
Parity	Odd
Data format	8 bits
Protocols	PC ↔ S7 via modem or local
Connector	Connector, SUB-D, 9-pin
Protection rating	IP 20

Starting with STEP¹ 7 version 5.5 SP2, Siemens no longer supports serial COM ports under Windows 7² 64 bit.

The TIA Portal¹ also no longer supports any COM ports, regardless of what operating system they are installed on!

1) STEP, Simatic, and TIA Portal are registered trademarks of Siemens AG.

2) Windows 7 is a registered trademark of Microsoft Corporation.

ORDERING DATA

SSW7-TS, MPI adapter with teleservice function (incl. manual, CD with software)

DIN rail adapter, short

Power adapter, 24 V, for SSW7, NETlink®, and REX 300 devices

ORDER NO.

700-751-8VK21

700-751-HSH01

700-751-SNT01



SSW7-TS, MPI adapter with modem; analog/GSM

The SSW7-TS with integrated modem is an economical alternative for remote maintenance of an automation device via the MPI bus.

Depending on the version, an analog or GSM modem is integrated in the housing of the SSW7-TS. The analog modem can be configured for use worldwide. All connecting cables required for operation are included. For mobile use, or if there is no telephone line, the SSW7-TS with GSM modem (quad band) is the right choice.

Using the serial interface, the SSW7-TS with modem can also be used as a PC adapter for on-site use. The respective modem can also be used for remote maintenance of a VISU/SCADA application without the TS adapter function.

The SSW7-TS with modem is powered by the CPU via the MPI cable or external voltage connection.

The SSW7-TS with modem can be provided with new firmware over a modem connection using the free software SHTools. This means a functional expansion of an adapter already installed in the system is possible. The latest SHTools version is available for download at no charge at our website www.helmholz.com.

Accessories note

For the SSW7-TS with GSM modem, you need a Mini-SIM card with activated CSD (Circuit Switched Data) service from your mobile provider and a suitable GSM antenna (for antennas, see page 56).

FEATURES

- MPI up to 187.5 kbps
- Remote maintenance and on-site use
- Password protection and callback function
- RS232 interface
- Remote update capability
- DIN rail adapter for mounting included in the delivery

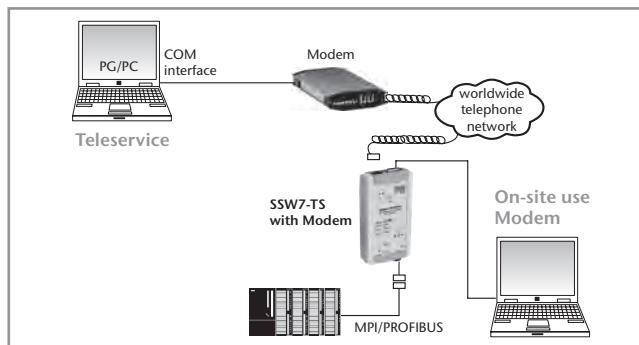

Application example for SSW7-TS with analog modem

TECHNICAL DATA

Dimensions in mm (D x W x H)	135 x 67 x 30
Weight	Approx. 240 g
Supply voltage	+24 V \pm 25 % from AD or external
Current draw	Analog approx. 100 mA, GSM approx. 150 mA
MPI interface	
Type	RS485
Transmission rate	19.2 or 187.5 kbps
Connector	SUB-D, 9-pin; with PG interface and terminating resistor
Communication interface	
Type	RS232; 2-wire dial-up line (analog)
GSM frequencies	Quad band: GSM850, EGSM900, DCS1800, PCS1900
Transmission type	Asynchronous serial
Transmission rate	9.6 ... 115.2 kbps
Protocols	PC \leftrightarrow S7 via modem or local
Connector	Connector, SUB-D, 9-pin, RJ11 or SIM card holder
Protection rating	IP 20

Starting with STEP¹ 7 version 5.5 SP2, Siemens no longer supports serial COM ports under Windows 7² 64 bit.

The TIA Portal¹ also no longer supports any COM ports, regardless of what operating system they are installed on!

1) STEP, Simatic, and TIA Portal are registered trademarks of Siemens AG.

2) Windows 7 is a registered trademark of Microsoft Corporation.

ORDERING DATA

SSW7-TS with analog modem
(incl. DIN rail adapter, 2 x telephone cable RJ11 + TAE, 3 m each, 3 m programming cable, manual, CD with software)

SSW7-TS with GSM modem
(incl. DIN rail adapter, 3 m programming cable, manual, CD with software)

Power adapter, 24 V, for SSW7, NETlink[®], and REX 300 devices

ORDER NO.

700-751-8MD21

700-751-8GS21

700-751-SNT01

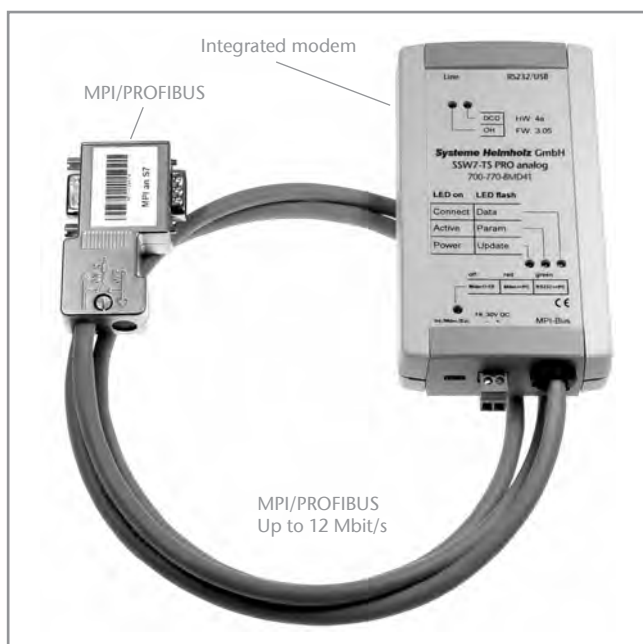

SSW7-TS PRO analog

The SSW7-TS PRO enables remote maintenance of an S7 system over a modem connection and supports connecting to an MPI or PROFIBUS network with up to 12 Mbps on the system side. Depending on the version, an analog, ISDN, or GSM modem is integrated in the housing of the SSW7-TS PRO. The analog modem can be configured for use worldwide. For mobile use, or if there is no telephone line, the SSW7-TS PRO GSM is the right choice. In addition to use as a remote maintenance solution, the SSW7-TS PRO can also be used as a PC adapter on-site with its RS232 or USB interface. Due to the integrated repeater, the MPI/PROFIBUS connecting cable of the SSW7-TS PRO is not a stub. This means the adapter can be plugged at any point along the bus even at 12 Mbps.

Power is supplied to the SSW7-TS PRO through the MPI/PROFIBUS connecting cable or on demand via the external voltage connection.

The SSW7-TS PRO allows any number of SMS text messages to be sent. Sending of the SMS is triggered by calling the function module SMS_SEND from the automation system.

Using the free software SHTools, firmware updates can be transmitted directly and via modem connection.

The latest SHTools version are available for free download from our website www.helmholz.com.

Accessories note

For the SSW7-TS PRO GSM, you need a Mini-SIM card with activated CSD (Circuit Switched Data) service and a suitable GSM antenna (for antennas, see page 56).

ORDERING DATA

	ORDER NO.
SSW7-TS PRO with analog modem (incl. DIN rail adapter, 2 x telephone cable RJ11 + TAE, 3 m each, 3 m programming cable, USB cable, manual, CD with software)	700-770-8MD41
SSW7-TS PRO with GSM modem (incl. DIN rail adapter, 3 m programming cable, USB cable, manual, CD with software)	700-770-8GS41
Power adapter, 24 V, for SSW7, NETLink®, and REX 300 devices	700-751-SNT01

FEATURES

- MPI/PROFIBUS up to 12 Mbps; Autobaud
- Remote maintenance and on-site use
- Password protection and callback function
- RS232 and USB interface
- Remote update capability
- Any number of SMS text messages can be sent from the PLC

TECHNICAL DATA

Dimensions in mm (D x W x H)	130 x 67 x 30
Weight	Approx. 240 g
Supply voltage	+24 V ±25 % from AD or external
Current draw	Approx. 130 mA
MPI/PROFIBUS interface	
Type	RS485
Transmission rate	9.6 kbps ... 12 Mbps
Connector	SUB-D, 9-pin; with PG interface and terminating resistor
Communication interfaces	
Type	RS232; 2-wire dial-up line (analog); USB
GSM frequencies	Quad band; GSM850, EGSM900, DCS1800, PCS1900
Transmission type	Asynchronous serial / USB
Transmission rate	9.6 ... 115.2 kbps
Protocols	PC <-> S7 via modem or local
Connector	Connector, SUB-D, 9-pin; RJ11; Mini-USB connector
Protection rating	IP 20

Starting with STEP¹ 7 version 5.5 SP2, Siemens no longer supports serial COM ports under Windows 7² 64 bit.

The TIA Portal¹ also no longer supports any COM ports, regardless of what operating system they are installed on!

1) STEP, Simatic, and TIA Portal are registered trademarks of Siemens AG.

2) Windows 7 is a registered trademark of Microsoft Corporation.

TS 300, teleservice module for the S7 rack



TS 300, teleservice module for the PLC rack

The TS 300 enables remote maintenance of a system via the MPI bus. It is inside a single-width S7 housing for mounting on the mounting rail. An analog modem that can be configured for worldwide use without an update is integrated into the housing of the TS 300. TAE and RJ11 cables are included in the scope of delivery. Alternatively, a variant with GSM modem is also available. The TS 300 can establish an MPI connection with the CPU via the backplane bus. Power can also be supplied through the backplane bus. This means the only thing else required for installation of a remote maintenance solution is the telephone line. The TS 300 does not need to be configured in the hardware configuration of the PLC and can be retrofitted at any time.

Alternatively, it can be supplied externally with 24 V. The MPI connection can also be established through the front-side 9-pin Sub-D socket.

An additional USB port is used to parameterize the TS 300 for on-site use as a PC adapter or for direct use of the internal modem. The TS 300 can also be provided with new firmware using a remote connection. This means a functional expansion of a TS 300 already installed in the system is also possible.

Parameterization and diagnostic functions are possible using the SHTools software.

For a firmware update, the latest SHTools version is available for free download on our website www.helmholz.com.

Accessories note

For GSM antennas, see page 56.

FEATURES

- MPI up to 187.5 kbps
- TS adapter in the S7 rack for remote maintenance
- Analog, GSM
- USB interface for parameterization or on-site use
- Password protection
- Callback function
- Remote update capability
- Alarm functions and switching outputs can be used via the backplane bus
- Operating mode switching via remote connection
- For each module, up to 2 alarm messages can be configured and sent by SMS
- Communication via backplane bus possible³

ORDERING DATA**ORDER NO.**

TS 300, teleservice module for the S7 Rack with analog modem, incl. 3 m USB cable, 2 x telephone cable (RJ11+TAE), 3 m each, manual, CD with software	700-753-8MD21
TS 300, teleservice module for the S7 rack with GSM modem, incl. 3 m USB cable, manual, CD with software	700-753-8GS21
MPI connection cable, 0.5 m	700-753-6VK11
Mounting rail adapter for DIN rail	700-390-6BA01
Mounting rail 40 mm, for module mounting	700-390-1XA04

Starting with STEP¹ 7 version 5.5 SP2, Siemens no longer supports serial COM ports under Windows 7² 64 bit.

Parameterization and remote maintenance is no longer possible with the teleservice module integrated in the TIA Portal¹.

1) S7-300, STEP, and TIA Portal are registered trademarks of Siemens AG.

2) Windows is a registered trademark of the Microsoft Corporation.

3) When using the following CPUs, the MPI functionality on the backplane bus is not recommended: S7-315 2 DP/PN, S7-317, S7-318, and S7-319 (as of: 11-2011)

TECHNICAL DATA	TS 300 ANALOG	TS 300 GSM
Protection rating	IP 20	IP 20
Dimensions (D x W x H)	116 x 40 x 124 mm	116 x 40 x 124 mm
Weight	Approx. 280 g	Approx. 280 g
Operating voltage	DC +24 V \pm 25 %, external or 5 V via backplane bus	DC +24 V \pm 25 %, external or 5 V via backplane bus
Current draw	Approx. 500 mA (backplane bus) Approx. 140 mA (external)	Approx. 500 mA (backplane bus) Approx. 170 mA (external)
Ambient temperature	0 °C to +60 °C	0 °C to +60 °C
MPI interface		
Type	RS485	RS485
Transmission rate	19.2 or 187.5 kbps	19.2 or 187.5 kbps
Connector	SUB-D, 9-pin socket or via backplane bus	SUB-D, 9-pin socket or via backplane bus
USB communication interface		
Type	USB 2.0, USB 1.1 compliant	USB 2.0, USB 1.1 compliant
Connector	USB-B socket for internal modem or TS adapter	USB-B socket for internal modem or TS adapter
Transmission rate	9.6 kbps to 115.2 kbps through virtual COM port	9.6 kbps to 115.2 kbps through virtual COM port
Modem	Analog interface 56 kbps (V.92)	Quad band: GSM850, EGSM900, DCS1800, PCS1900
Modem port	RJ-11 socket	3V Mini-SIM card, FME connector for antenna
SMS dispatch	2	2
Transmission standards	V.90, V.34+, V.34, V.32 to, V.32, V.22, V.22 to, V.21, V.23, BELL standard 103, 212, fax class 1, fax class 2	Class 4 (2W) for GSM850/EGSM900 Class 1 (1W) for DCS1800/PCS1900

Antennas for GSM/UMTS/LTE

On this page you will find antennas for the REX 100 routers and for the REX 300, the TS 300, and the SSW7-TS with modem. Our technical sales is happy to help you with questions involving the various antennas.

GSM/UMTS/LTE antennas for REX 100

ORDERING DATA		ORDER NO.
Stationary outdoor antenna for REX 100, GSM/UMTS/LTE, 5 m cable, SMA socket		700-751-ANT31
Magnetic base antenna, indoor, for REX 100, GSM/UMTS/LTE, 3.5 m cable, SMA socket		700-751-ANT32
MiMo wall antenna for REX 100, GSM/UMTS/LTE, 2x5 m cable, SMA sockets		700-751-ANT35

TECHNICAL DATA	STATIONARY OUTDOOR ANTENNA 700-751-ANT31	MAGNETIC BASE ANTENNA 700-751-ANT32	MIMO WALL ANTENNA 700-751-ANT35
Amplification	LTE 800: 2 dBi GSM 900: 2 dBi GSM 1800, UMTS: 2 dBi WLAN: 2 dBi LTE 2600: 2 dBi	LTE 800: 5 dBi GSM 900: 5 dBi GSM 1800, UMTS: 7 dBi WLAN: 9 dBi LTE 2600: 9 dBi	LTE 800: 2 dBi GSM 900: 2 dBi GSM 1800, UMTS: 5 dBi WLAN: n. a LTE 2600: 4 dBi
Cable length	5 m	3.5 m	5 m
Diameter/width Height	35 mm 185 mm	70 mm 453 mm	155 mm 186 mm
Misc./Delivery package	Incl. retaining bracket (length 80 mm) and fastening material for wall assembly	Antenna is fastened to the magnetic base with a threaded connection	Incl. base and fastening bracket for pole assembly

GSM/UMTS antennas for REX 300, TS 300 and SSW7-TS with modem

ORDERING DATA	ORDER NO.
Stationary quad-band antenna, for REX 300, TS 300, SSW7-TS, GSM/UMTS, 2 dBi, 5 m cable, FME socket	700-751-ANT11
Magnetic base quad-band antenna, for REX 300, TS 300, SSW7-TS, GSM/UMTS, 2 dBi, 2.5 m cable, FME socket	700-751-ANT12
GSM antenna extension cable for REX 300, TS 300, SSW7-TS, FME socket/plug, 5 m	700-751-ANK01
GSM antenna extension cable for REX 300, TS 300, SSW7-TS, FME socket/plug, 10 m	700-751-ANK02
GSM antenna extension cable for REX 300, TS 300, SSW7-TS, FME socket/plug, 15 m	700-751-ANK03
GSM antenna extension cable for REX 300, TS 300, SSW7-TS, FME socket/plug, 20 m	700-751-ANK04



Infrastructure/Security

Bridge/Firewall
PROFINET switch

WALL IE, Industrial Ethernet Bridge and Firewall



WALL IE, Industrial Ethernet Bridge and Firewall

WALL IE, the Industrial Ethernet Bridge and Firewall, simply integrates your machinery network into the higher-level production network. A package filter protects the networks from unauthorized access. If identical IP address ranges are to be realized, WALL IE functions as a bridge.

The NAT operating mode serves the forwarding of the data traffic between various IPv4 networks. It enables the address translation via NAT and uses package filters for the limitation of access to the automation network located behind.

In the bridge operating mode, WALL IE acts as a layer 2 switch. In contrast with normal switches, however, package filtering is also possible in this operating mode. This means that the restriction of access to individual areas of your network can be achieved without having to use different networks for this purpose.

FEATURES

- Integration of machine networks into the higher-level plant network
- Bridge functionality for identical IP address ranges
- NAT: Basic NAT, NAPT, port forwarding
- Access restriction through package filters: IPV4 addresses, protocol (TCP/UDP), ports, MAC addresses (in development), Ether types (in development)
- 100 Mbps Industrial Ethernet
- Fast and easy configuration through responsive web interface
- Static routes to other networks
- Reporting of incidents to a Syslog server
- Industry-compatible design for installation on DIN rails

NAT operating mode

In the NAT operating mode, WALL IE forwards data traffic between various IPv4 networks (Layer 3).

Static routes are used for communication with other automation cells. To do so, the network and the address of the responsible router ("Next Hop") must be configured.

Bridge operating mode

In the bridge operating mode, WALL IE acts like a layer 2 switch between the automation cell and the production network. Nonetheless, the access between the two areas can be limited by the package filter. This allows the separation of a part of the production network without the use of different networks.

Package filter functionality

With the package filter, access between the production network and the automation cell can be limited. For example, it can be configured that only certain participants from the production network may exchange data with defined participants from the automation cell.

The following filter criteria at layers 3 and 4 are available: IPv4 addresses, protocol (TCP/UDP), ports. The layer 2 criteria MAC addresses and Ether types are in development.

NAT functionality

When several automation cells with the same address range are integrated into a production network, thus results in collisions, as the addresses in the entire network are not unique. Using Network Address Translation (NAT), WALL IE makes it possible to integrate several automation cells of the same type into the production network.

Basic NAT

Basic NAT, also known as "1:1 NAT" or "Static NAT", is the translation of individual IP addresses or entire address ranges. The translation takes place exclusively at the IP level, which means that all ports can be addressed without explicit forwarding.

NAPT: Network Address and Port Translation

NAPT, also known as "1:N NAT" or "Masquerading", is the translation of all addresses of the automation cell into a single address of the production network. The sender addresses of packages from the automation cell are replaced by these.

With the help of port forwarding, it can be configured that packages are forwarded to a certain TCP/UDP port of this address to a participant in the automation cell (e.g. 10.10.1.1:8080 to 192.168.10.2:80).

ORDERING DATA

WALLIE, Industrial Ethernet Bridge and Firewall (incl. Quick Start Guide)

ORDER NO.

700-860-WAL01

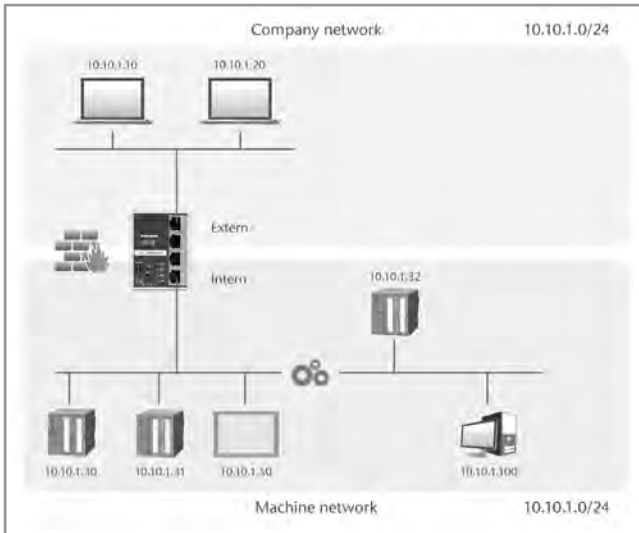

WALLIE, bridge operating mode with access restriction

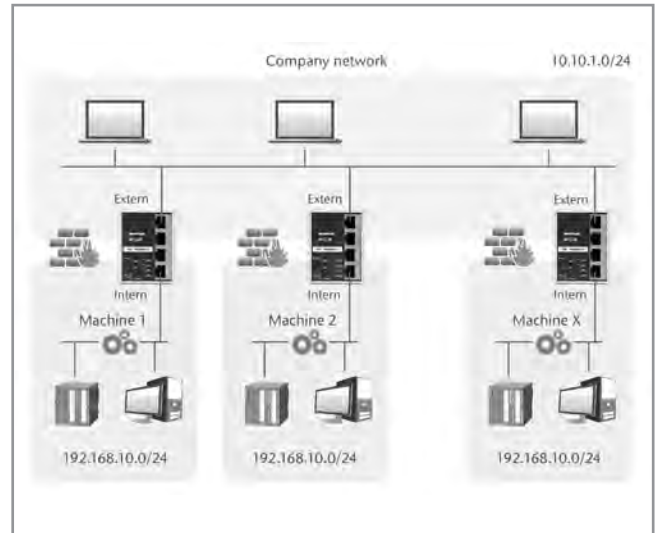

WALLIE, NAT functionality – same machines in the production network

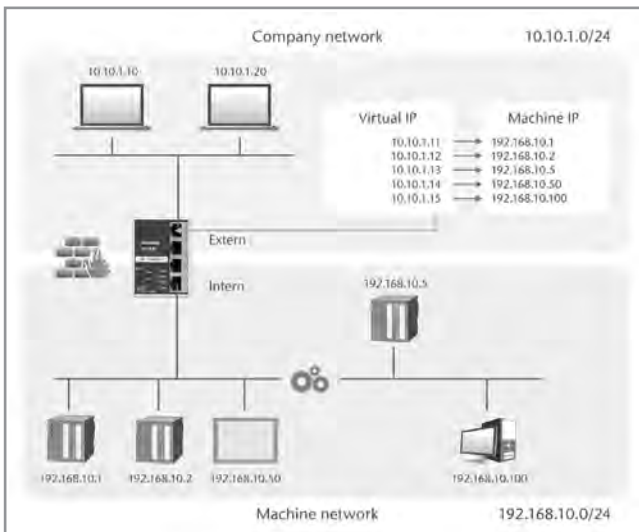

WALLIE, Basic NAT

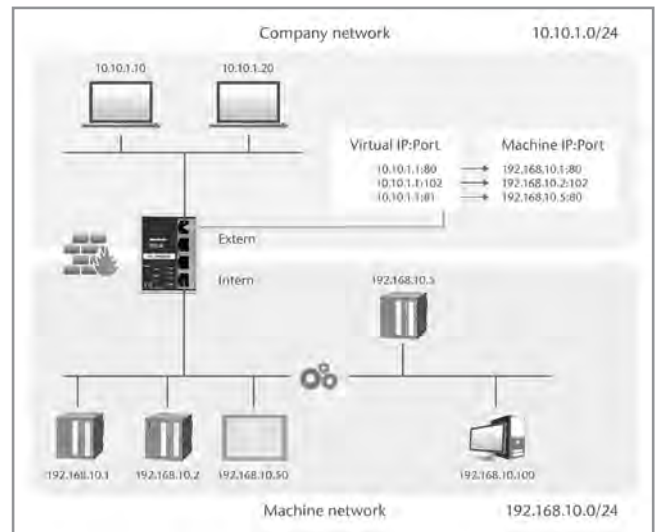

WALLIE, NATP: Network Address and Port Translation

TECHNICAL DATA

Dimensions (D x W x H)	35 x 59 x 75 mm
Weight	250 g
Number of inputs/switching point	2/DC 24 V, as per DIN EN 61131-2 Type 2
Interfaces	Four 10/100 Mbps LAN ports USB 2.0, mini USB
Operating modes	Bridge, Basic NAT, NATP
Package filter	IPv4 addresses, protocol (TCP/UDP), ports, MAC addresses (in development), Ether types (in development)
Status indicator	4 LEDs
Voltage	DC 18 V ... DC 30 V
Current draw	Max. 250 mA with DC 24 V
Ambient temperature	0 °C ... +60 °C (-20 °C ... +70 °C in development)
Transport and storage temperature	-20 °C ... +60 °C
Protection rating	IP20
Certifications	CE, GCF, FCC, PTCRB, IC

PROFINET Switch, 4-port, managed



PROFINET Switch, 4-port, managed

With the 4-port-managed PROFINET switch, PROFINET participants can be connected saving time and costs.

With a GSDML file, you integrate the 4-port switch into your automation environment as usual. The compact and industry-compatible design for DIN rail installation convinces, as does the web interface for configuration and diagnosis. It is also possible to carry out a diagnosis and/or configuration via Telnet, SSH or USB. The supported PROFINET protocols, such as LLPD, DCP or even diagnosis alarms, can be easily configured and administered. The transmission speed of up to 100 Mbit/s, which can be defined for each port, is as much a standard feature as the PROFINET Conformance Class B and the MRP Client for transmission security through ring redundancy.

PROFINET FUNCTIONS

- Allocation of a network configuration on the basis of the device name
- Definition of the transmission process and speed of a port (auto-negotiation or fixed setting up to 100 Mbits/s full-duplex)
- Activate/deactivate port
- Set DCP/LLDP boundary for a port
- Set up PROFINET switch as MRP client
- Device exchange without programming device

FEATURES

- PROFINET Conformance Class B
- Managed Switch with 4x100 Mbps RJ45 Ports
- Integration into the automation network with GSDML file
- Quick and easy configuration and diagnosis via web interface or PROFINET
- Configuration via command lines (Telnet, SSH, USB)
- LLPD, DCP, SNMP, diagnosis alarms
- Media redundancy: MRP client via ports 1+2
- Port mirroring
- Network statistics (frames and errors)
- Time synchronization via SNTP
- Firmware updates via web server
- Compact, industry-compatible design for installation on DIN rails

ORDERING DATA

PROFINET switch, 4-port, managed
(incl. Quick Start Guide)

ORDER NO.

700-850-4PS01

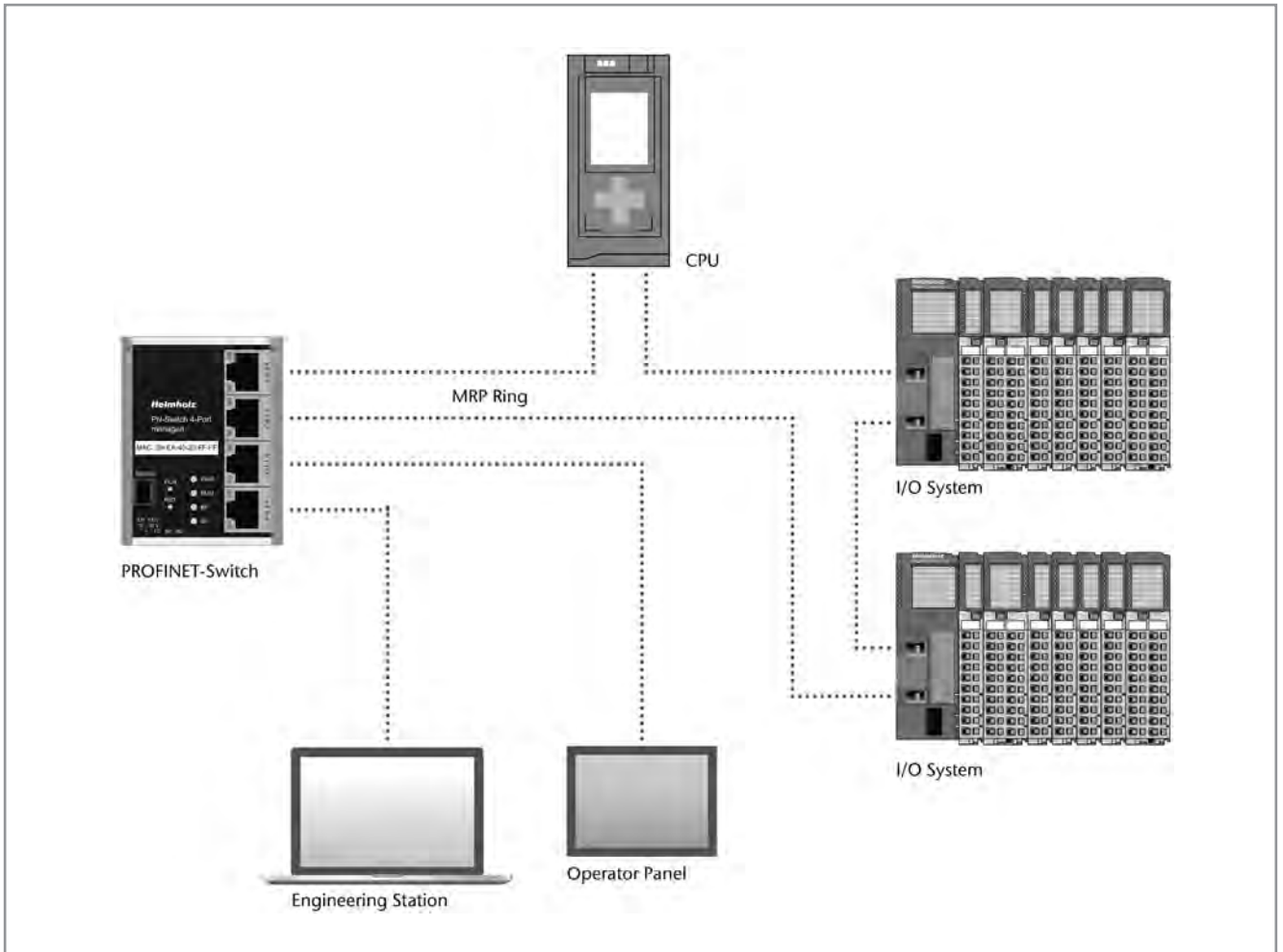

Application example for PROFINET Switch, 4-port, managed

TECHNICAL DATA

Dimensions (D x W x H)	35 x 59 x 75 mm
Weight	250 g
Number of inputs/switching point	2/DC 24 V, as per DIN EN 61131-2 Type 2
PROFINET interfaces	
· Protocol	PROFINET IO as defined in IEC 61158-6-10
· Physical layer	Ethernet
· Transmission rate	100 Mbps, full-duplex
· I/O image size	Up to 1440 bytes
· Connector	4 x RJ45, integrated switch
· Features	Conformance Class B; media redundancy (MRP); Automatic addressing/topology detection (LLDP, DCP)
USB interface	USB 2.0, mini USB
Status indicator	4 LEDs
Current draw	Max. 250 mA with DC 24 V
Ambient temperature	0 °C ... +60 °C (-20 °C ... +70 °C in development)
Transport and storage temperature	-20 °C ... +60 °C
Protection rating	IP20
Certifications	CE, GCF, FCC, PTCRB, IC



NETLink® gateways

Ethernet gateways

WLAN gateways

High-speed USB gateways

for MPI/PPI/PROFIBUS



NETLink® PRO PoE, PROFIBUS Ethernet gateway

The NETLink® PRO PoE for programming, configuring, and visualizing S7 PLCs draws its supply voltage through the CPU of the automation device, or optionally via externally supplied DC 24 V or a CAT5 network cable using a PoE power supply unit.

The 1.2 m long connecting cable is designed as an active cable and therefore does not affect bus participants installed in the system.

In general, the connection to each MPI/PROFIBUS connection of the bus system or directly at the interfaces of active and passive participants is also possible. The PG socket integrated in the connector housing allows connection of additional devices.

The NETLink® PRO PoE enables the implementation of TCP/IP on MPI/PPI/PROFIBUS with up to 32 simultaneous connection channels. With the switchable single-master operation, passive bus participants can be addressed. The integration of SCADA, HMI, and OPC applications is possible via the widely used ISO on TCP (RFC 1006) protocol. The applications are automatically detected and forwarded by the NETLink® PRO PoE.

The integrated web interface offers parameterization, diagnostic, and security features, and for functional enhancements the user can use our free diagnostic software SHTools to automatically perform firmware updates, for example. The software's latest version is available for download at www.helmholz.com.

ORDERING DATA

ORDER NO.

NETLink® PRO PoE, PROFIBUS Ethernet gateway (incl. 3 m Ethernet cable, Quick Start Guide, CD with software and manual)	700-881-MPI21
NETLink® PRO PoE, 35° cable connector for S7-400 ¹ (incl. 3 m Ethernet cable, Quick Start Guide, CD with software and manual)	700-881-MPI22
DIN rail adapter, short	700-751-HSH01
Power adapter, 24 V, for SSW7, NETLink®, and REX 300 devices	700-751-SNT01
NETLink® Ethernet Variants Manual, German/English	900-88X-MPI21

FEATURES

- RFC 1006 (ISO on TCP)
- CPU-to-CPU communication (with S7-300¹ and S7-400¹)
- Powered Device (PD) as defined in IEEE Standards 802.3af (POE) and 802.3at (POE+)
- Support for all common S7 engineering tools
- Dynamic address assignment using DHCP
- Security functions for securing TCP/IP access
- PLC write protection feature can be enabled and disabled
- Up to 16 TCP connections
- Up to 32 MPI/PROFIBUS connections
- Easy configuration via web interface
- Variables can be monitored on a browser window
- Support for configuring slave parameters
- Electrical isolation for MPI/PPI/PROFIBUS
- MPI/PPI/PROFIBUS from 9.6 kbps to 12 Mbps
- For S7-200¹, S7-300¹, S7-400¹

TECHNICAL DATA

Dimensions in mm (D x W x H)	102 x 54 x 30
Weight	Approx. 180 g
Power supply	
Voltage	DC 24 V ±25 %
Operating voltage PoE	48 V as per IEEE 802.3af/at
PoE power class	Class 1 (0.44 to 3.84 Watt)
PoE+	Type 1 (see 802.3af)
Current draw	max. 150 mA
Communication interface	
Type	10 Base-T 100 Base-TX
Socket	RJ45
Transmission rate	10/100 Mbps autom. detection
MPI/PPI/PROFIBUS	
Type	RS485, isolated
Transfer rate	max. 12 Mbps autom. detection
Connector	SUB-D, 9-pin with PG interface and repeater
Protocols	FDL, RFC 1006
Ambient temperature	0 °C ... +60 °C
Displays	3 LEDs, 2 of them bi-color
Protection rating	IP 20

1) S7-200, S7-300, and S7-400 are registered trademarks of Siemens AG.

NETLink® PRO Compact, PROFIBUS Ethernet gateway



NETLink® PRO Compact, PROFIBUS Ethernet gateway

The NETLink® PRO Compact combines flexibility with a compact design. Power is supplied to the NETLink® through the CPU of the automation device or externally with DC 24 V as an option. The network connection can be used with any standard Cat-5 cable, making cable lengths up to 100 meters feasible without additional components.

In general, the connection to each MPI/PROFIBUS connection of the bus system or directly at the interfaces of active and passive participants is also possible.

The PG socket integrated in the connector housing allows connection of additional devices. The NETLink® PRO Compact enables conversion from TCP/IP to MPI/PPI/PROFIBUS with up to 32 simultaneously open connection channels, and passive bus participants can be addressed with the switchable single-master operation.

The integration of SCADA, HMI, and OPC applications is possible via the widely used ISO on TCP (RFC 1006) protocol. The applications are automatically detected and forwarded by the NETLink® PRO Compact. The integrated web interface offers parameterization, diagnostic, and security features, and for functional enhancements the user can use our free diagnostic software SHTools to automatically perform firmware updates, for example. The software's latest version is available for download at www.helmholz.com.

ORDERING DATA

NETLink® PRO Compact,
PROFIBUS Ethernet gateway
(incl. 3 m Ethernet cable, Quick Start Guide,
CD with software and manual)

NETLink® Ethernet Variants Manual,
German/English

ORDER NO.

700-884-MPI21

900-88X-MPI21

FEATURES

- RFC 1006 (ISO on TCP)
- CPU-to-CPU communication (with S7-300¹ and S7-400¹)
- Power can be supplied by the CPU or, alternatively, by an external DC 24 V supply
- Support for all common S7 engineering tools
- Dynamic address assignment using DHCP
- Security functions for securing TCP/IP access
- PLC write protection feature can be enabled and disabled
- Up to 16 TCP connections
- Up to 32 MPI/PROFIBUS connections
- Easy configuration via web interface
- Variables can be monitored on a browser window
- Support for configuring slave parameters
- Electrical isolation for MPI/PPI/PROFIBUS
- MPI/PPI/PROFIBUS from 9.6 kbps to 12 Mbps
- For S7-200¹, S7-300¹, S7-400¹

TECHNICAL DATA

Dimensions in mm (D x W x H)	64 x 40 x 17
Weight	Approx. 110 g
Power supply	
Voltage	DC 24 V ±25 %
Current draw	max. 200 mA
Communication interface	
Type	10 Base-T 100 Base-TX
Socket	RJ45
Transmission rate	10/100 Mbps Autom. detection
MPI/PPI/PROFIBUS	
Type	RS485, isolated
Transfer rate	max. 12 Mbps, autom. detection
Connector	SUB-D, 9-pin with PG interface and repeater
Protocols	FDL, RFC 1006
Ambient temperature	0 °C ... +60 °C
Displays	2 LEDs, including a three- color LED (for general status information)
Protection rating	IP 20

1) S7-200, S7-300, and S7-400 are registered trademarks of Siemens AG.

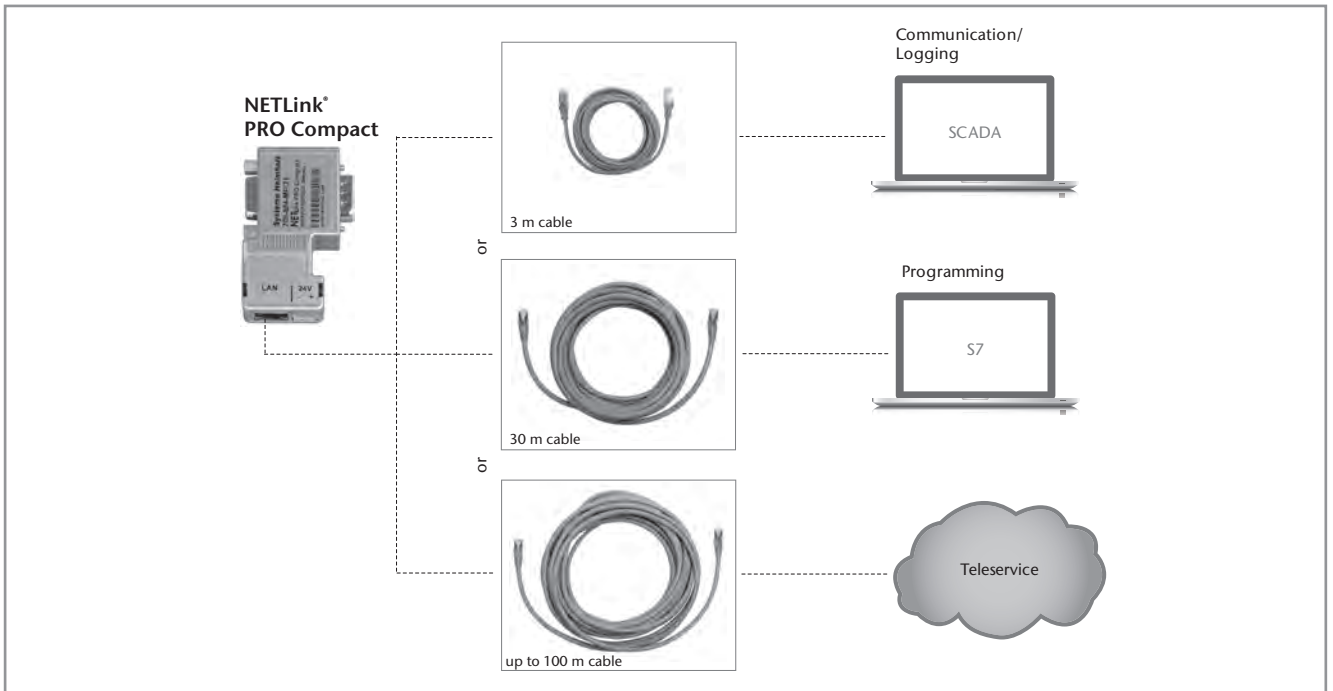

Application example NETLink® PRO Compact

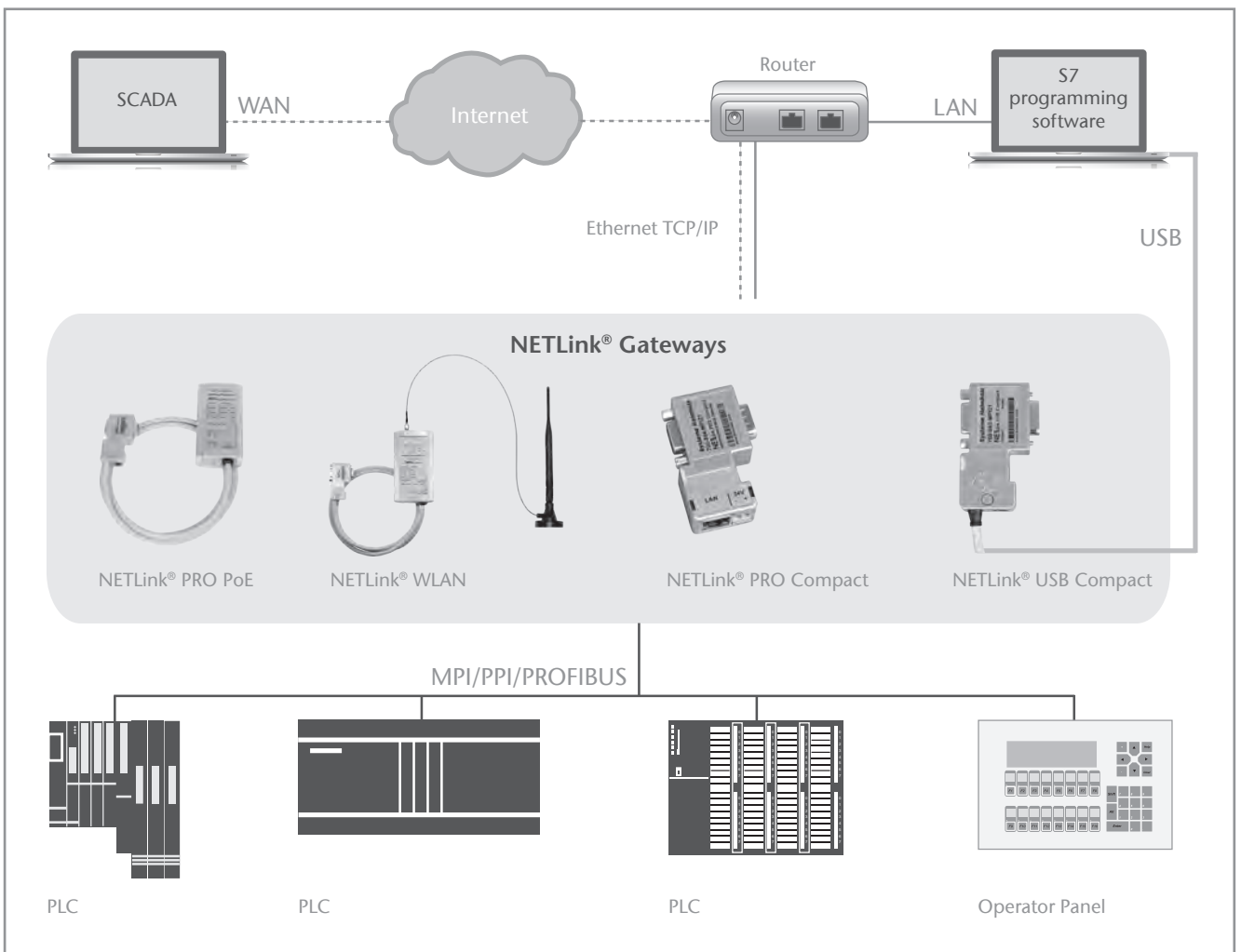

Application example for LAN-WAN connection via ISO on TCP



NETLink® WLAN, PROFIBUS Ethernet WLAN gateway

The NETLink® WLAN is an Ethernet Gateway with integrated WLAN function. The "Ad-hoc" or "Infrastructure" mode can be configured via the RJ45 socket or using a web interface. All standard wireless security methods are supported: WEP, WPA, and WPA2.

The NETLink® WLAN draws its supply voltage via the CPU of the automation device or via externally supplied DC 24 V. The 1.2 m long connection cable is designed as an active line and thus does not influence other participants installed in the system. In general, connection to each MPI/PROFIBUS connection of the bus system or directly at the interfaces of active and passive participants is also possible. The PG socket integrated in the connector housing allows connection of additional devices. The NETLink® WLAN enables implementation of TCP/IP on MPI/PPI/PROFIBUS with up to 32 simultaneous connection channels. With the switchable single-master operation, passive bus participants can be addressed. The integration of SCADA, HMI, and OPC applications is possible via the widely used ISO on TCP (RFC 1006) protocol. These are automatically recognized and forwarded by the NETLink® WLAN.

The integrated web interface offers configuration, diagnosis, and security functions. For function expansions, the user can independently carry out, for example, firmware updates with the free diagnosis software SHTools. The software's latest version is available for download at www.helmholz.com.

Accessories note

For antennas for WLAN, see page 32.

ORDERING DATA	ORDER NO.
NETLink® WLAN, PROFIBUS Ethernet WLAN gateway (incl. 3 m Ethernet cable, Quick Start Guide, CD with software and manual)	700-882-MPI21
DIN rail adapter, long	700-751-HSH10
Power adapter, 24 V, for SSW7, NETLink®, and REX 300 devices	700-751-SNT01
NETLink® Ethernet Variants Manual, German/English	900-88X-MPI21

FEATURES

- RFC 1006 (ISO on TCP)
- CPU-to-CPU communication (with S7-300¹ and S7-400¹)
- Connectable WLAN interface (802.11 b/g) with speeds of up to 54 Mbps
- Support for all common S7 engineering tools
- Dynamic address assignment using DHCP
- Security functions for securing TCP/IP access
- PLC write protection feature can be enabled and disabled
- Up to 16 TCP connections
- Up to 32 MPI/PROFIBUS connections
- Easy configuration via web interface
- Web interface diagnostic page with a layout that is easy to follow and understand
- Variables can be monitored on a browser window
- Support for configuring slave parameters
- Electrical isolation for MPI/PPI/PROFIBUS
- MPI/PPI/PROFIBUS from 9.6 kbps to 12 Mbps
- For S7-200¹, S7-300¹, S7-400¹

TECHNICAL DATA

Dimensions in mm (D x W x H)	130 x 68 x 30
Weight	Approx. 280 g
Power supply	
Voltage	DC 24 V ±25 %
Current draw	typ. 200 mA
Communication interface	
Type	10 Base-T 100 Base-TX
Socket	RJ45
Transmission rate	10/100 Mbps autom. detection
WLAN	
Type	IEEE 802.11b; 802.11g
Frequency range	2.412 ... 2.484 GHz
Transmission power	14 dBm +1.5 dBm/-1.0 dBm
Transmission speed	54 Mbps
Wireless security methods	WEP, WPA, WPA2
MPI/PPI/PROFIBUS	
Type	RS485, isolated
Transfer rate	max. 12 Mbps autom. detection
Connector	SUB-D, 9-pin with PG interface and repeater
Protocols	FDL, RFC 1006
Ambient temperature	0 °C ... +60 °C
Displays	5 LEDs, 2 of them bi-color
Protection rating	IP 20

1) S7-200, S7-300, and S7-400 are registered trademarks of Siemens AG.

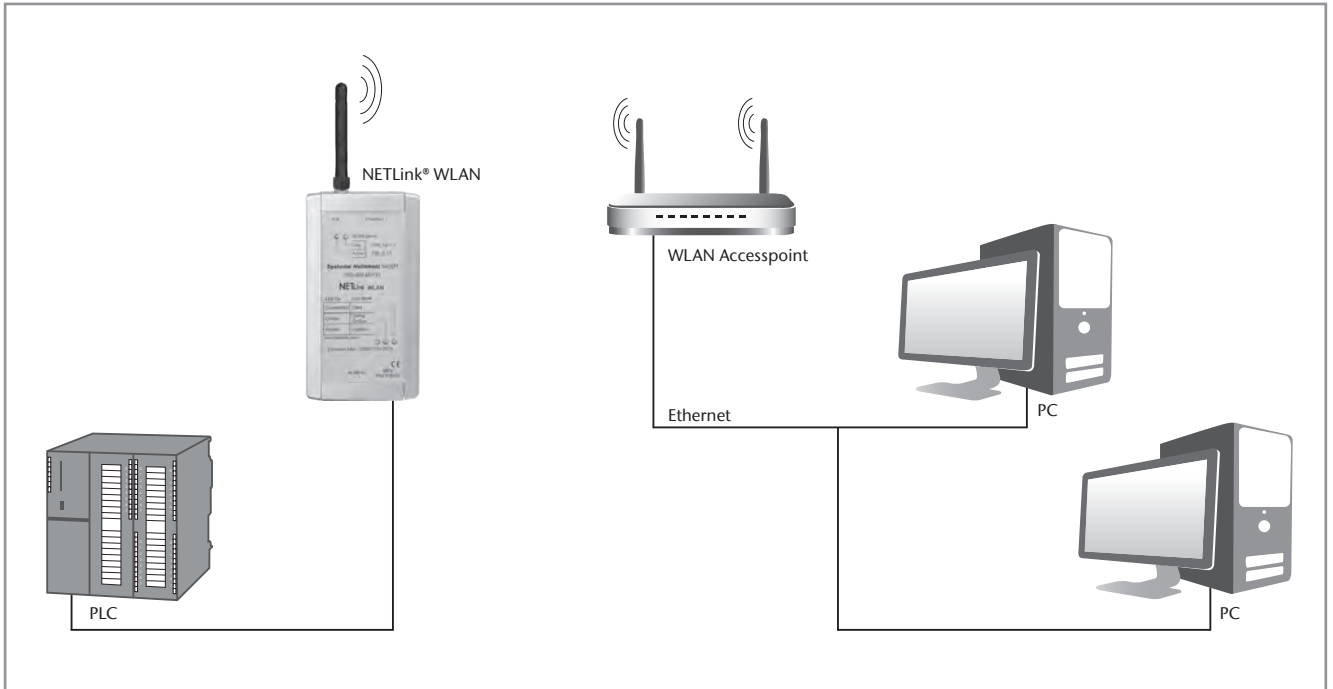

Application example NETLink® WLAN "Infrastructure" mode

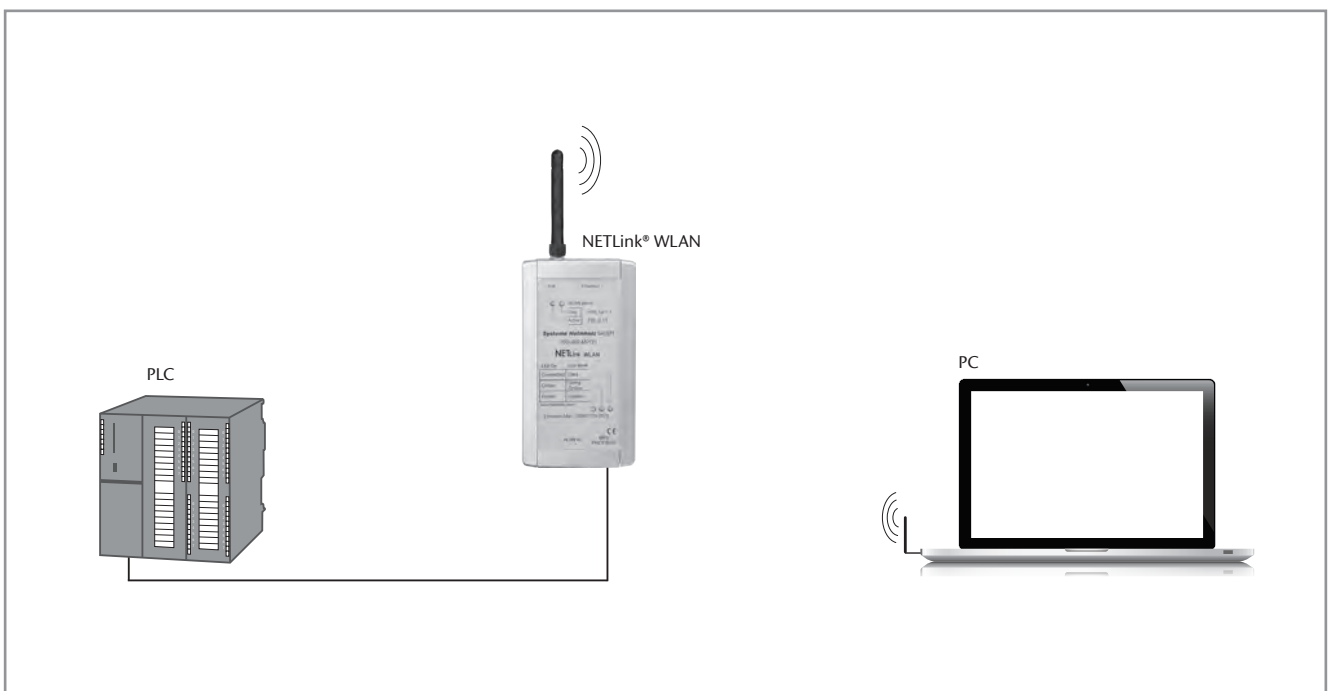

Application example NETLink® WLAN "Ad hoc" mode

WHAT ARE CPU-TO-CPU COMMUNICATIONS?

You can use S7 basic communication in order to implement a CPU-to-CPU connection. The MPI and PROFIBUS connection types are supported on all S7-300¹ and 400¹ PLCs.

The firmware of Siemens CPUs has system functions (SFCs) for transmitting data between two stations. All NETLink® Ethernet gateways support the S7 mechanisms X_PUT and X_GET (read and write data from/to a communication partner outside the local S7 station).

For this type of client-server communication, the well-known RFC1006 transport protocol (ISO on TCP) is used. On the receiving side (client), CPs or PROFINET CPUs that also support this protocol can also be used, for example.

The connections are not configured, but are explicitly established for the SFC call. A connection resource is therefore permanently assigned only for communication on the “active” side. The “passive” side responds to the requests of the active party and therefore only requires a resource when it establishes a connection. In use, this results in the advantage that function calls only need to be saved on the active side (server).

If a previously configured X_PUT/X_GET process is to be expanded by TCP/IP, only one additional X_PUT (with the parameters for the remote station – see graph on the bottom left) will be included in the program execution to open the communication channel via a NETLink® Ethernet gateway.

The amount of transferable useful data per communication order is limited to 76 bytes throughout the system.

For configuration support (also for beginners), Helmholz provides simple example projects for the STEP¹ 7 programming software at no cost. Based on the associated application description, the CPU-to-CPU communication can be realized in just a few steps.

ETHERNET CPU/CP TO MPI/PROFIBUS

As a function extension, all NETLink® Ethernet gateways now support the asynchronous data exchange function with the Siemens communication modules SFB14 (“GET”) and SFB15 (“PUT”).

These system function blocks are available in the Siemens CPUs and forward the readout or writing tasks through the NETLink® adapter, which is connected to the MPI or PROFIBUS interface of a remote CPU.

For this type of CPU-to-CPU communication, the network cable can be connected directly to an Ethernet CPU/CP with NETLink®. The corresponding non-specific S7 connection is assigned in the NetPro configurator using a PC station. Helmholz also provides an application description and a simple example project for this. A general function description can also be found in the original Siemens documentation.

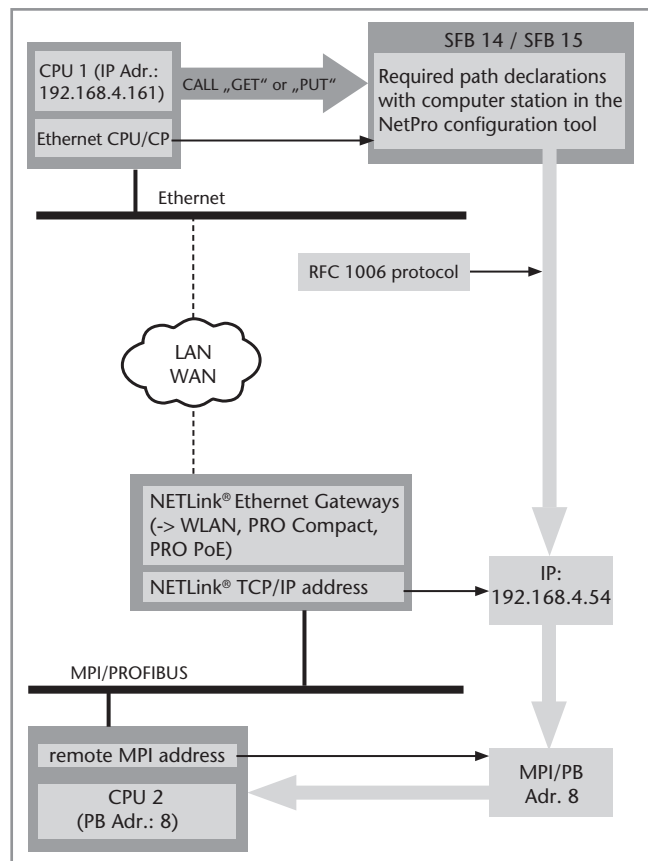
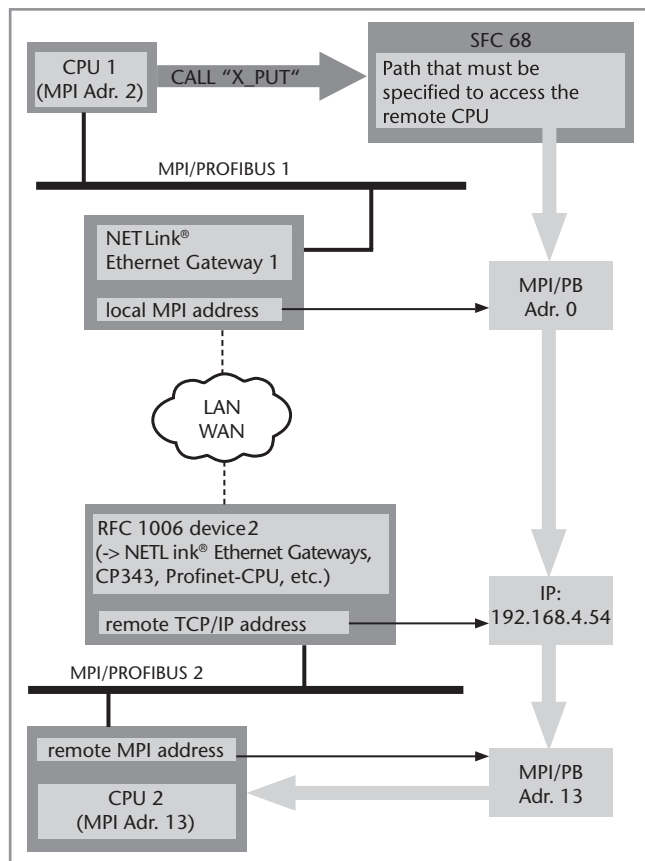

1) S7-200, S7-300, S7-400, and STEP are registered trademarks of Siemens AG.



NETLink® USB Compact, mini PROFIBUS USB gateway

The NETLink® USB Compact combines flexibility and a compact design with the advantages of plug and play. It can be integrated on each MPI/PROFIBUS interface of the bus system.

The PG socket integrated in the housing allows connection of additional devices. The connection to the PC is established with the 3 m high-speed USB cable.

The NETLink® USB Compact is supplied with voltage by the USB bus; on the USB side, the full-speed (12 Mbps) and high-speed (480 Mbps) protocols are supported.

The NETLink® USB Compact enables the implementation of a USB interface to the MPI/PROFIBUS for programming or visualization, with the full transmission rate of up to 12 Mbps and a maximum of 32 simultaneous links. The baud rate is detected automatically, and passive bus participants can be addressed in single-master operation mode. The supplied driver automatically integrates with the S7 Engineering Tools.

In addition, the MPI/PPI/PROFIBUS is electrically isolated from the USB interface (function separation).

SHTools is included as configuration and diagnostics software. This means that a firmware update can be performed automatically at any time for function extensions.

The software's latest version is available for download at no charge at www.helmholz.com.

ORDERING DATA

NETLink® USB Compact, mini PROFIBUS USB gateway
(incl. Quick Start Guide, CD with software and manual)

NETLink® USB Compact Manual,
German/English

ORDER NO.

700-892-MPI21

900-892-MPI21

FEATURES

- Support for all common S7 engineering tools
- Up to 32 MPI/PROFIBUS connections
- Support for configuring slave parameters
- Electrical isolation for MPI/PPI/PROFIBUS
- MPI/PPI/PROFIBUS from 9.6 kbps to 12 Mbps
- USB 2.0 with speeds of up to 480 Mbps (high-speed)
- Does not require a separate power supply
- Comes with female PG connector as standard
- For S7-200¹, S7-300¹, S7-400¹

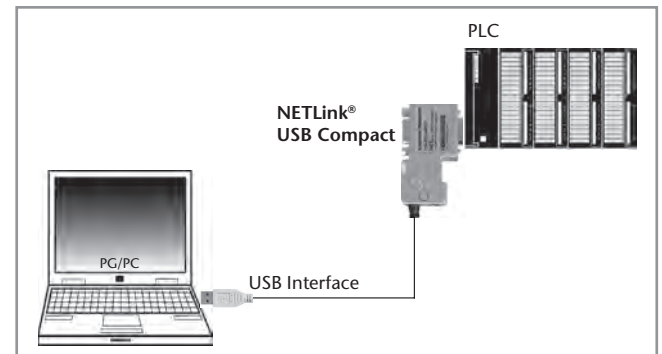

Application example for NETLink® USB Compact

TECHNICAL DATA

Dimensions in mm (D x W x H)	64 x 40 x 17
Weight	Approx. 115 g
Power supply	
Voltage	DC 5 V USB
Current draw	typ. 200 mA with DC 5 V USB
Communication interface	
Type	USB 2.0
Connector	USB-A socket
Transmission rate	12 Mbit full-speed/ 480 Mbit high-speed
MPI/PPI/PROFIBUS	
Type	RS485, electrically isolated
Transfer rate	max. 12 Mbps, autom. detection
Connector	SUB-D, 9-pin with PG Interface
Protocols	FDL
Ambient temperature	0 °C ... +60 °C
Displays	2 LEDs, including a three-color LED (for general status information)
Protection rating	IP 20

1) S7-200, S7-300, and S7-400 are registered trademarks of Siemens AG.

Quick access to S7/S5 data with 32/64-bit PC architecture

In the S7/S5 OPC server from version 4.10, the number of supported operating systems has been extended. It provides quick and convenient access to the process data of your PLCs. After installation on a Windows PC (XP/2003/Vista/2007/2008), the standardized OPC interface is available for data exchange with the following controllers, among others: S7-200¹/300¹/400¹, LOGO! 0BA7, WinAC¹, C7, and S5-CPU of the U-series. In this way any OPC-compliant client application can read and write the required input/output data, data blocks, markers, timers, and counters into the S7/S5 controllers. Addressing of the variables is consistently carried out in the familiar S7 semantics and can, if desired, be imported directly from an Excel file or an S7 project. An existing control program in your PLC does not need to be adapted for communication with the S7/S5 OPC server. This means that no detailed knowledge about the specific PLC program is required.

Flexible connectivity

For connecting your controllers to the S7/S5 OPC server, there are a variety of options available, such as TCP/IP, PROFIBUS, MPI, PPI, or AS511. In the S7/S5 OPC server configuration menu, up to 16 communication devices can be activated, with which parallel data exchange can then be implemented. Using the communication protocol TCP/IP (RFC1006), simultaneous access to up to 256 controllers is also possible in the maximum expansion stage. For communication, Helmholz offers the following communication adapters:

- All products in the REX and NETLink[®] family
- SSW7, SSW7-TS, SSW7-USB for MPI
- SSW3, SSW4 and SSW5 for AS511

Some communication modules from other manufacturers, such as Siemens CP 243, 343, and 443, are also supported. An improved license management system has been developed in order to optimize the USB drivers included with the hardware dongle so as to allow the use of licenses in virtual machines (VMWare³, ESX³, etc.).

Integrated web server

The S7/S5 OPC server has a built-in web server. This can be used for diagnosing the OPC server functions as well as for providing their own websites for operation and monitoring using any standard browser. The architecture and performance of the Web server is designed for smaller visualizations. In addition to supporting OPC Data Access 1.0a, 2.05, and 3.0, starting with this version non-Windows-based applications can use the S7/S5 OPC server using OPC XML DA. The latest OPC server version² is available for download (incl. all technical information) at www.helmholz.com.

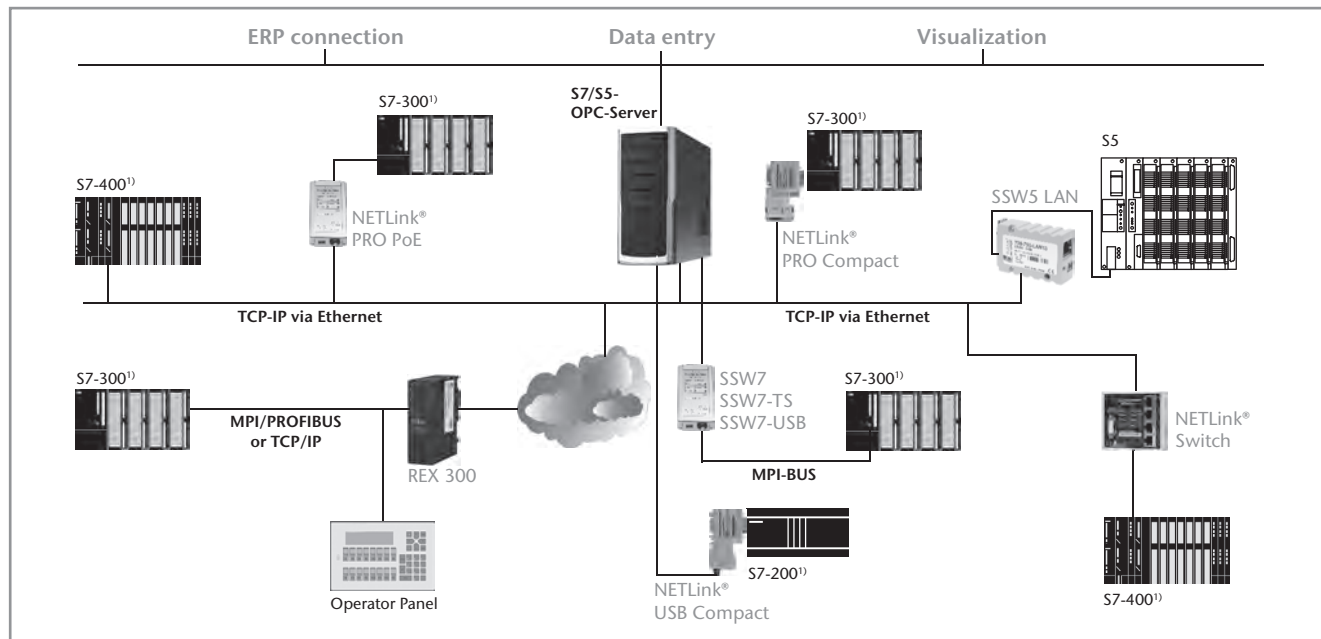
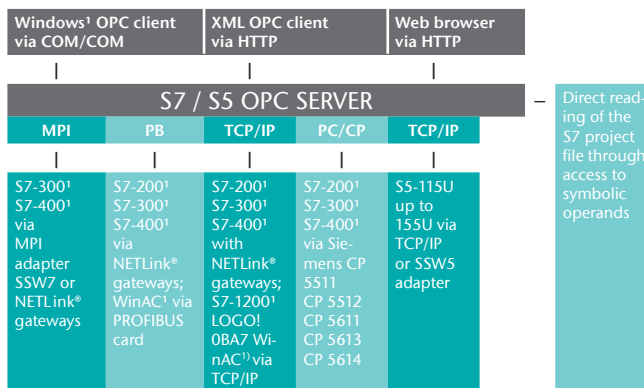

Application example for OPC Server

1) WinAC, S7-200, S7-300, S7-400, S7-1200, and WinCC are registered trademarks of Siemens AG. Windows is a registered trademark of Microsoft Corporation.
 2) Without a USB hardware dongle license, this full version can be used for 90 minutes in demo mode.
 3) VMware and ESX are registered trademarks of VMware Inc.

ORDERING DATA
S7 OPC server with USB dongle

ORDER NO.
800-880-OPC41



CAN 300 PRO, communication module

The CAN 300 PRO module, for use in an S7-300¹ from Siemens, enables connection of CAN participants with the automation device.

The module can be plugged into either the central frame or the expansion frame. It supports CAN 2.0A (11 bit) and CAN 2.0B (29 bit) telegrams with a freely selectable baud rate from 10 kbps to 1 Mbps.

The CAN 300 PRO can send and receive CAN telegrams in Layer 2 mode. In the CANopen[®] master mode, the data of the CANopen[®] slaves can be processed as a process map in the PLC.

Use as a CANopen[®] slave is also possible. For standard applications, such as motor control with CANopen[®], application examples are available. In addition, handling blocks for the SAE J1939 protocol are available.

There are 16 freely settable timers available in the CAN 300 PRO. Each timer can trigger a freely programmable CAN telegram. This means the synchronous protocols widely available in drive and servo control are easy to implement using the CAN 300 PRO.

A DIP switch for setting the baud rate and station address facilitates commissioning. An optional Micro memory card stores the project. In this way, replacement of the parameterization or the module during servicing can be carried out quickly.

6 LEDs indicate the operating status of the module. There is a USB interface for diagnostics and parameterization.

The CAN 300 PRO also works in the extended ambient temperatures of -25 °C to +60 °C.

A USB programming cable is included in the delivery.

ORDERING DATA

CAN 300 PRO, communication module
(incl. USB programming cable)

Micro memory card, 256 Kbyte

CAN 300 PRO Manual, German/English

CAN training (see also page 120)

ORDER NO.

700-600-CAN12

700-953-8LH30

900-600-CAN12

400-600-CAN01

FEATURES

- Layer 2, 11 bit and 29 bit (CAN 2.0 A/B)
- CANopen[®] master on the module
- DIP switches for address + baud rate
- Memory card for project backup (optional)
- USB interface for parameterization and diagnostics
- Extensive CAN bus diagnostic possibilities
- Can also be used as CANopen[®] slave
- Extended ambient temperature



Member of:

Note

On page 75 you will find information on the parameterization software CANParam and on the handling blocks for the PLC. In the first use, handling blocks for the PLC are needed.

TECHNICAL DATA

Dimensions in mm (D x W x H)	116 x 40 x 125
Weight	Approx. 280 g
Power supply Voltage	DC +5 V via backplane bus
Current draw	typ. 160 mA max. 190 mA
CAN interface Type	ISO/DIN 11898-2 CAN high-speed physical layer
Transmission rate	10 kbps to 1 Mbps
Protocol	CAN 2.0A (11 bit) CAN 2.0B (29 bit) CANopen [®] master CANopen [®] slave SAE J1939 DeviceNet slave (on request)
Connector	Connector, SUB-D, 9-pin
Status indicator	6 LEDs
Configuration interface Type	USB 1.1
Connector	USB-B socket
Ambient temperature	-25 °C ... +60 °C
Transport and storage temperature	-25 °C ... +75 °C

1) S7-300 is a registered trademark of Siemens AG.

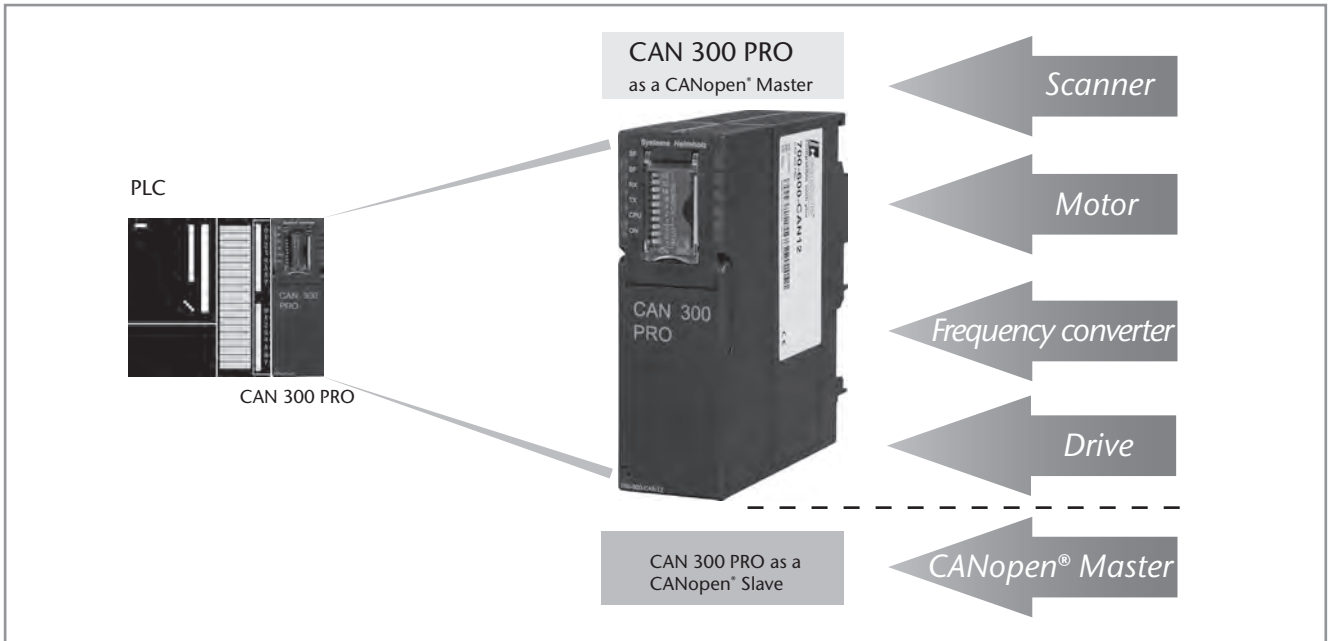

Application example of CAN 300 PRO as CANopen® master/slave

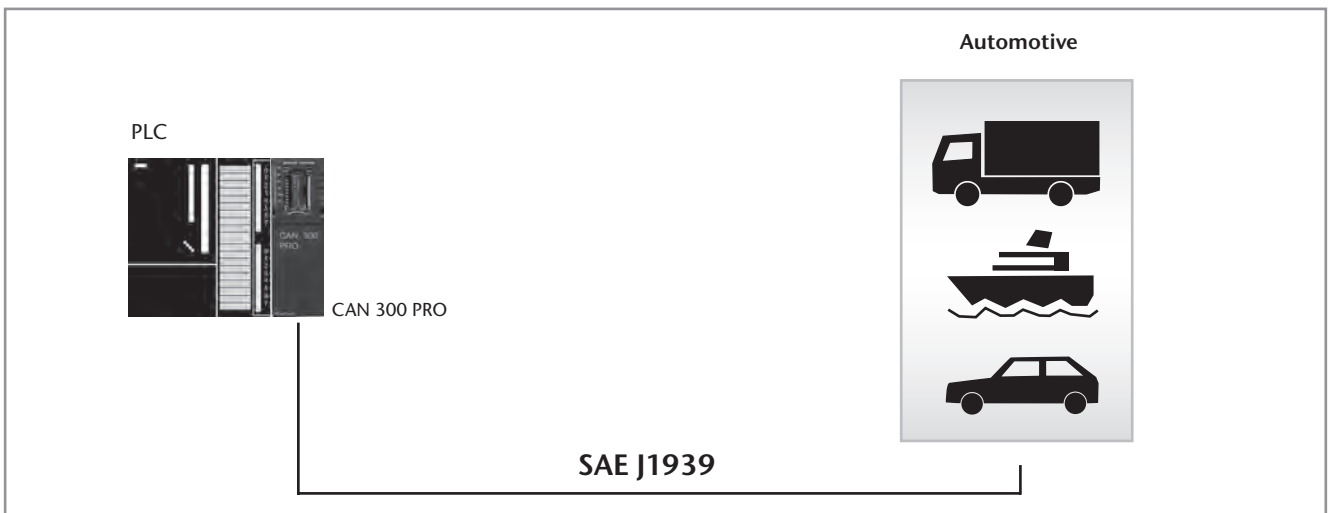

Application example CAN 300 PRO SAE J1939 protocol

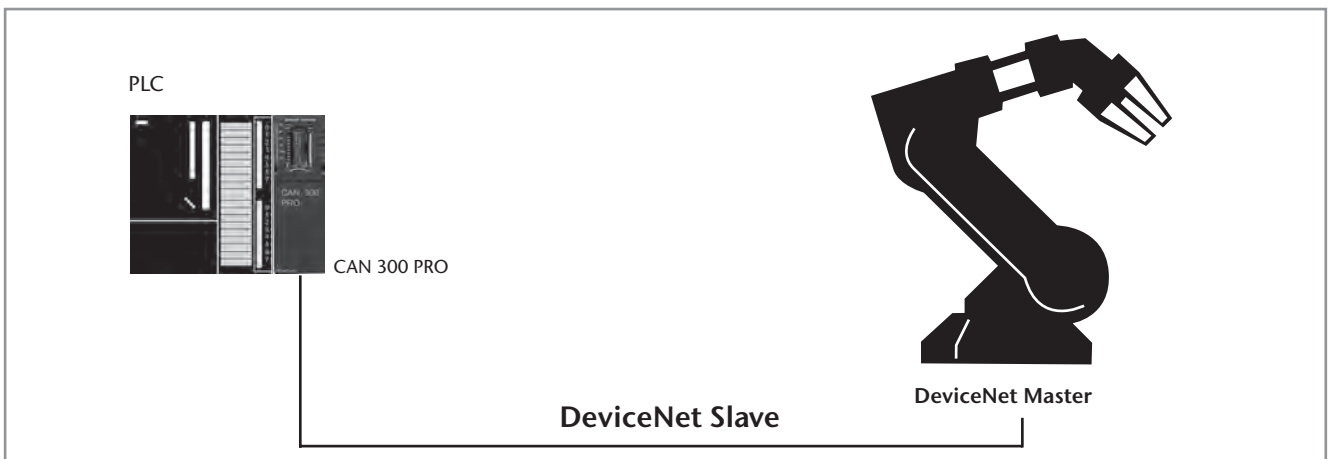

Application example CAN 300 PRO as DeviceNet slave

CAN 400, communication module



CAN 400, communication module

The CAN 400 module, for use in an S7-400¹ from Siemens, enables connection of CAN participants with the automation device. The module can be plugged into either the central frame or the expansion frame.

It supports CAN 2.0A (11 bit) and CAN 2.0B (29 bit) telegrams with a freely selectable baud rate from 10 kbps to 1 Mbps.

The CAN 400 can be operated as Layer 2, CANopen[®] master or CANopen[®] slave.

The module contains the scripts for “Power On”, “Stop -> Run”, “Run -> Stop”, “Power Off”. Using a multi-stage acceptance mask, relevant IDs can be pre-filtered for the automation device.

In the CAN 400, there are 16 freely settable timers up to a resolution of 1 ms. Each timer can trigger a freely programmable CAN telegram. This means the synchronous protocols widely available in drive and servo control are easy to implement using the CAN 400.

FEATURES

- Layer 2, 11 bit and 29 bit (CAN 2.0 A/B)
- DIP switches for address + baud rate
- USB interface for parameterization and diagnostics
- Extensive CAN bus diagnostic possibilities
- Can also be used as CANopen[®] master or CANopen[®] slave

CAN
connected

CANopen[®]

Member of: **cia**

Note

On page 75 you will find information on the parameterization software CANParam and on the handling blocks for the PLC. In the first use, handling blocks for the PLC are needed.

ORDERING DATA

ORDER NO.

CAN 400-1, communication module with 1 CAN interface	700-640-CAN11
CAN 400-2, communication module with 2 CAN interfaces	700-640-CAN21
CAN 400 Manual, German/English	900-640-CAN21
CAN training (see also page 120)	400-600-CAN01

1) S7-400 is a registered trademark of Siemens AG.

TECHNICAL DATA

	CAN 400-1	CAN 400-2
Dimensions in mm (D x W x H)	290 x 210 x 25	290 x 210 x 25
Weight	Approx. 900 g	Approx. 900 g
Power supply		
Voltage	DC +5 V via backplane bus	DC +5 V via backplane bus
Current draw	560 mA	600 mA
CAN interface		
Number	1	2
Type	ISO/DIN 11898-2, CAN High Speed physical layer	ISO/DIN 11898-2, CAN High Speed physical layer
Transmission rate	10 kbps to 1 Mbps	10 kbps to 1 Mbps
Protocol	CAN 2.0A (11 bit). CAN 2.0B (29 bit) CANopen [®] master, CANopen [®] slave SAE J1939	CAN 2.0A (11 bit). CAN 2.0B (29 bit) CANopen [®] master, CANopen [®] slave SAE J1939
Connector	Connector, SUB-D, 9-pin	Connector, SUB-D, 9-pin
Status indicators	6 LEDs	10 LEDs
Configuration interface		
Type	USB 1.1	USB 1.1
Connector	USB-B socket	USB-B socket
Ambient temperature	0 °C ... +60 °C	0 °C ... +60 °C
Transport and storage temperature	-25 °C ... +75 °C	-25 °C ... +75 °C

Parameterization tool CANParam

The CAN modules are configured on the PC with the parameterization tool CANParam (included in the software package 800-600-1AA11). This means the communication parameters can be easily set. The parameters for a module can be stored in a project on the PC.

The CAN modules support both the protocol format CAN 2.0A (11 bit) and CAN 2.0B (29 bit).

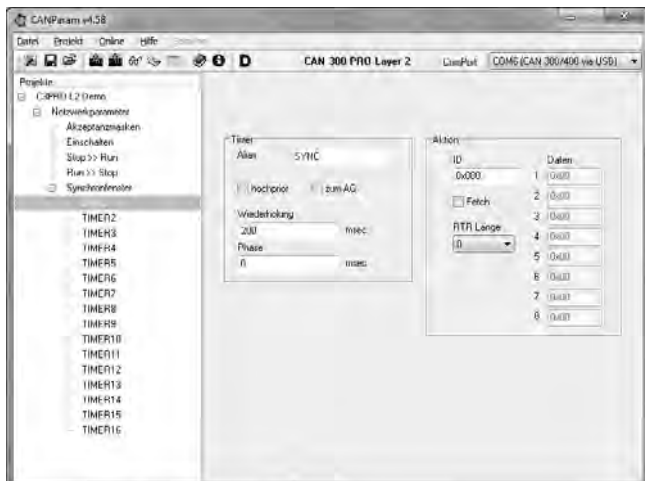

Acceptance masks are available in the CAN modules. Using these masks, it is possible to activate or block various telegram IDs for reception. Express masks filter high-priority CAN telegrams to pass them directly to the PLC.

For time-dependent events, such as the SYNC frame in CANopen®, up to 16 timers with a resolution of up to 1 ms are available in the CAN modules. Each timer can transmit any CAN telegram. The timers can be started, stopped, and changed from the PLC. In addition, synchronized transmission of CAN messages can be enabled. With this, a time window in which all data will be transmitted synchronously is specified.

Using freely programmable scripts, upon certain events, such as “Power ON” or “PLC Stop -> Run”, CAN messages can be sent or timers started.

An integrated diagnostic function facilitates troubleshooting during commissioning of the module.

For the CANopen® master function of the CAN 300 PRO, the behavior of the master can be defined and the slaves that exist in the CAN bus can be parameterized.

To simplify configuration, the CANParam software can read in the EDS files from CANopen® slaves.



Handling blocks

The CAN modules are entered in the hardware configurator of the programming software as CP module (CAN 300, CAN 300 PRO) or as FM module (CAN 400) and addressed in the STEP1 7 program / TIA Portal¹ using handling blocks.

For the CAN modules, handling blocks are available for Layer 2 communication and for the CANopen® master (DS301 V4). For use of the CAN modules as CANopen® slaves, handling for the profiles DS401 (IO modules) and DS420 (Corrugator) is available. Additional profiles can be prepared on request.

Functionality of the Layer 2 handling:

- Send CAN telegram
- Receive CAN telegram
- Start/stop timer
- Module reset
- CAN controller reset

With the handling blocks for Layer 2, any number of CAN protocols can be implemented in 11-bit and 29-bit mode.

Functionality of the CANopen® master handling:

- Read/send SDO
- SDO segmented download/upload
- Receive emergency
- Send/request PDO
- Node guarding / heartbeat monitoring
- Network management functions
- Error control

Application examples for control of drives according to profile DS402 are also available.

Furthermore, handling blocks for the application of the CAN 300 PRO as a DeviceNet slave are available.

ORDERING DATA

Handling blocks for CAN
CD with parameterization software
“CANParam”, handling blocks “Layer 2”,
“CANopen®”, and “SAE J1939”

ORDER NO.

800-600-1AA11

CANopen® slave handling

Upon request

Devicenet slave handling

Upon request

CAN training (see also page 120)

400-600-CAN01

1) STEP and TIA Portal are registered trademarks of Siemens AG.

DP/CAN coupler CANopen® Layer 2



DP/CAN coupler CANopen® Layer 2

The DP/CAN coupler integrates CANopen® devices into a PROFIBUS DP network. It is a full-fledged CANopen® master and supports network management, SYNC telegrams, and node guarding to monitor the participants.

On the PROFIBUS-DP, the DP/CAN coupler is a normal participant. The IO data of the CANopen® participants is shown in the PROFIBUS in a transparent and freely configurable manner.

The DP/CAN coupler is integrated in the hardware configurator with a GSD file and can be completely configured there. Additional tools are not necessary.

On PROFIBUS all standard transfer rates up to 12 Mbps are supported, on the CAN bus up to 1 Mbps.

The PROFIBUS address is set using a DIP switch.

Parameterization of the CANopen® participants using SDO telegrams and management of emergency messages is also possible. Alternatively, the DP/CAN coupler can also be used as a CAN Layer 2 device on the CAN bus. This makes it possible to also integrate customer-specific CAN protocols via PROFIBUS.

FEATURES

- Up to 15 CANopen® participants
- Up to 1 Mbps CAN baud rate
- Up to 12 Mbps PROFIBUS-DP
- Address setting using DIP switches
- Easy configuration via GSD file
- No handling blocks or parameterization software necessary
- CANopen® master and CAN Layer 2 possible
- Address and operating mode can be set via DIP switch
- 3 status LEDs
- Extended ambient temperature
- USB interface for firmware updates

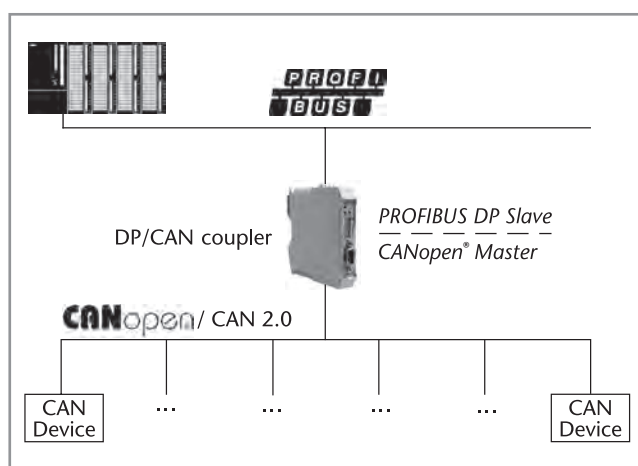

Application example DP/CAN coupler CANopen®

TECHNICAL DATA

Dimensions in mm (D x W x H)	114 x 18 x 108
Weight	Approx. 110 g
Power supply	
Voltage	24 V
Current draw	Approx. 180 mA
CAN interface	
Type	ISO/DIN 11898 -2 CAN high-speed physical layer
Transmission rate	10 kbps to 1 Mbps
Protocol	CANopen® master CAN 2.0A (11 bit)
Connector	Terminal, 3-pin
Status indicator	3 LEDs
PROFIBUS-DP interface	
Transfer rate	max. 12 Mbps, autom. detection
Protocol	PROFIBUS-DP as per EN 50 170
Connector	SUB-D socket, 9-pin
Ambient temperature	-25 °C ... +70 °C
Transport and storage temperature	-40 °C ... +75 °C
Relative humidity	max. 80 % at +20 °C, non-condensing
Protection rating	IP 20

ORDERING DATA

DP/CAN coupler CANopen® Layer 2
(incl. manual, CD with software)

ORDER NO.

700-650-CAN01



DP/CAN coupler Layer 2

The DP/CAN coupler Layer 2 allows you to connect any number of CAN participants to the PROFIBUS-DP. The DP/CAN coupler Layer 2 must be parameterized in the hardware configurator as a PROFIBUS participant. Corresponding GSD files are included with the device. The PROFIBUS side is configured as a DP slave; the interfaces correspond to EN 50170 and are electrically isolated. The baud rate from 9.6 kbps to 12 Mbps is automatically detected, and the size of the input and output information is up to 312 bytes. The CAN bus interface complies with ISO/DIN 11898-2 and is electrically isolated. The DP/CAN coupler can send and receive any CAN messages. Messages can be defined with a fixed identifier, whose data is always visible as a peripheral image in PROFIBUS. Alternatively, the DP/CAN coupler Layer 2 has a transmit and receive buffer for any CAN messages.

FEATURES

- Up to 1 Mbps CAN baud rate
- Up to 12 Mbps PROFIBUS-DP
- Address setting using DIP switches
- Easy configuration via GSD file
- No handling blocks or parameterization software necessary
- Any protocols via Layer 2 possible
- CAN 2.0 A (11 bit)
- CAN 2.0 B (29 bit)
- Timer for cyclical telegrams
- 3 status LEDs
- Extended ambient temperature
- USB interface for firmware updates

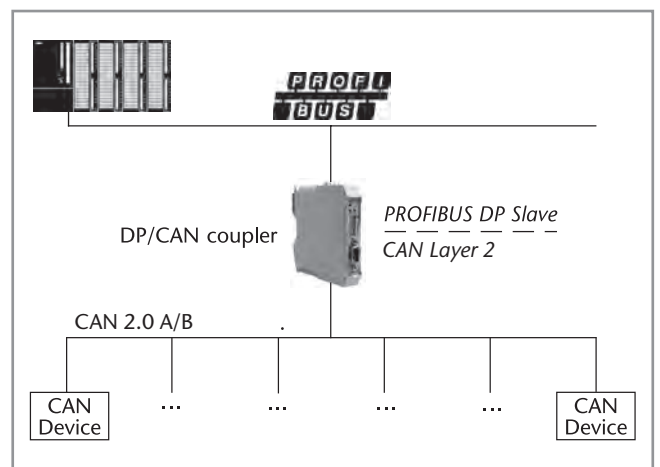

Application example DP/CAN coupler Layer 2

TECHNICAL DATA

Dimensions in mm (D x W x H)	114 x 18 x 108
Weight	Approx. 110 g
Power supply	
Voltage	24 V
Current draw	Approx. 180 mA
CAN interface	
Type	ISO/DIN 11898 -2 CAN high-speed physical layer
Transmission rate	10 kbps to 1 Mbps
Protocol	CAN 2.0A (11 bit) / CAN 2.0B (29 bit)
Connector	Terminal, 3-pin
Status indicator	3 LEDs
PROFIBUS-DP interface	
Transfer rate	max. 12 Mbps, autom. detection
Protocol	PROFIBUS-DP as per EN 50 170
Connector	SUB-D socket, 9-pin
Ambient temperature	-25 °C ... +70 °C
Transport and storage temperature	-40 °C ... +75 °C
Relative humidity	max. 80 % at +20 °C, non-condensing
Protection rating	IP 20

ORDERING DATA

DP/CAN coupler Layer 2
(incl. manual, CD with software)

ORDER NO.

700-651-CAN01

Bus connector for CAN Bus



CAN Bus connector, 90° cable outlet

The bus connectors for the CAN bus are used to connect a CAN bus participant to the CAN bus line. The connector is quickly mounted and has an integrated, connectable terminating resistor.

Helmholz offers you the bus connector with vertical cable outlet and for transmission rates up to 1 Mbps.

The bus connector is plugged directly onto the CAN bus interface (SUB-D socket, 9-pin) of the CAN bus participants. The CAN bus cables are connected using 6-pin screw terminals.

A slide switch is used to set whether the connector is to be used as a node or at the segment end. The switch can also be operated in the installed condition. The setting is clearly visible.

In node setting ("OFF"), the connector must be operated when the incoming and outgoing bus are connected to each other. The terminating resistor is then ineffective.

As segment end ("ON"), the connector must be set on the first and last (outermost) participants of the segment. In this case the terminating resistor is connected on the incoming bus, and the outgoing bus is disconnected.

The bus connectors for CAN bus are also available in axial design and with 24 V supply for participant supply.

The CAN connectors also work in the extended ambient temperature range of -25 °C to +85 °C¹.

ORDERING DATA

	ORDER NO.
CAN Bus connector 90°, without additional device connection	700-690-1BA12
CAN Bus connector 90°, with additional device connection	700-690-1BB12
CAN Bus connector, axial	700-690-0CA12



CAN Bus connector, axial

FEATURES

- 24 V supply for participant supply (only at 90°)
- Metalized housing
- No parts that can be lost
- 90° and axial cable outlet available
- Small size



Member of:



TECHNICAL DATA

Socket	
Order No. 700-690-1BB12	Yes
Order No. 700-690-1BA12	No
Order No. 700-690-0CA12	No
Dimensions in mm (D x W x H)	
700-690-1BB12/690-1BA12	64 x 40 x 17
700-690-0CA12	68 x 35 x 17
Weight	Approx. 40 g
Terminating resistor	Resistor 120 Ω, integrated and can be switched with slide switch
Transfer rate	max. 1 Mbps
Interfaces	
CAN bus participants	SUB-D socket, 9-pin
CAN bus cable	6 serial terminals for wires up to 0.5 mm ²
Maximum outside diameter	8.0 mm
Ambient temperature	-25 °C ... +85 °C ¹
Transport and storage temperature	-25 °C ... +85 °C
Relative humidity	max. 75% at +25 °C
Protection rating	IP 20

1) The maximum ambient temperature for UL is 60 °C.



CAN Bridge, connecting CAN networks

The CAN bridge makes it possible to connect two CAN networks of the same type or of different types. It can be used as a message repeater to expand network distances, as well as to connect different CAN networks together. It is immaterial whether the CAN networks have different baud rates or work with different protocols, such as CANopen® and a proprietary protocol. A flexibly adjustable filtering logic can accept freely selectable identifiers and transfer them to the other network. The CAN messages are forwarded to the respective other CAN network according to the store-forward principle and sent out again. With the CAN bridge, the CAN networks are physically decoupled (electrical isolation) and the bus load is reduced on both CAN networks. The CAN bridge allows a flexible design of the network topology; star and tree structures as well as extensive line structures can be implemented. The CAN bridge can be configured for simple applications using the two rotary coding switches. For more complex applications, the supplied CAN bridge parameterization software can be used to flexibly adjust the filtering and forwarding of CAN telegrams. Up to 256 range filters are available, along with up to 4 bit filters for address filtering. The configuration is imported through a USB interface and can also be read out again. The CAN bridge works both in 11-bit and 29-bit mode, and can communicate with baud rates from 10 Kbaud to 1 Mbaud. It has a powerful microcontroller that can operate even with extremely high data rates and bus loads without loss of messages. 5 LEDs indicate the status of the device and the connected CAN networks.

FEATURES

- Enlargement of the network scope
- Connect different CAN networks (different baud rates / different protocols)
- Physical disconnection (electrical isolation)
- Reduced bus load on both CAN networks
- Autobaud detection
- Easy configuration mode
- For use with CAN 2.0A & 2.0B, CANopen®, DeviceNet, SAE J1939
- DIN rail mounting

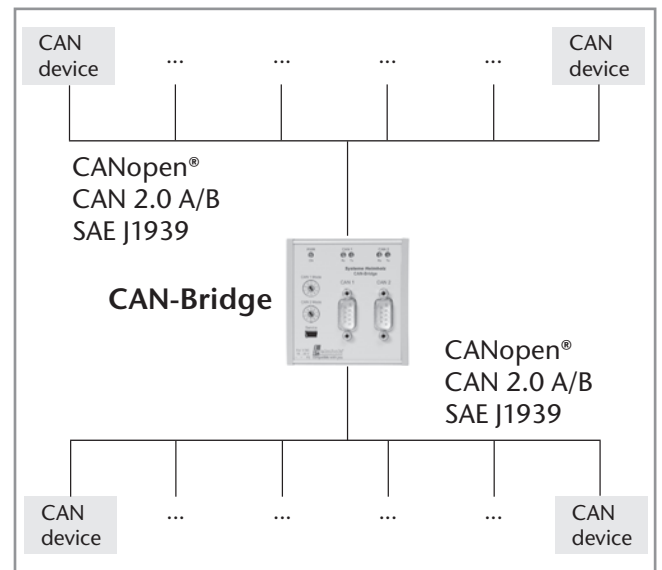

TECHNICAL DATA

Dimensions in mm (D x W x H)	31 x 74 x 75
Weight	Approx. 130 g
Power supply	
Voltage	18–30 V DC
Current draw	typ. 35 mA max. 60 mA
CAN interfaces	
Type	2 x ISO/DIN 11898-2 CAN high-speed physical layer
Transmission rate	10 kbps to 1 Mbps
Protocol	CAN 2.0A (11 bit) CAN 2.0B (29 bit) CANopen® SAE J1939 DeviceNet
Connector	2 x connector, SUB-D, 9-pin
Status indicator	5 LEDs
Configuration interface	
Type	USB 1.1
Connector	Mini USB socket
Ambient temperature	-25 °C ... +60 °C
Transport and storage temperature	-25 °C ... +75 °C

ORDERING DATA

CAN Bridge, connecting CAN networks
2 x CAN bus connections (incl. manual,
software and USB programming cable)

ORDER NO.

700-660-2AA01



PN/CAN Gateway

The PN/CAN gateway connects CANopen® devices in a PROFINET network. At the same time, it is a full-fledged CANopen® master. As the master, it supports gateway network management, SYNC telegrams, and node guarding / heartbeat for monitoring the participants.

On the PROFINET network, the PN/CAN gateway is a PROFINET IO device that supports transfer rates up to 100 Mbps full duplex, and on the CAN bus up to 1 Mbps is supported.

The IO data (PDOs) of the CANopen® participants is transparently displayed in a freely configurable manner in the PROFINET network and can be processed directly in the PLC.

The PN/CAN gateway is integrated with a GSDML file in the hardware configurator and can be completely configured there.

Other software tools for parameterization or handling blocks for programming are not required.

Parameterization of the CANopen® participants using SDO telegrams and management of emergency messages is also possible.

Device variants with CAN Layer 2 and CANopen® Slave are in development.

FEATURES

- PROFINET IO device as per IEC 61158-6-10
- Integrated 2-port switch
- Full duplex 100 Mbps transmission rate
- Conformance class B
- Media Redundancy Protocol (MRP)
- Up to 127 CANopen® participants
- Up to 1 Mbps CAN baud rate
- Easy configuration via GSDML file, no handling blocks or parameterization software necessary
- CANopen® master and CAN layer 2 possible
- Up to 16 PDOs per CANopen® slave
- SDO communication, emergency messages, participant monitoring with heartbeat and node guarding
- Extensive diagnostic functions
- 3 two-color status LEDs
- USB interface for online diagnostics and firmware update
- DIN rail mounting

TECHNICAL DATA

Dimensions in mm (D x W x H)	35 x 83 x 72
Weight	Approx. 160 g
Power supply	
Voltage	24 V
Current draw	max. 250 mA
CAN interface	
Type	ISO/DIN 11898-2 CAN high-speed physical layer
Transmission rate	10 kbps to 1 Mbps
Protocol	CANopen® master
Connector	Connector, SUB-D, 9-pin
PROFINET interfaces	
Protocol	PROFINET IO as per IEC 61158-6-10
Physical layer	Ethernet
Transmission rate	100 Mbps, full-duplex
I/O image size	Up to 1440 bytes
Connector	2 x RJ45, integrated switch
Features	Conformance class B, Media Redundancy Protocol (MRP), automatic addressing / topology detection (LLDP, DCP)
Status indicator	3 two-color LEDs
Ambient temperature	0 °C ... +60 °C
Transport and storage temperature	-25 °C ... +75 °C
Protection rating	IP 20

ORDERING DATA

PN/CAN gateway, PROFINET/CANopen®
(incl. Quick Start Guide, CD with GSDML file
and manual)

ORDER NO.

700-670-PNC01

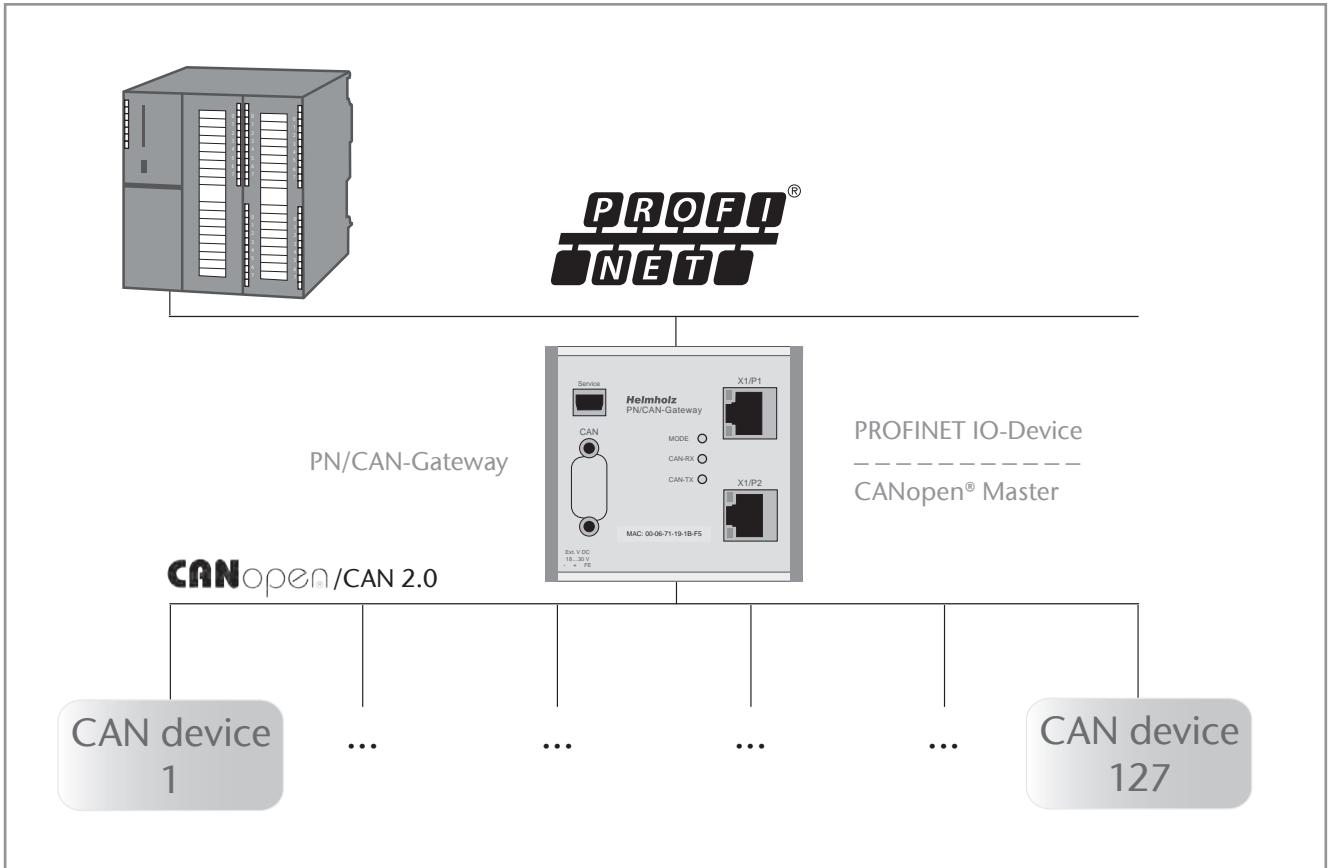

Application example for PN/CAN gateway



Components for S7

- Memory cards
- Micro memory cards
- Digital modules
- Analog modules
- Front connector

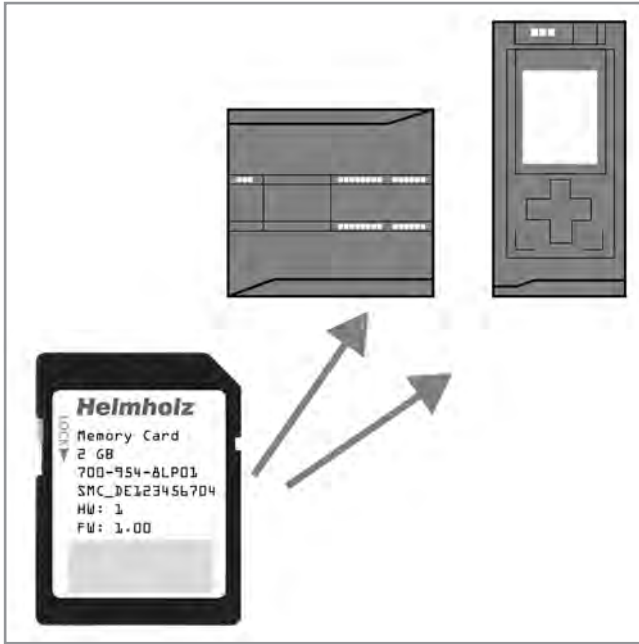

Memory cards for the 1200/1500 series

The memory cards are suitable for use in S7-1200¹/S7-1500¹ controllers of Siemens AG. They are available in the following memory sizes: 4 MB, 12 MB, 24 MB, 256 MB and 2 GB.

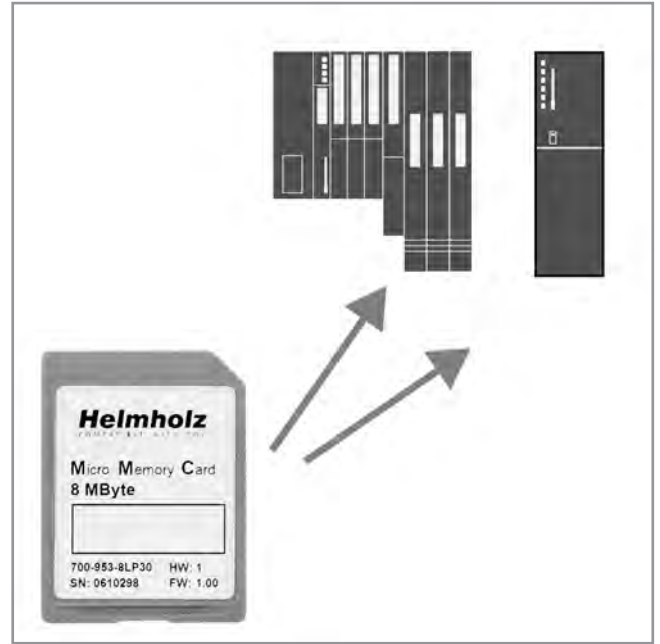

Micro memory card for the 300 series

The Micro memory cards are suitable for use in the S7-300¹ and ET200¹S CPU controllers of Siemens AG. Our product range includes the entire range of the most popular modules plus the special variants 256 kB and 1 MB. The Micro memory cards are available in the following memory sizes: 64 kB, 128 kB, 256 kB, 512 kB, 1 MB, 2 MB, 4 MB, and 8 MB.

TECHNICAL DATA 1200/1500 MEMORY CARDS

Storage volume	4 MByte 12 MByte 24 MByte 256 MByte 2 GByte
Application options	CPU 1200 CPU 1500

TECHNICAL DATA 300MICRO MEMORY CARDS

Storage volume	64 Kbyte 128 Kbyte 256 Kbyte 512 Kbyte 1 MByte 2 MByte 4 MByte 8 MByte
Application options	CPU 312C CPU 313C CPU 314C CPU 312 ... 317 IM 151, IM 153, IM 154 CPU C7

ORDERING DATA

ORDER NO.

Memory cards for the 1200/1500 series	
4 MByte	700-954-8LC01
12 MByte	700-954-8LE01
24 MByte	700-954-8LF01
256 MByte	700-954-8LL02
2 GByte	700-954-8LP01

ORDERING DATA

ORDER NO.

Micro memory cards for the 300 series	
64 Kbyte	700-953-8LF30
128 Kbyte	700-953-8LG30
256 Kbyte	700-953-8LH30
512 Kbyte	700-953-8LJ30
1 MByte	700-953-8LK30
2 MByte	700-953-8LL30
4 MByte	700-953-8LM30
8 MByte	700-953-8LP30

1) S7-300, S7-1200, and S7-1500, and ET 200 are registered trademarks of Siemens AG.

DEA 300, digital input module



Digital input module, 16 and 32 inputs

Accessories note

Front connectors and preassembled cables are available as accessories (see pages 106-109).

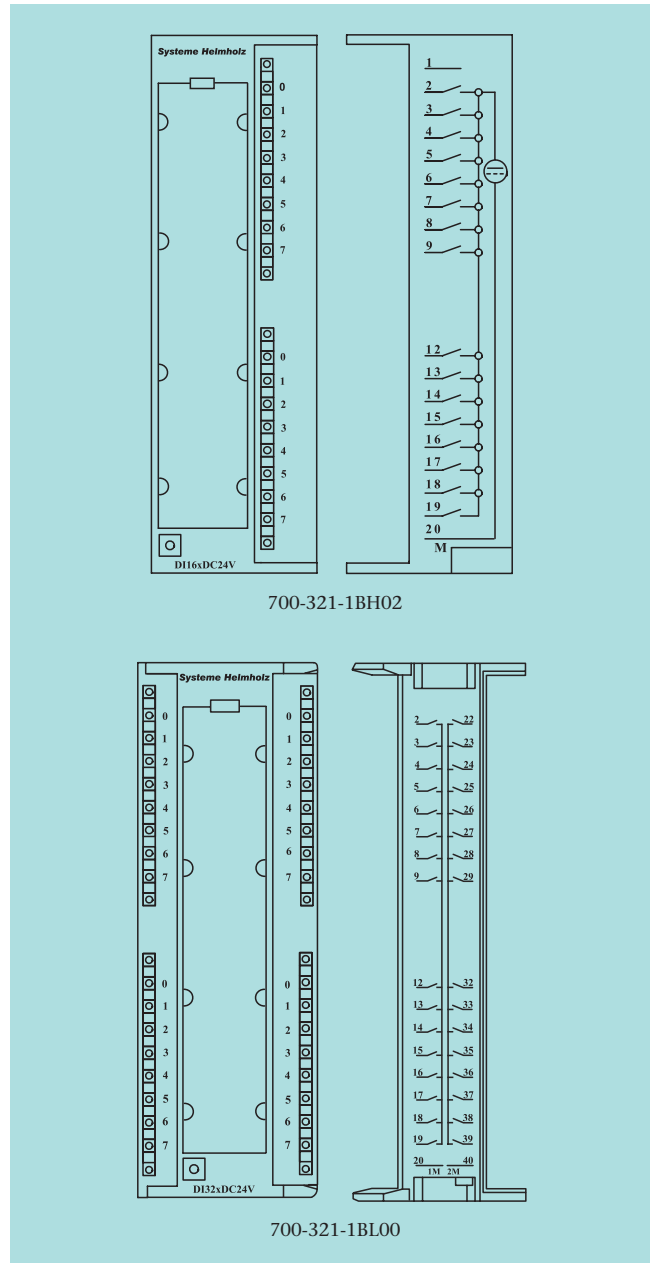

Open-type programmable controllers for use in hazardous locations, Class I, Div. 2 Groups A, B, C, D T4 including Class I Zone 2 IIC.

**ORDERING DATA**

DEA 300, digital input module
16 inputs (DC 24 V)
32 inputs (DC 24 V)

DEA 300 Manual, German/English

ORDER NO.

700-321-1BH02

700-321-1BL00

900-321-1DE11

TECHNICAL DATA	700-321-1BH02	700-321-1BL00
Number of inputs	16	32
Electrically isolated (from backplane bus) in groups to	Yes (optocoupler) 16	Yes (optocoupler) 16
Input voltage · Rated value · For signal "0" · For signal "1"	DC 24 V -3 ... +5 V +13 ... +30 V	DC 24 V -3 ... +5 V +13 ... +30 V
Input current · For signal "1"	typ. 7 mA	7 mA
Delay time	typ. 1.2 ... 4.8 ms	1.2 ... 4.8 ms
Can accommodate 2-wire initiator Permitted bias current for signal "0"	Yes max. 1.5 mA	Yes 1.5 mA
Cable length · Unshielded · Shielded	max. 600 m max. 1000 m	600 m 1000 m
Current draw · Internal (backplane bus) · External (from +24 V)	typ. 20 mA max. 140 mA	30 mA 290 mA
Power dissipation (nominal operation)	typ. 3.5 W	6.8 W
Front connector	20-pin	40-pin
Ambient temperature Transport and storage temperature	0 °C ... +60 °C -25 °C ... +75 °C	0 °C ... +60 °C -25 °C ... +75 °C

DEA 300, digital output module



Digital output modules, 16 and 32 outputs

Accessories note

Front connectors and preassembled cables are available as accessories (see pages 106-109).



Open-type programmable controllers for use in hazardous locations, Class I, Div. 2 Groups A, B, C, D T4 including Class I Zone 2 IIC.

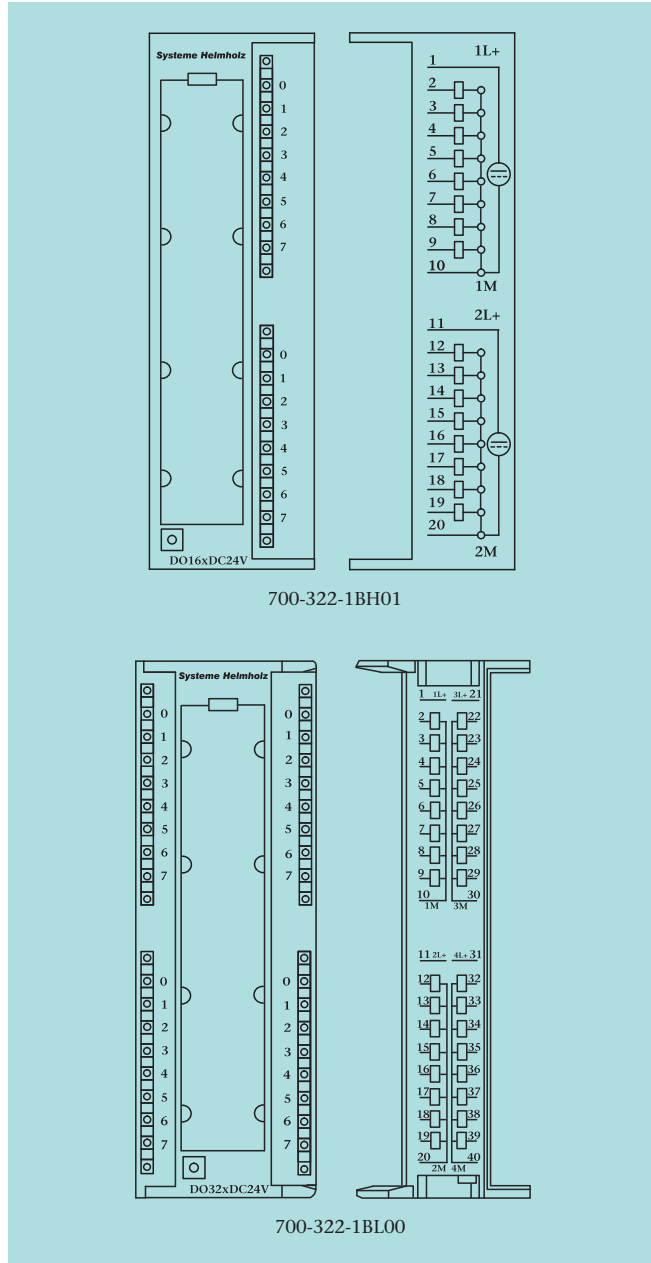

ORDERING DATA

DEA 300, digital output module	
16 outputs (DC 24 V, 0.5 A)	700-322-1BH01
32 outputs (DC 24 V, 0.5 A)	700-322-1BL00
DEA 300 Manual, German/English	900-321-1DE11

ORDER NO.

TECHNICAL DATA	700-322-1BH01	700-322-1BL00
Number of outputs	16	32
Electrically isolated (from backplane bus) in groups to	Yes (optocoupler) 8	Yes (optocoupler) 8
Supply voltage U_{pr}, U_s		
· Rated value	DC 24 V	DC 24 V
· Ripple U_{rs}	max. 3.6 V	3.6 V
· Permissible range (with ripple)	20 ... 30 V	20 ... 30 V
· Value for $t < 10$ ms	max. 50 V	50 V
Output current		
· Rated value	0.5 A	0.5 A
Short-circuit protection	Electronic	Electronic
Inductive cutoff voltage limited to	-48 V	-48 V
Cable length		
· Unshielded	max. 600 m	600 m
· Shielded	max. 1000 m	1000 m
Current draw		
· Internal (backplane bus)	max. 100 mA	125 mA
· External without load (from +24 V)	typ. 120 mA	200 mA
Power dissipation (nominal operation)	typ. 5 W	6.8 W
Front connector	20-pin	40-pin
Ambient temperature	0 °C ... +60 °C	0 °C ... +60 °C
Transport and storage temperature	-25 °C ... +75 °C	-25 °C ... +75 °C

DEA 300, digital input/output module



Digital input/output modules

Accessories note

Front connectors and preassembled cables are available as accessories (see pages 106-109).



Open-type programmable controllers for use in hazardous locations, Class I, Div. 2 Groups A, B, C, D T4 including Class I Zone 2 IIC.

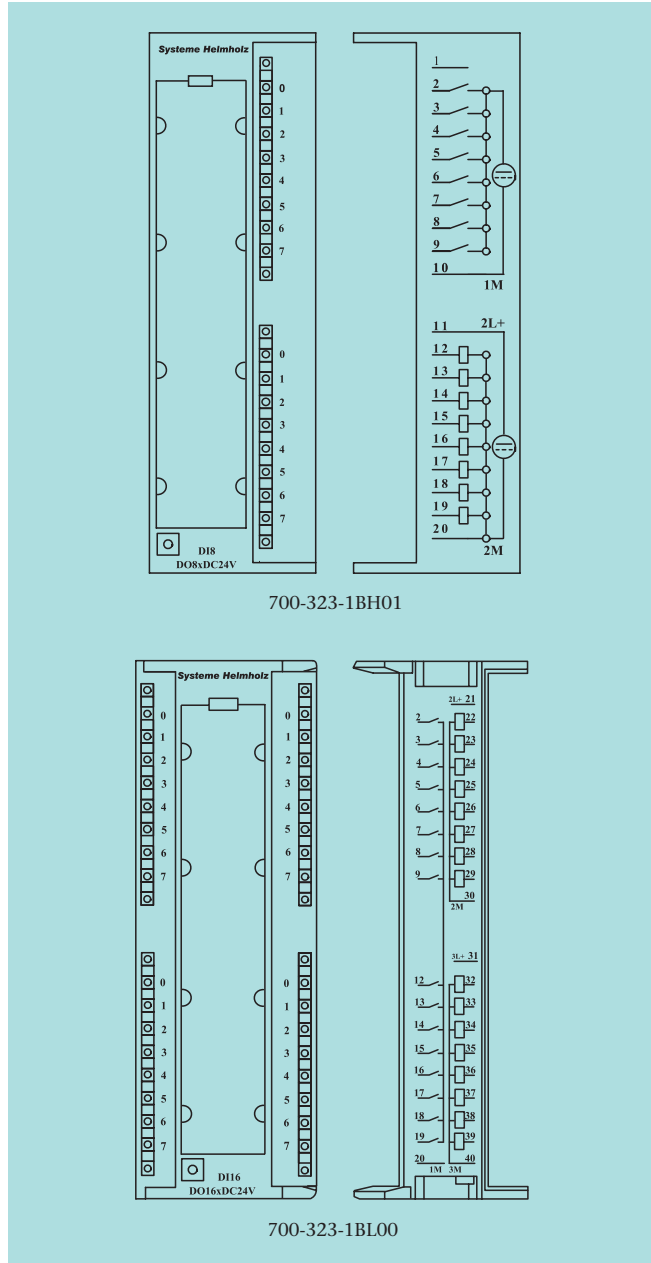

700-323-1BH01

700-323-1BL00

ORDERING DATA

ORDER NO.

DEA 300, digital input/output module 8 inputs (DC 24 V)/ 8 outputs (DC 24 V, 0.5 A)	700-323-1BH01
DEA 300, digital input/output module 16 inputs (DC 24 V)/ 16 outputs (DC 24 V, 0.5 A)	700-323-1BL00
DEA 300 Manual, German/English	900-321-1DE11

TECHNICAL DATA	700-323-1BH01	700-323-1BL00
Number of inputs	8	16
Electrically isolated (from backplane bus) in groups to	Yes (optocoupler) 8	Yes (optocoupler) 16
Input voltage · Rated value · For signal "0" · For signal "1"	DC 24 V -3 ... +5 V +13 ... +30 V	DC 24 V -3 ... +5 V +13 ... +30 V
Input current · For signal "1" typ.	7 mA	7 mA
Delay time typ.	1.2 ... 4.8 ms	1.2 ... 4.8 ms
Can accommodate 2-wire initiator	Yes	Yes
Permitted bias current for signal "0" max.	1.5 mA	1.5 mA
Cable length · Unshielded max. · Shielded max.	600 m 1000 m	600 m 1000 m
Number of outputs	8	16
Electrically isolated (from backplane bus) in groups to	Yes (optocoupler) 8	Yes (optocoupler) 8
Output current · Rated value	0.5 A	0.5 A
Short-circuit protection	Electronic	Electronic
Inductive cutoff voltage limited to	-48 V	-48 V
Cable length · Unshielded max. · Shielded max.	600 m 1000 m	600 m 1000 m
Supply voltage U_p, U_s · Rated value · Ripple U_{rs} max. · Permissible range (with ripple) · Value for $t < 10$ ms max.	DC 24 V 3.6 V 20 ... 30 V 50 V	DC 24 V 3.6 V 20 ... 30 V 50 V
Current draw · Internal (backplane bus) typ. · External without load (from +24 V) max.	55 mA 60 mA	90 mA 120 mA
Power dissipation (nominal operation) typ.	3.5 W	6.8 W
Front connector	20-pin	40-pin
Ambient temperature Transport and storage temperature	0 °C ... +60 °C -25 °C ... +75 °C	0 °C ... +60 °C -25 °C ... +75 °C

DEA 300, digital output module; 2 amperes



Digital output module, 8 outputs, 2 amperes

Accessories note

Front connectors and preassembled cables are available as accessories (see pages 106-109).

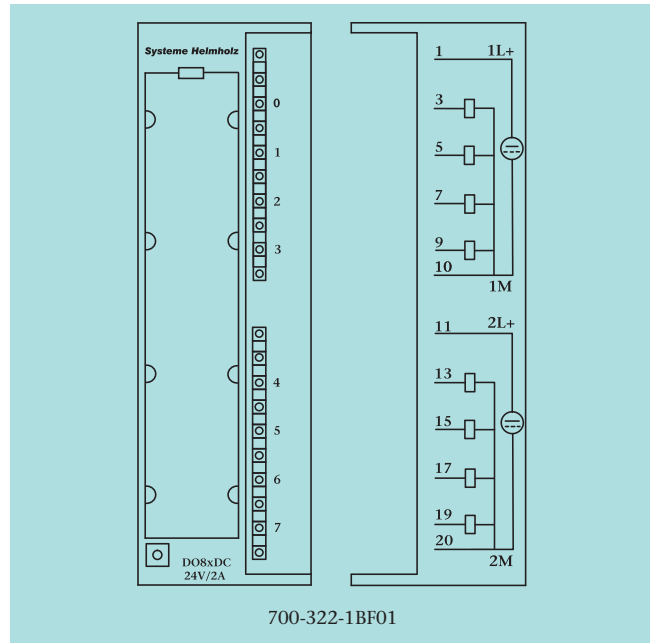
**TECHNICAL DATA**

Number of outputs		8
Electrically isolated (from backplane bus) in groups to		Yes (optocoupler) 4
Supply voltage L+/L-		
· Rated value		DC 24 V
· Ripple U_{SS}	max.	3.6 V
· Permissible range (with ripple)		20 ... 30 V
· Value for $t < 10$ ms	max.	40 V
Output current		
· Rated value		2 A
Total current of the outputs (per group, horizontal configuration)		
· Up to 40 °C		8 A
· Up to 60 °C		6 A
Short-circuit protection		Electronic
Short-circuit current	typ.	12 A clocked
Limitation of inductive cutoff voltage to		-23 V
Cable length		
· Unshielded	max.	600 m
· Shielded	max.	1000 m
Current draw		
· Internal (backplane bus)	typ.	40 mA
· External without load (from +24 V)	max.	60 mA
Power dissipation (nominal operation)	typ.	6.8 W
Front connector		20-pin
Ambient temperature		0 °C ... +60 °C
Transport and storage temperature		-25 °C ... +75 °C

ORDERING DATA**ORDER NO.**

DEA 300, digital output module
8 outputs (DC 24 V, 2 A)

700-322-1BF01

DEA 300 Manual, German/English

900-321-1DE11



Digital output module, 16 relays

Accessories note

Front connectors and preassembled cables are available as accessories (see pages 106-109).



Order No. 700-322-1HH01:

Open-type programmable controllers for use in hazardous locations, Class I, Div. 2 Groups A, B, C, D T6 including Class I Zone 2 IIC.

TECHNICAL DATA

	700-322-1HH01	700-322-1HF01
Number of outputs	16	8
Load voltage L+/L-	DC 24 V	DC 24 V
Output voltage	AC to 230 V DC to 120 V	AC to 230 V DC to 120 V
Output current		
Total current of the outputs (per group) max.	8 A	4 A
Electrically isolated (from backplane bus) in groups to	Yes (optocoupler) 8	Yes (optocoupler) 2
Thermal continuous current	2 A	3 A
Switching frequency of the outputs		
· Under resistive load max.	1 Hz	2 Hz
· Under inductive load max.	0.5 Hz	0.5 Hz
· Under lamp load max.	1 Hz	2 Hz
· Mechanical max.	10 Hz	10 Hz
Switching capacity of the contacts		
· Under resistive load max.	2 A (AC 230 V) 2 A (DC 24 V)	2 A (AC 230 V) 2 A (DC 24 V)
· Under inductive load max.	2 A (AC 120 V) 2 A (DC 24 V)	2 A (AC 120 V) 2 A (DC 24 V)
Operations of the contacts		
· Under mechanical load	10 million	10 million
· Under resistive load	2 A, 1 million	2 A, 0.7 million
Front connector	20-pin	20-pin
Ambient temperature	0 °C ... + 60 °C	0 °C ... +60 °C
Transport and storage temperature	-25 °C ... +75 °C	-25 °C ... +75 °C

ORDERING DATA

ORDERING DATA	ORDER NO.
DEA 300, digital output module	700-322-1HH01
16 outputs, relay, 2 A	700-322-1HF01
8 outputs, relay, 2 A	900-321-1DE11
DEA 300 Manual, German/English	

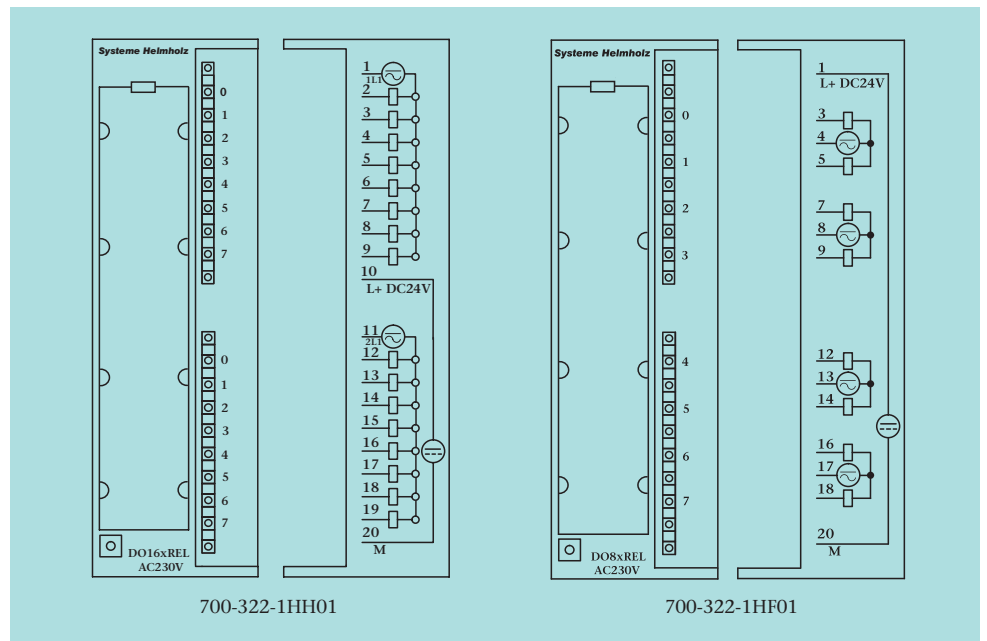

DEA 300, digital output module; relay output, 5 amperes



Digital output module, 8 relays

Accessories note

Front connectors and preassembled cables are available as accessories (see pages 106-109).

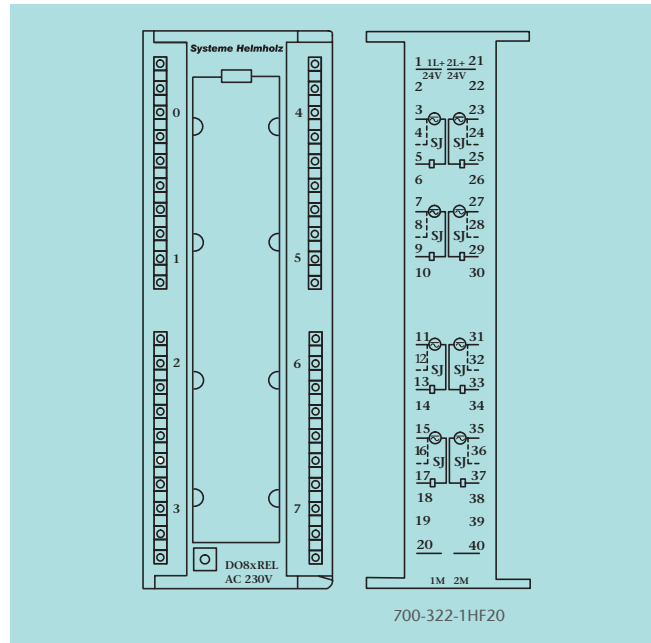
**TECHNICAL DATA**

Number of outputs	8
Load voltage L+/L-	DC 24 V
Output voltage	AC to 230 V DC to 120 V
Output current	
Total current of the outputs (per group) max.	5 A
Electrically isolated (from backplane bus)	Yes (optocoupler)
Switching frequency of the outputs	
· Under resistive load max.	2 Hz
· Under inductive load max.	0.5 Hz
· Under lamp load max.	2 Hz
· Mechanical max.	10 Hz
Switching capacity of the contacts	
· Under resistive load max.	8 A (AC 230 V) 8 A (DC 24 V)
· Under inductive load max.	3 A (AC 230 V) 2 A (DC 24 V)
Switching cycles of the contacts	
· Under mechanical load	10 million
· Under resistive load	5 A, 0.2 million
Front connector	40-pin
Ambient temperature	0 °C ... +60 °C
Transport and storage temperature	-25 °C ... +75 °C

ORDERING DATA**ORDER NO.**

DEA 300, digital output module
8 outputs, relay, 5 A, quenching circuit

700-322-1HF20

DEA 300 Manual, German/English

900-321-1DE11



Digital input module, 120/230 V

Accessories note

Front connectors and preassembled cables are available as accessories (see pages 106-109).



Open-type programmable controllers for use in hazardous locations, Class I, Div. 2 Groups A, B, C, D T4 including Class I Zone 2 IIC.

TECHNICAL DATA

	700-321-1FH00	700-321-1EL00
Number of inputs	16	32
Electrically isolated (from backplane bus) in groups to	Yes (optocoupler) 4	Yes (optocoupler) 8
Input voltage · Rated value (all input voltages must have the same phase) · For signal "0" · For signal "1" · Frequency range	120/230 V AC 0 ... 40 V 79 ... 264 V 47 ... 63 Hz	120 V AC 0 ... 20 V 74 ... 132 V 47 ... 63 Hz
Input current for signal "1" · 120 V, 60 Hz typ. · 230 V, 50 Hz typ.	8 mA 13 mA	22 mA -
Delay time · From "0" to "1" typ. · From "1" to "0" typ.	25 ms 25 ms	15 ms 25 ms
Cable length · Unshielded max. · Shielded max.	600 m 1000 m	600 m 1000 m
Internal current draw typ. Power dissipation of the module typ.	30 mA 4.5 W	16 mA 5.8 W
Front connector	20-pin	40-pin
Ambient temperature Transport and storage temperature	0 °C ... +60 °C -25 °C ... +75 °C	0 °C ... +60 °C -25 °C ... +75 °C

ORDERING DATA

ORDER NO.

DEA 300, digital input module 16 inputs, AC 120 V/230 V 32 inputs, AC 120 V	700-321-1FH00 700-321-1EL00
DEA 300 Manual, German/English	900-321-1DE11

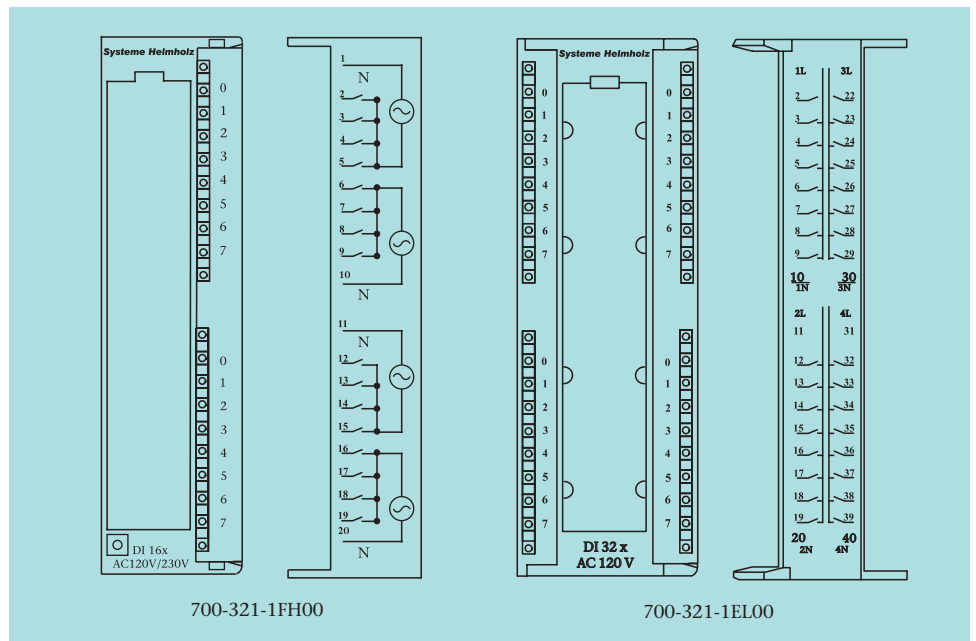

AEA 300, analog input module for connecting current transmitters



Analog input module, current transmitter

The analog input module is suitable for connection of current transmitters in the range up to ± 20 mA. The signal lines are connected to the corresponding front connectors and can be marked in the label field. The modules can be fully parameterized with the hardware configurator of the programming software. A hardware configuration is not necessary (no measuring range module).

Accessories note

Front connectors and preassembled cables are available as accessories (see pages 106-109).



Open-type programmable controllers for use in hazardous locations, Class I, Div. 2 Groups A, B, C, D T6 including Class I Zone 2 IIC.

ORDERING DATA

AEA 300, analog input module
8 current inputs, for connection
of current transmitters, 4–20 mA

AEA 300 Manual, German/English

ORDER NO.

700-331-4MA20

900-331-0AA01

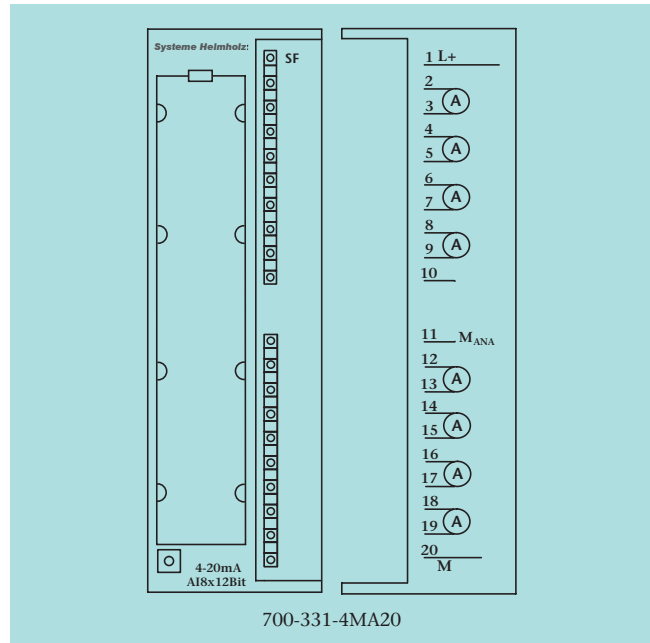
**TECHNICAL DATA**

Number of inputs	8
Alarms	
· Limit alarm	Parameterizable
· Diagnostic alarm	Parameterizable for channels 0 and 2
Diagnostics	Red LED for group error indicator
Load voltage L+/L-	DC 24 V
Reverse polarity protection	Yes
Input ranges	
· Current, 4 DMU	± 3.2 mA/25 Ω ± 10 mA/25 Ω 0 ... 20 mA/25 Ω 4 ... 20 mA/25 Ω ± 20 mA/25 Ω 4 ... 20 mA/25 Ω
· Current, 2 DMU	± 20 mA/25 Ω 4 ... 20 mA/25 Ω
Permissible input current for current input	Max. 40 mA
Electrically isolated from backplane bus	Yes
Conversion time/resolution (per channel)	
· Integration time	2.5/16.6/20/100 ms
· Noise suppression for interference frequency	400/60/50/10 Hz
· Resolution (VZ = sign) (depending on the integration time)	9 + VZ / 12 + VZ / 12 + VZ / 14 + VZ bit
Operational limit	max. ± 0.6 %
Basic error limit at 25 °C	max. ± 0.5 %
Cable length (shielded)	200 m
Current draw	
· Internal (from backplane bus)	typ. 120 mA
· External (L+)	max. 200 mA
Power dissipation	typ. 1.8 W
Front connector	20-pin
Ambient temperature	0 °C ... +60 °C
Transport and storage temperature	-25 °C ... +75 °C



Analog input module, voltage transmitter

The analog input module is suitable for connection of voltage transmitters in the range up to ±10 V. The signal lines are connected to the corresponding front connectors and can be marked in the label field. The modules can be fully parameterized with the hardware configurator of the programming software. A hardware configuration is not necessary (no measuring range module).

Accessories note

Front connectors and preassembled cables are available as accessories (see pages 106-109).



Open-type programmable controllers for use in hazardous locations, Class I, Div. 2 Groups A, B, C, D T6 including Class I Zone 2 IIC.

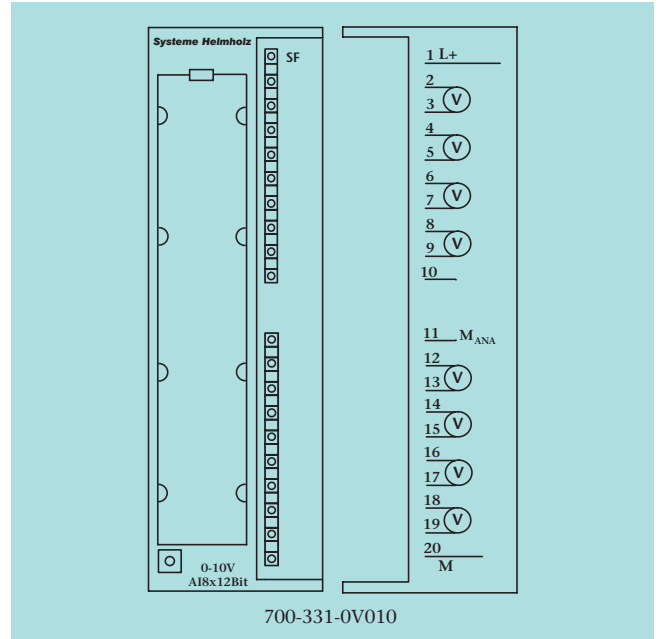

TECHNICAL DATA

Number of inputs	8
Alarms	
· Limit alarm	Parameterizable
· Diagnostic alarm	Parameterizable for channels 0 and 2
Diagnostics	Red LED for group error indicator
Load voltage L+/L-	DC 24 V
Reverse polarity protection	Yes
Input ranges	
Voltage/input resistance	±80 mV/10 M Ω ±250 mV/10 M Ω ±500 mV/10 M Ω ±1 V/10 M Ω ±2.5 V/100 k Ω ±5 V/100 k Ω 1 ... 5 V/100 k Ω ±10 V/100 k Ω
Permissible input voltage for voltage input	max. 20 V
Electrically isolated from backplane bus	Yes
Conversion time / resolution (per channel)	
· Integration time	2.5/16.6/20/100 ms
· Noise suppression for interference frequency	400/60/50/10 Hz
· Resolution (VZ = sign) (depending on the integration time)	9 + VZ / 12 + VZ / 12 + VZ / 14 + VZ bit
Operational limit	max. ±0.6 %
Basic error limit at 25 °C	max. ±0.5 %
Cable length (shielded)	max. 200 m (50 m at ±80 mV)
Current draw	
· Internal (from backplane bus)	typ. 120 mA
· External (L+)	max. 200 mA
Power dissipation	typ. 1.8 W
Front connector	20-pin
Ambient temperature	0 °C ... +60 °C
Transport and storage temperature	-25 °C ... +75 °C

ORDERING DATA

ORDER NO.

AEA 300, analog input module 8 voltage inputs, for connection voltage transmitters, 0–10 V	700-331-0V010
AEA 300 Manual, German/English	900-331-0AA01

AEA 300, analog input module for connecting resistance thermometers



Analog input module, resistance thermometer

The analog input module is suitable for connection of Pt100/ Ni100 sensors and resistors. The signal lines are connected to the corresponding front connectors and can be marked in the label field. The modules can be fully parameterized with the hardware configurator of the programming software. A hardware configuration is not necessary (no measuring range module).

Accessories note

Front connectors and preassembled cables are available as accessories (see pages 106-109).



Open-type programmable controllers for use in hazardous locations, Class I, Div. 2 Groups A, B, C, D T6 including Class I Zone 2 IIC.

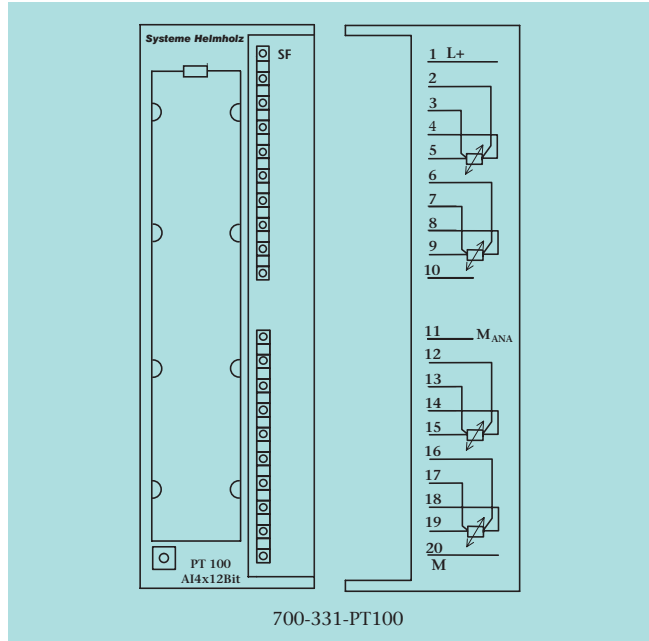

700-331-PT100

TECHNICAL DATA

Number of inputs	4
Alarms · Limit alarm · Diagnostic alarm	Parameterizable Parameterizable for channels 0 and 2
Diagnostics	Red LED for group error indicator
Load voltage L+/L-	DC 24 V
Reverse polarity protection	Yes
Input resistance	10 MΩ
Resistance thermometer	Pt100, Ni100 (Standard and climate range)
Resistance measuring range	150, 300, 600 Ω
Connection of signal sensors	2-, 3-, or 4-wire Connector
Electrically isolated from backplane bus	Yes
Conversion time / resolution (per channel) · Integration time · Noise suppression for interference frequency · Resolution (VZ = sign) (depending on the integration time)	2.5/16.6/20/100 ms 400/60/50/10 Hz 9 + VZ/12 + VZ/12 + VZ/14 + VZ bit
Operational limit	max. ±0.6 %
Basic error limit at 25 °C	max. ±0.5 %
Cable length (shielded)	max. 200 m
Current draw · Internal (from backplane bus) · External (L+)	typ. 120 mA max. 200 mA
Power dissipation	typ. 1.8 W
Front connector	20-pin
Ambient temperature Transport and storage temperature	0 °C ... +60 °C -25 °C ... +75 °C

ORDERING DATA

ORDER NO.

AEA 300, analog input module 4 inputs, Pt100/Ni100 for connection of resistance thermometers	700-331-PT100
AEA 300 Manual, German/English	900-331-0AA01



Analog input module, 8-channel, current transmitter, voltage transmitter, resistors, and resistance thermometers

The analog input module is suitable for connection of current transmitters in the range up to ± 20 mA, voltage transmitters in the range up to ± 10 V, Pt100/Ni100 sensors, and resistors. All inputs can be programmed either as voltage or current inputs for Pt100/Ni100 sensors and resistors, freely selectable in their combination.

The signal lines are connected to the corresponding front connectors and can be marked in the label field. The modules can be fully parameterized with the hardware configurator of the programming software. A hardware configuration is not necessary (no measuring range module).

Accessories note

Front connectors and preassembled cables are available as accessories (see pages 106-109).

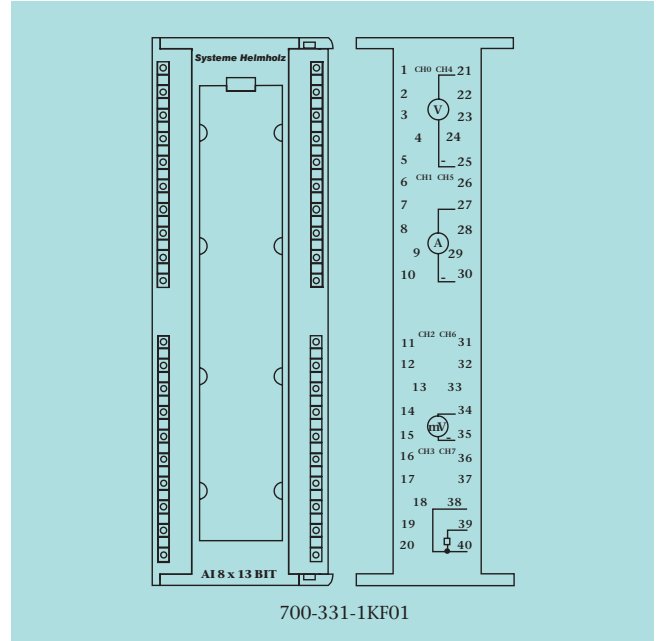

Example assignment

ORDERING DATA

AEA 300, analog input module
8 inputs, for connection of current, voltage transmitters, resistors

AEA 300 Manual, German/English

ORDER NO.

700-331-1KF01

900-331-0AA01

TECHNICAL DATA

Number of inputs	8
Measuring ranges	
· Voltage	± 50 mV, ± 500 mV, ± 1 V, ± 5 V, ± 10 V, 1 ... 5V, 0 ... 10 V
· Current	± 20 mA, 0 ... 20 mA, 4 ... 20 mA
· Resistance	0 ... 6 k Ω , 0 ... 600 Ω
· Resistance thermometer (standard and climate)	Pt100, Ni100, Ni1000, LG-Ni1000
Resolution incl. override range	13 bits
Error limits	
Basic error limit	at 25 °C
· Voltage input	± 0.4 %
· Current input	± 0.4 %
· Resistance	± 0.4 %
· Resistance thermometer	± 0.8 K Pt100 standard, ± 1 K
Operational error limit	In the entire temperature range
· Current input	± 0.6 %
· Resistance	± 0.6 %
· Resistance thermometer	± 1 K; Pt100, Ni100 standard ± 1.2 K
· Voltage input	± 0.6 %
Voltage supply	
Rated voltage	DC 5 V via backplane bus
Current draw	Typ. 160 mA at 5 V (from backplane bus)
Power dissipation	Approx. 0.8 W
Front connector	40-pin
Ambient temperature	0 °C ... +60 °C
Transport and storage temperature	-25 °C ... +75 °C

AEA 300, analog output module; 4-channel



Analog output module, 4-channel

The analog output module is suitable for connection of analog actuators for voltage and current outputs in the range up to ± 10 V or ± 20 mA.

The signal lines are connected to the corresponding front connectors and can be marked in the label field.

The modules are fully configured with the programming software.

Accessories note

Front connectors and preassembled cables are available as accessories (see pages 106-109).

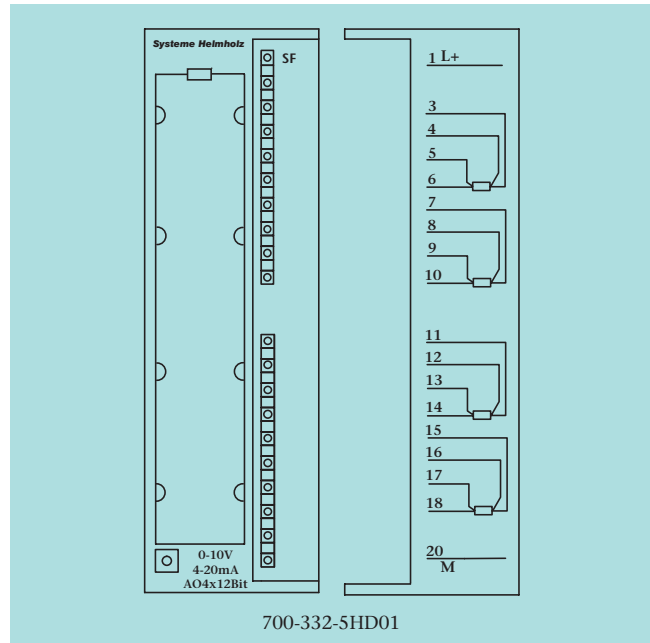

Open-type programmable controllers for use in hazardous locations, Class I, Div. 2 Groups A, B, C, D T6 including Class I Zone 2 IIC.

**TECHNICAL DATA**

Number of outputs	4
Diagnostic alarm	Yes, parameterizable
Diagnostics	Red LED for group error indicator
Load voltage	DC 24 V
Output ranges	
· Voltage outputs	0 ... 10 V; ± 10 V; 1 ... 5 V
· Current outputs	4 ... 20 mA; ± 20 mA; 0 ... 20 mA
Load resistance	
· With voltage outputs	min. 1 k Ω
· With current outputs	max. 500 Ω
· Under capacitive load	max. 1 μ F
· Under inductive load	max. 10 mH
Voltage output	
· Short-circuit protection	Yes
· Short-circuit current	max. 25 mA
Current output	
· No-load voltage	max. 18 V
Electrically isolated from backplane bus	Yes
Operational error limit (0...60 °C, relative to output range)	
· Voltage	± 0.5 %
· Current	± 0.6 %
Basic error limit (Operational limit at 25 °C, relative to output range)	
· Voltage	± 0.4 %
· Current	± 0.5 %
Cable length (shielded)	max. 200 m
Current draw	
· Internal (from backplane bus)	typ. 100 mA
· Externally, without load	max. 240 mA
Power dissipation	typ. 3 W
Front connector	20-pin
Ambient temperature	0 °C ... +60 °C
Transport and storage temperature	-25 °C ... +75 °C

ORDERING DATA**ORDER NO.**

AEA 300, analog output module 4-channel, 4 outputs for connection of analog actuators, 0–10 V/4–20 mA	700-332-5HD01
AEA 300 Manual, German/English	900-331-0AA01



Analog output module, 2-channel

The analog output module is suitable for connection of analog actuators for voltage and current outputs in the range up to ± 10 V or ± 20 mA.

The signal lines are connected to the corresponding front connectors and can be marked in the label field.

The modules are fully configured with the programming software.

Accessories note

Front connectors and preassembled cables are available as accessories (see pages 106-109).



Open-type programmable controllers for use in hazardous locations, Class I, Div. 2 Groups A, B, C, D T6 including Class I Zone 2 IIC.

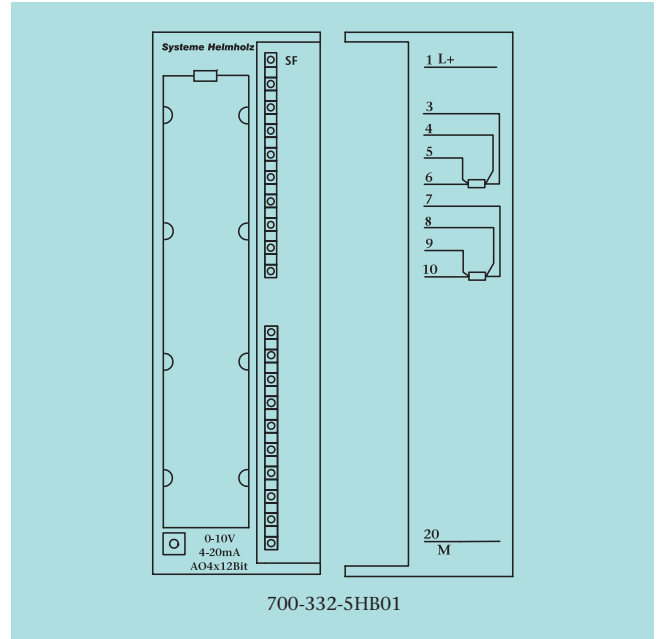

TECHNICAL DATA

Number of outputs	2
Diagnostic alarm	Yes, parameterizable
Diagnostics	Red LED for group error indicator
Load voltage	DC 24 V
Output ranges	
· Voltage outputs	0 ... 10 V; ± 10 V; 1 ... 5 V
· Current outputs	4 ... 20 mA; ± 20 mA; 0 ... 20 mA
Load resistance	
· With voltage outputs	min. 1 k Ω
· With current outputs	max. 500 Ω
· Under capacitive load	max. 1 μ F
· Under inductive load	max. 10 mH
Voltage output	
· Short-circuit protection	Yes
· Short-circuit current	max. 25 mA
Current output	
· No-load voltage	max. 18 V
Electrically isolated from backplane bus	Yes
Operational error limit (0...60 °C, relative to output range)	
· Voltage	± 0.5 %
· Current	± 0.6 %
Basic error limit (Operational limit at 25 °C, relative to output range)	
· Voltage	± 0.4 %
· Current	± 0.5 %
Cable length (shielded)	max. 200 m
Current draw	
· Internal (from backplane bus)	typ. 100 mA
· Externally, without load	max. 240 mA
Power dissipation	typ. 3 W
Front connector	20-pin
Ambient temperature	0 °C ... +60 °C
Transport and storage temperature	-25 °C ... +75 °C

ORDERING DATA

ORDER NO.

AEA 300, analog output module 2-channel, 2 outputs for connection of analog actuators, 0–10 V/4–20 mA	700-332-5HB01
AEA 300 Manual, German/English	900-331-0AA01

Dummymodule



Dummymodule

The dummymodule is suitable for reserving slots for non-parameterized signal modules.

It maintains structure and address assignments for when signal modules are changed out. The dummymodule is available for 20-pin or 40-pin front connectors.

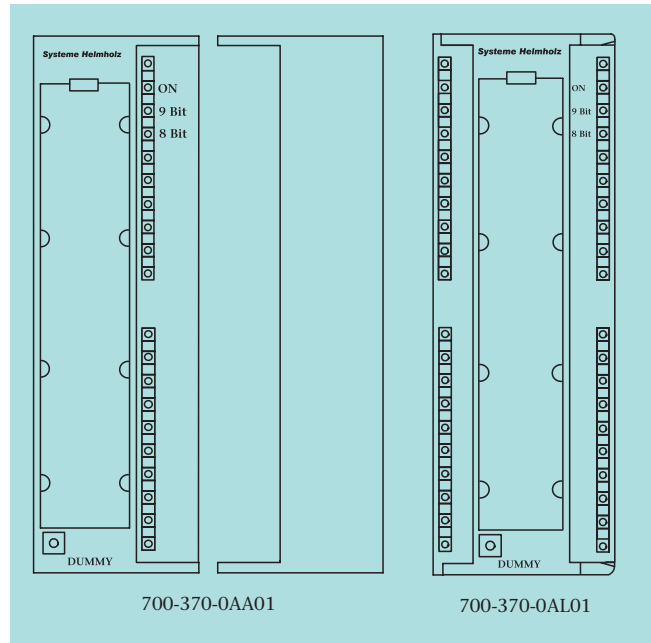

ORDERING DATA

Dummymodule, 20-pin
Dummymodule, 40-pin

DEA 300 Manual, German/English

ORDER NO.

700-370-0AA01
700-370-0AL01

900-321-1DE11

TECHNICAL DATA

Current draw	
Internal	5 mA
Power dissipation (nominal operation) typ.	0.03 W
Front connector	–
Ambient temperature	0 °C ... +60 °C
Transport and storage temperature	-25 °C ... +75 °C



SAS 340, communication module

The SAS 340 is a serial communication module for use in S7-300¹ systems. It allows the connection to the PLC of serial devices such as barcode scanners, operator terminals, serial printers, PCs, PLCs of other manufacturers and supports the protocols ASCII and 3964R.

Serial devices can be connected with RS232 or RS422/RS485. The 9-pin Sub-D socket (15-pin with RS422/485) with standard pin assignment is provided for connecting the partner devices. The additional USB device interface enables the connection of the PLC to PC systems, many of which have no conventional physical port. A virtual COM port driver enables the use of software that expects a COM interface.

The SAS 340 features advanced functions such as support for higher baud rates up to 115 kBaud, making it flexible without any loss of compatibility.

The handling blocks supplied enable simple and flexible integration into the PLC. The module is parameterized in the hardware configurator of the PLC. Advanced functionalities (such as higher baud rates) can be activated easily with the handling blocks.

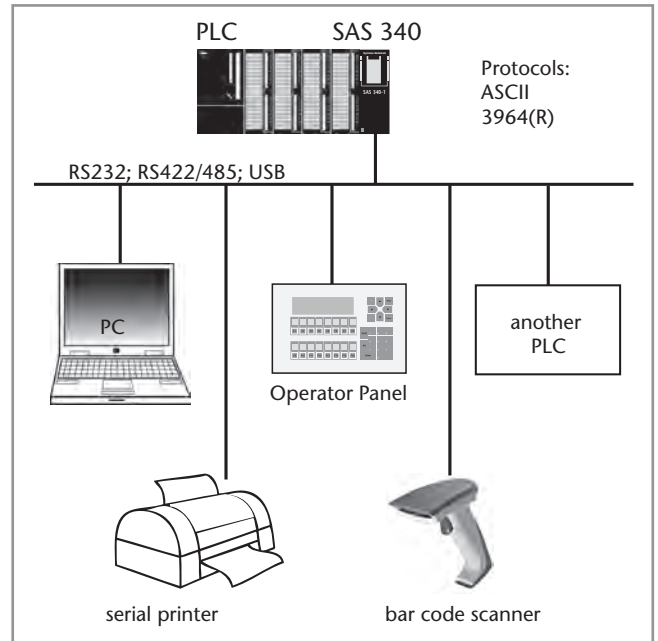

Application example for SAS 340

Note

To enable high integration density in the control cabinet, the SAS 340 is also available with 2 serial interfaces. Both interfaces can be configured independently and used in the PLC.

ORDERING DATA

ORDER NO.

SAS 340-1, 1 x RS232, 1 x USB incl. CD with handling blocks and manual; protocols: ASCII, 3964R	700-340-1AH02
SAS 340-1, 1 x RS422/RS485 incl. CD with handling blocks and manual; protocols: ASCII, 3964R	700-340-1CH02
SAS 340-2, 2 x RS232, 2 x USB incl. CD with handling blocks and manual; protocols: ASCII, 3964R	700-340-2AH02
SAS 340-2, 2 x RS422/RS485 incl. CD with handling blocks and manual; protocols: ASCII, 3964R	700-340-2CH02
SAS 340 Manual, German/English	900-340-1XH02

TECHNICAL DATA

Dimensions in mm (D x W x H)	116 x 40 x 125
Weight	Approx. 280 g
Power supply	
Voltage	DC +5 V via backplane bus
Current draw	typ. 160 mA max. 190 mA
Interface	
Type	V.24 (RS232) RS422/RS485 (X27) USB
Transmission rate	300 Baud ... 115 kBaud
Protocol	ASCII 3964(R)
Connector	Connector, SUB-D, 9-pin; 15-pin (RS422/485)
Status indicator	6 LEDs
Ambient temperature	0 °C ... +60 °C
Transport and storage temperature	-25 °C ... +75 °C

1) S7-300 is a registered trademark of Siemens AG.

SAS 341, serial communication module



SAS 341, communication module

The SAS 341 is a serial communication module for use in S7-300¹ systems. It allows the connection to the PLC of serial devices such as barcode scanners, operator terminals, serial printers, PCs, PLCs of other manufacturers and supports the protocols ASCII, 3964R, and RK512.

Serial devices can be connected with RS232 or RS422/RS485. The 9-pin Sub-D socket (15-pin with RS422/485) with standard pin assignment is provided for connecting the partner devices.

The additional USB device interface enables the connection of the PLC to PC systems, many of which have no conventional physical port. A virtual COM port driver enables the use of software that expects a COM interface.

The SAS 341 features advanced functions such as support for higher baud rates up to 115 kBaud, making it flexible without any loss of compatibility.

The coupling of different PLC types to the S7-300¹ can be flexibly implemented using the standardized RK512 computer coupling protocol.

The handling blocks supplied enable simple and flexible integration into the PLC. The module is parameterized in the hardware configurator of the PLC.

ORDERING DATA

ORDERING DATA	ORDER NO.
SAS 341-1, 1 x RS232, 1 x USB incl. CD with handling blocks and manual; protocols: ASCII, 3964R, RK512, and loadable drivers (MMC)	700-341-1AH02
SAS 341-1, 1 x RS422/RS485 incl. CD with handling blocks and manual; protocols: ASCII, 3964R, RK512, and loadable drivers (MMC)	700-341-1CH02
SAS 341-2, 2 x RS232, 2 x USB incl. CD with handling blocks and manual; protocols: ASCII, 3964R, RK512, and loadable drivers (MMC)	700-341-2AH02
SAS 341-2, 2 x RS422/RS485 incl. CD with handling blocks and manual; protocols: ASCII, 3964R, RK512, and loadable drivers (MMC)	700-341-2CH02
SAS 341 Manual, German/English	900-341-1XH02

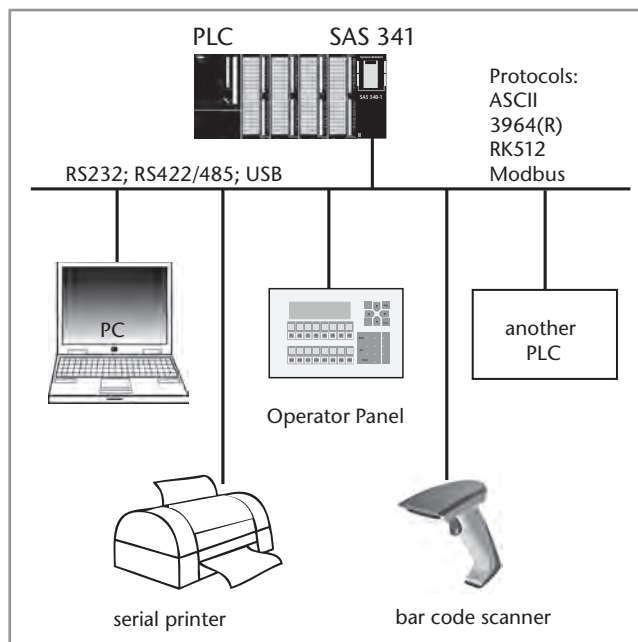

Application example for SAS 341

Note

To enable high integration density in the control cabinet, the SAS 341 is also available with 2 serial interfaces.

Both interfaces can be configured independently and used in the PLC.

Do you need a specific protocol for your device? Ask us!

TECHNICAL DATA

Dimensions in mm (D x W x H)	116 x 40 x 125
Weight	Approx. 280 g
Power supply	
Voltage	DC +5 V via backplane bus
Current draw	typ. 160 mA max. 190 mA
Interface	
Type	V.24 (RS232) RS422/RS485 (X27) USB
Transmission rate	300 Baud ... 115 kBaud
Protocol	ASCII 3964(R) RK512 Modbus master/save
Connector	Connector, SUB-D, 9-pin; 15-pin (RS422/485)
Status indicator	6 LEDs
Ambient temperature	0 °C ... +60 °C
Transport and storage temperature	-25 °C ... +75 °C

1) S7-300 is a registered trademark of Siemens AG.



SAS 341-1 with Modbus RTU driver

The driver add-on “Modbus Master/Slave” enables communication with Modbus RTU-compatible devices. With this driver, the SAS 341 can operate either as a Modbus RTU master or Modbus RTU slave.

The driver is used for the SAS 341-1 with RS232 interface (700-341-1AH02) or for the SAS 341-1 with RS485 interface (700-341-1CH02).

With the RS232 interface, a point-to-point operation is possible, and with the RS485 interface, up to 32 participants can be addressed using the 2-wire half-duplex method.

In the communication with other systems, the Modbus RTU function codes 01, 02, 03, 04, 05, 06, 07, 08, 11, 12, 15, and 16 are supported.

The data exchange with the S7-CPU is in blocks in the supplied function blocks.

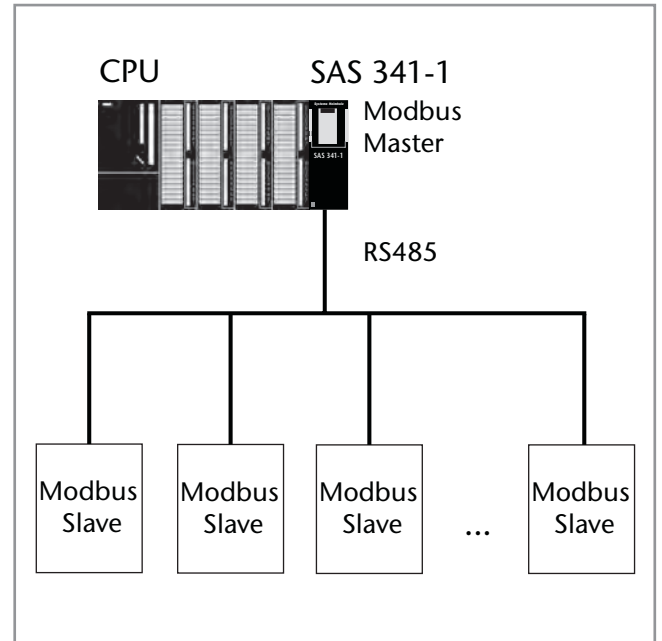

SAS 341-1 as Modbus master

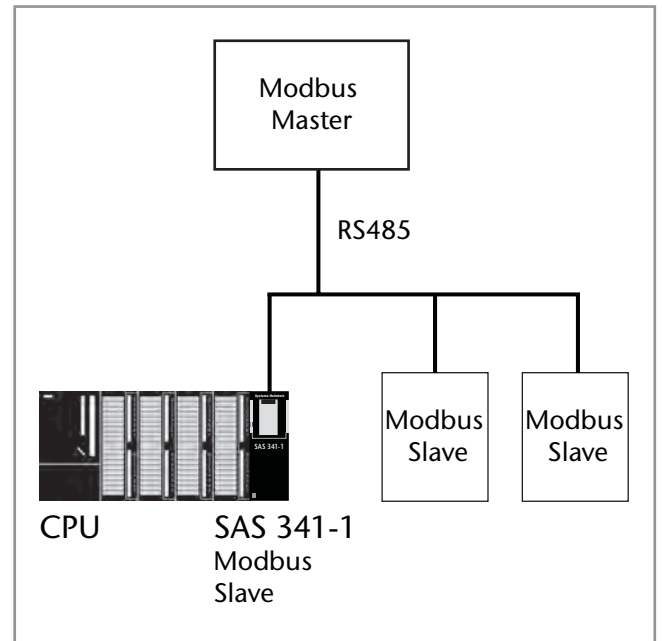

SAS 341-1 as Modbus slave

ORDERING DATA

ORDER NO.

Modbus master/slave driver for SAS 341-1 (on Micro Memory Card, can only be used in SAS 341-1 modules)

800-341-MOD01

SAS 341 Manual, Modbus driver German/English

900-341-MOD01

EIB 300, communication module for twisted-pair EIB/KNX



EIB 300, communication module for twisted-pair EIB/KNX

The EIB 300 is a communication module for use in S7-300¹ systems. It enables the connection of an EIB / KNX bus to the PLC, with the bus being placed directly on the module.

Through the possibilities of PLC programming, complex control and monitoring functions can be easily implemented on the EIB/KNX bus.

In “object mode,” the EIB 300 is an active participant on the EIB/KNX bus with up to 240 objects, with all object types from 1 bit to 4-byte data size being supported.

The current object values in the PLC are mapped in a data block and exchanged with each PLC cycle. In this way the changes on the EIB side are transferred to the PLC, and values changed in the PLC are transferred to the EIB/KNX bus. In addition, “event” and “control flags” allow influence to be taken on the communication behavior in a targeted manner.

The configuration of the EIB 300 is in the PLC as a CP module. The handling blocks included in the scope of delivery enable easy integration of the EIB 300 into the PLC program. The EIB 300 is integrated as a new device in the ETS² software with a supplied sample project. In object mode, objects organized in various profiles can be configured and adapted to the respective application. Six colored LEDs indicate the current operating status of the EIB 300 and the EIB/KNX bus. The built-in USB interface is provided for firmware updates and more in-depth diagnosis.

FEATURES

- Access to the EIB / KNX bus directly from the PLC
- Implementation of complex control and monitoring functions through PLC programming
- Configurable object operation with up to 240 objects
- Easy integration and handling
- ETS²3 and ETS²4 are supported

TECHNICAL DATA

Dimensions in mm (D x W x H)	116 x 40 x 125
Weight	Approx. 280 g
Power supply	
Voltage	DC +5 V via backplane bus
Current draw	typ. 160 mA max. 190 mA
Interface	
Type	Twisted-pair EIB/KNX
Transmission rate	9600 Baud
Protocol	EIB/KNX; up to 240 objects
Connector	2-pin
Status indicator	6 LEDs
Ambient temperature	0 °C ... +60 °C
Transport and storage temperature	-25 °C ... +75 °C

ORDERING DATA

ORDER NO.

EIB 300, communication module
for Twisted Pair-EIB/KNX

700-820-EIB01

EIB 300 Manual, German/English

900-820-EIB01

1) S7-300 is a registered trademark of Siemens AG.

2) ETS is a registered trademark of the KNX Association.

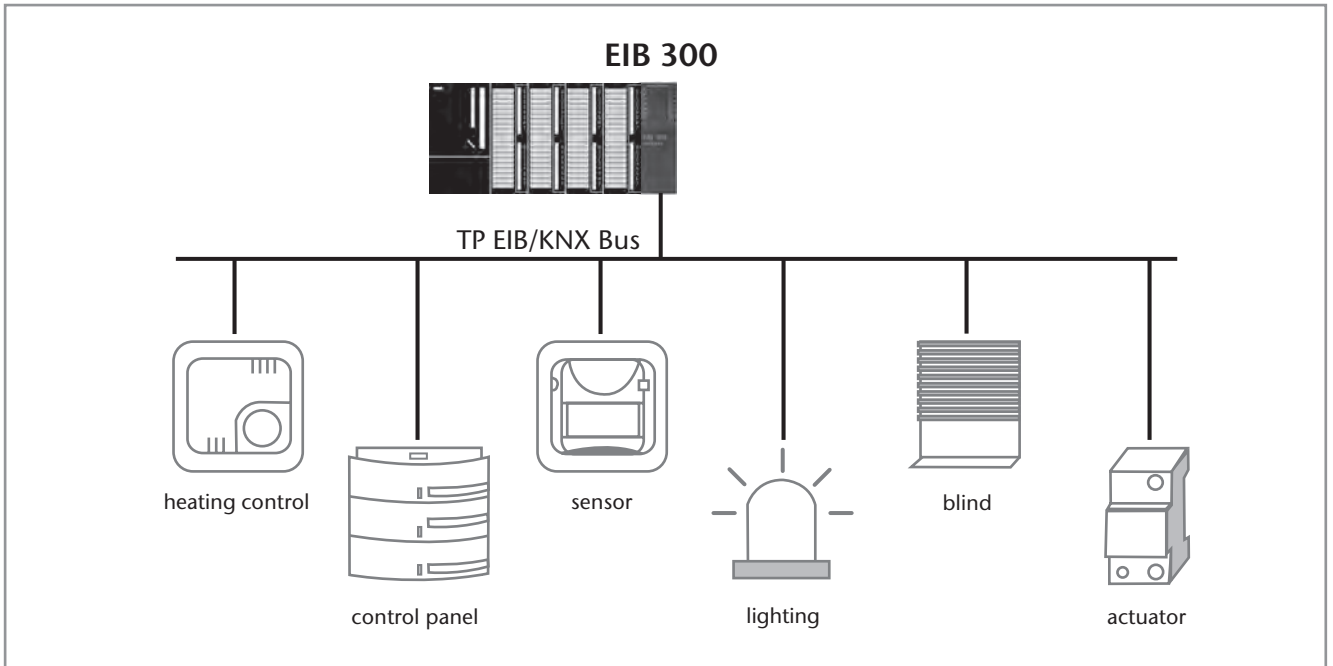

Application example EIB 300

ETS3 - Buildings in Helmholz

File Edit View Commissioning Diagnostics Extras Window Help

Buildings in Helmholz

- PLC cabinet EIB/KNX
 - 1.1.26 Ventilation conference room Analogaktor 4fach
 - 1.1.199 EIB 300 module - Central PLC EIB 300
 - 0: 0 - Tx Object 0
 - 1: 0 - Tx Object 1
 - 2: 0 - Tx Object 2
 - 3: 0 - Tx Object 3
 - 4: 0 - Tx Object 4
 - 5: 0 - Tx Object 5
 - 6: 0 - Tx Object 6
 - 7: 0 - Tx Object 7
 - 8: 0 - Tx Object 8
 - 9: 0 - Tx Object 9
 - 10: 0 - Tx Object 10
 - 11: 0 - Tx Object 11
 - 12: 0 - Tx Object 12
 - 13: 0 - Tx Object 13
 - 14: 0 - Tx Object 14
 - 15: 0 - Tx Object 15
 - 16: 0 - Tx Object 16
 - 17: 0 - Tx Object 17

Number	Name	Object Function	Description	Group Ad...	Length	C	R	W	T	U	Data Typ
209	0	Tx Object 209		13/0/36	2 Byte	C	-	W	T	-	
210	0	Tx Object 210		13/0/69	2 Byte	C	-	W	T	-	
211	0	Tx Object 211		13/1/0	2 Byte	C	-	W	T	-	
212		Rx Object 212	2 Input Bytes @ D8B90-91	1/6/0	2 Byte	C	-	W	T	U	2 byte flo.
213		Rx Object 213	2 Input Bytes @ D8B92-93	1/7/1	2 Byte	C	-	W	T	U	2 byte flo.
214		Rx Object 214	2 Input Bytes @ D8B94-95	1/5/10	2 Byte	C	-	W	T	U	2 byte flo.
215		Rx Object 215	2 Input Bytes @ D8B96-97	1/5/20	2 Byte	C	-	W	T	U	2 byte flo.
216		Rx Object 216	2 Input Bytes @ D8B98-99	4/0/0	2 Byte	C	-	W	T	U	2 byte flo.
217		Rx Object 217	2 Input Bytes @ D8B100-101	4/0/1	2 Byte	C	-	W	T	U	2 byte flo.
218		Rx Object 218	2 Input Bytes @ D8B102-103	4/0/2	2 Byte	C	-	W	T	U	2 byte flo.
219		Rx Object 219	2 Input Bytes @ D8B104-105	4/0/3	2 Byte	C	-	W	T	U	2 byte flo.
220		Rx Object 220	2 Input Bytes @ D8B106-107	4/0/4	2 Byte	C	-	W	T	U	2 byte flo.
221		Rx Object 221	2 Input Bytes @ D8B108-109	4/0/5	2 Byte	C	-	W	T	U	2 byte flo.
222	0	Tx Object 222		4/1/0	3 Byte	C	R	-	-	-	
223	0	Tx Object 223		4/1/1	3 Byte	C	R	-	-	-	
224	0	Tx Object 224		15/1/2	4 Byte	C	-	W	T	-	4 byte flo.
225	0	Tx Object 225		15/1/3	4 Byte	C	-	W	T	-	4 byte sig
226		Rx Object 226	4 Input Bytes @ D8B124-127	15/1/3	4 Byte	C	-	W	T	U	

Group Addresses in Helmholz

Object	Device	Sending	C	R	W	T	U	Product
153: Ausgang 12 - Schalten	1.1.27 Halle HV A1.1 Schalt-/Jalousieaktor 16-/8fach 16A REG		C	R	W	-	-	Schalt-/Jalousieakt
36: Ausgang 2 - Schalten	1.1.44 Halle HV A1.3 Schaltaktor 8fach 16A C-Last REG	S	C	-	W	-	-	Schaltaktor 8fach
62: Ausgang 5 - Schalten	1.1.181 EG UV1 A2.2 Schalt-/Jalousieaktor 8-/4fach 16A REG	S	C	-	W	-	-	Schalt-/Jalousieakt
166: Ausgang 7 - Schalten	1.1.180 EG UV1 A2.1 Schaltaktor 8fach 16A C-Last REG	S	C	-	W	-	-	Schaltaktor 8fach
192: Ausgang 8 - Schalten	1.1.180 EG UV1 A2.1 Schaltaktor 8fach 16A C-Last REG		C	-	W	-	-	Schaltaktor 8fach
36: Ausgang 2 - Schalten	1.1.180 EG UV1 A2.1 Schaltaktor 8fach 16A C-Last REG		C	-	W	-	-	Schaltaktor 8fach
10: Ausgang 1 - Schalten	1.1.173 UV 10G A3.3.1 Schalt-/Jalousieaktor 8-/4fach 16A REG	S	C	-	W	-	-	Schalt-/Jalousieakt
23: Ausgang 2 - Schalten	1.1.174 UV 10G A3.3.1 Schalt-/Jalousieaktor 8-/4fach 16A REG	S	C	-	W	-	-	Schalt-/Jalousieakt
88: Ausgang 7 - Schalten	1.1.174 UV 10G A3.3.1 Schalt-/Jalousieaktor 8-/4fach 16A REG	S	C	-	W	-	-	Schalt-/Jalousieakt
36: Ausgang 3 - Schalten	1.1.173 UV 10G A3.3 Schalt-/Jalousieaktor 8-/4fach 16A REG	S	C	-	W	-	-	Schalt-/Jalousieakt
88: Ausgang 7 - Schalten	1.1.173 UV 10G A3.3 Schalt-/Jalousieaktor 8-/4fach 16A REG	S	C	-	W	-	-	Schalt-/Jalousieakt
101: Ausgang 8 - Schalten	1.1.173 UV 10G A3.3 Schalt-/Jalousieaktor 8-/4fach 16A REG	S	C	-	W	-	-	Schalt-/Jalousieakt
114: Ausgang 9 - Schalten	1.1.170 UV 10G A3.1 Schalt-/Jalousieaktor 16-/8fach 16A REG	S	C	-	W	-	-	Schalt-/Jalousieakt
10: Ausgang 1 - Schalten	1.1.174 UV 10G A3.3.1 Schalt-/Jalousieaktor 8-/4fach 16A REG		C	R	W	-	-	Schalt-/Jalousieakt
10: Ausgang 1 - Schalten	1.1.180 EG UV1 A2.1 Schaltaktor 8fach 16A C-Last REG		C	-	W	-	-	Schaltaktor 8fach
49: Ausgang 4 - Schalten	1.1.174 UV 10G A3.3.1 Schalt-/Jalousieaktor 8-/4fach 16A REG		C	-	W	-	-	Schalt-/Jalousieakt
62: Ausgang 5 - Schalten	1.1.174 UV 10G A3.3.1 Schalt-/Jalousieaktor 8-/4fach 16A REG		C	-	W	-	-	Schalt-/Jalousieakt
75: Ausgang 6 - Schalten	1.1.174 UV 10G A3.3.1 Schalt-/Jalousieaktor 8-/4fach 16A REG		C	-	W	-	-	Schalt-/Jalousieakt

Ready Serial PEI16 - COM1 1.1 0 of 162 selected

Configuration of the EIB 300 in the ETS3

FastPlug, front adapter for S7 modules



FastPlug, front adapter for S7 modules

The FastPlug front adapters are used for screwing and snapping onto 16 or 32-bit S7 input/output modules. The effort required for wiring is very low.

Through the use of pre-assembled system cables, connection errors are excluded. In this way interface modules / transfer modules can be quickly and safely connected to the S7 controller.

The FastPlug front adapters are available in a version for connection to a 16-bit input/output module with a 20-pin ribbon connector, as well as in the version for connection to 32-bit input/output modules with 2 x 20-pin ribbon connectors.



FEATURES

- Front adapter for flat ribbon connector (IDC)
- 20-pin and 40-pin
- Fast, safe, and cost-effective wiring
- Connection errors excluded

ORDERING DATA

ORDERING DATA	ORDER NO.
Front adapter for DEA/AEA 300	
FastPlug 20-way	700-921-1AJ01
FastPlug 40-way	700-921-1AM01
Flat round cable, unshielded, 20-pin, 2 ribbon connectors	
0.5 m	700-923-2BA50
1.0 m	700-923-2BB00
1.5 m	700-923-2BB50
2.0 m	700-923-2BC00
2.5 m	700-923-2BC50
3.0 m	700-923-2BD00
4.0 m	700-923-2BE00
5.0 m	700-923-2BF00

TECHNICAL DATA

Connector type		FastPlug
700-921-1AJ01		1 x 20-pin ribbon connector
700-921-1AM01		2 x 20-pin ribbon connector
Weight		Approx. 50 g
Dimensions (D x W x H mm)		
700-921-1AJ01		131 x 23 x 31
700-921-1AM01		116 x 22 x 30
Voltage		max. 48 V AC/DC between any connections
Current		max. 600 mA per connection
Ambient temperature		0 °C ... +60 °C
Transport and storage temperature		-25 °C ... +80 °C
Relative humidity		max. 75% at +25 °C



Front connector, 20-pin and 40-pin with screw contacts

Front connector with screw contacts

The 20-pin and 40-pin front connector is designed with proven screw contacts.

They enable simple connection of sensors and actuators to input/output modules. In this way the wiring can be kept when replacing modules.

TECHNICAL DATA

20-terminal front connector	
Connector type	screw contacts
Connectable cables With/without ferrules	Flexible, solid 0.25 – 1.5 mm ²
Stripping length	6 mm
Max. tightening torque	0.5 Nm
Weight	Approx. 60 g
Current at 60 °C	3 A
Voltage	230 V AC
Ambient temperature	0 °C ... +60 °C
Transport and storage temperature	-25 °C ... +80 °C
Relative humidity max.	75% at +25 °C
40-terminal front connector	
Connector type	screw contacts
Connectable cables With/without ferrules	Flexible, solid 0.125 – 1.5 mm ²
Stripping length	6–8 mm
Max. tightening torque	0.5 Nm
Weight	Approx. 120 g
Current at 60 °C	3 A
Voltage	230 V AC
Ambient temperature	0 °C ... +60 °C
Transport and storage temperature	-25 °C ... +80 °C
Relative humidity max.	75% at +25 °C

ORDERING DATA**Front connector for DEA/AEA 300**

20-pin with screw contacts
40-pin with screw contacts

ORDER NO.

700-392-1AJ10
700-392-1AM01

Front connector, 40-pin with **EasyConnect®** technology**Front connector with EasyConnect® technology**

The 40-pin front connector is manufactured with the patented **EasyConnect®** technology.

Fast wiring of the plug is ensured through opening and closing of the spring-loaded terminal by turning the screw (180° counterclockwise to open, clockwise to close), saving the user both money and installation time. Ferrules are not necessary. Due to the lower design, the front cover of the module can be optimally closed even in the fully wired state.

TECHNICAL DATA

40-terminal front connector	
Connector type	EasyConnect®
Connectable cables	Flexible cables 0.34 – 1 mm ²
Stripping length	8–10 mm
Weight	Approx. 70 g
Current at 60 °C	3 A
Voltage	230 V AC
Ambient temperature	0 °C ... +60 °C
Transport and storage temperature	-25 °C ... +80 °C
Relative humidity max.	75% at +25 °C

ORDERING DATA**Front connector for DEA/AEA 300**

40-pin with **EasyConnect®** technology

ORDER NO.

700-392-1AM10

Front connector with spring-type terminal, front connector with cables



Front connector, 20-pin and 40-pin with spring-type terminal

Front connector with spring-type terminal

The 20-pin and 40-pin front connectors are designed with installation-friendly spring-type terminal. The front connectors enable simple connection of sensors and actuators to input/output modules. In this way the wiring can be kept when replacing modules.



Front connector with cables

Front connector with cables

The front connectors with cables enable simple connection of sensors and actuators to input/output modules. In this way the wiring can be kept when replacing modules.

TECHNICAL DATA

20-terminal front connector	
Connector type	Spring-type terminal
Connectable cables	Flexible, solid 0.34 – 1.5 mm ²
Stripping length	8 mm
Weight	Approx. 50 g
Current at 60 °C	3 A
Voltage	230 V AC
Ambient temperature	0 °C ... +60 °C
Transport and storage temperature	-25 °C ... +80 °C
Relative humidity max.	75% at +25 °C
40-terminal front connector	
Connector type	Spring-type terminal
Connectable cables	Flexible, solid 0.34 – 1.5 mm ²
Stripping length	8 mm
Weight	Approx. 70 g
Current at 60 °C	3 A
Voltage	230 V AC
Ambient temperature	0 °C ... +60 °C
Transport and storage temperature	-25 °C ... +80 °C
Relative humidity max.	75% at +25 °C

ORDERING DATA

ORDERING DATA	ORDER NO.
Front connector for DEA/AEA 300	
20-pin with spring-type terminal	700-392-1BJ01
40-pin with spring-type terminal	700-392-1BM01

ORDERING DATA

ORDERING DATA	ORDER NO.
Front connector with cables¹ DEA/AEA 300	
with screw contacts, 20-pin, 2 m	700-392-1AJ10A
with screw contacts, 20-pin, 3 m	700-392-1AJ10B
with screw contacts, 20-pin, 5 m	700-392-1AJ10C
Front connector with cables¹ DEA/AEA 300	
for EasyConnect [®] connection, 40-pin, 2 m	700-392-1AM10A
for EasyConnect [®] connection, 40-pin, 3 m	700-392-1AM10B
for EasyConnect [®] connection, 40-pin, 5 m	700-392-1AM10C
Front connector with cables¹ DEA/AEA 300	
for spring-type terminal, 20-pin, 2 m	700-392-1BJ01A
for spring-type terminal, 20-pin, 3 m	700-392-1BJ01B
for spring-type terminal, 20-pin, 5 m	700-392-1BJ01C
Front connector with cables¹ DEA/AEA 300	
for spring-type terminal, 40-pin, 2 m	700-392-1BM01A
for spring-type terminal, 40-pin, 3 m	700-392-1BM01B
for spring-type terminal, 40-pin, 5 m	700-392-1BM01C

1) Wires 0.5 mm², blue (RAL 5010); numbers printed as on connector



Mounting rails

For all modules in the 300 and 1500 series, we offer the mechanical module rack in various prefabricated lengths.



Mounting rail adapter for DIN rail

For all communication modules (such as REX 300, DP/DP coupler, TS 300) designed for mounting on the mounting rail, we offer our mounting rail adapter for DIN rail.

ORDERING DATA

Mounting rail 300 series

- Length 160 mm
- Length 320 mm
- Length 482 mm
- Length 530 mm
- Length 830 mm
- Length 2000 mm

ORDER NO.

- 700-390-1AB60
- 700-390-1SO01
- 700-390-1AE80
- 700-390-1AF30
- 700-390-1AJ30
- 700-390-1BC00

Mounting rail 1500 series

- Length 160 mm
- Length 245 mm
- Length 482 mm
- Length 530 mm
- Length 830 mm
- Length 2000 mm

- 700-590-1AB60
- 700-590-1AC40
- 700-590-1AE80
- 700-590-1AF30
- 700-590-1AJ30
- 700-590-1BC00

ORDERING DATA

Mounting rail adapter for DIN rail

ORDER NO.

700-390-6BA01



Interface converters

Programming adapter
RK512 and HMI adapter
S5 interface converters



SSW7, MPI programming adapter

The SSW7 allows you to connect a PC or laptop with programming software to automation devices via every standard COM interface.

The SSW7 has automatic baud rate detection on the RS232 interface, which makes it possible for it to adapt to the set bit rate (9.6 to 115 kbps).

The MPI interface operates at 187.5 kbps or 19.2 kbps.

The SSW7 is supplied with voltage via the MPI bus from the CPU. With an optional 24 V connection, it can be used anywhere else on the bus line.

With the Speedup tool included in the scope of delivery, the maximum transmission rate of SSW7 can be achieved with any programming software.

Parameterization and diagnostic functions are possible using the SHTools software.

For a firmware update, the latest SHTools version is available for free download on our website www.helmholz.com.

FEATURES

- Programming & visualizing
- Transfer rate up to 115 kbps
- MPI up to 187.5 kbps
- Power supply from the AD or external 24 V

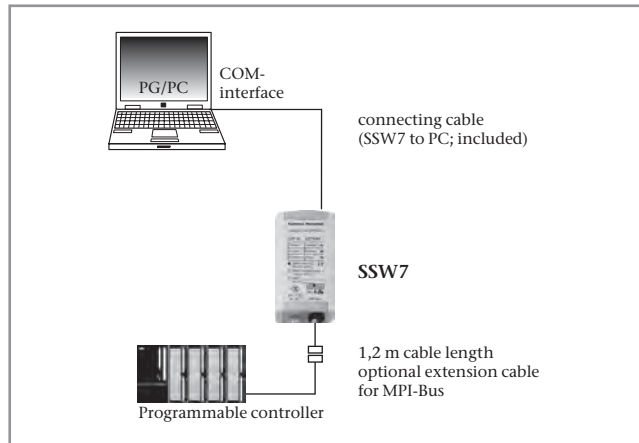

Application example for SSW7

TECHNICAL DATA

Dimensions in mm (D x W x H)	105 x 53 x 29
Weight	Approx. 180 g
Supply voltage	+24 V ±25 % from AD or external
Current draw	typ. 30 mA max. 45 mA
MPI interface	
Type	RS485
Transmission rate	19.2 or 187.5 kbps
Connector	SUB-D, 9-pin
Communication interface	
Type	RS232/RS422
Transmission type	Asynchronous serial
Transmission rate	19.2 kbps ... 115.2 kbps
Parity	Odd
Data format	8 bits
Protocols	PC <-> S7
Connector	Connector, SUB-D, 9-pin
Protection rating	IP 20

ORDERING DATA

ORDER NO.

SSW7, MPI programming adapter, RS232 (incl. 3 m programming cable, manual, CD with software)	700-751-1VK21
SSW7, MPI programming adapter, RS422 (incl. manual and CD with software)	700-752-1VK21
DIN rail adapter, short	700-751-HSH01
24-V power adapter, for SSW7, NETLink®, and REX 300 devices	700-751-SNT01

Starting with STEP¹ 7 version 5.5 SP2, Siemens no longer supports serial COM ports under Windows 7² 64 bit. The TIA Portal¹ also no longer supports any COM ports – regardless of what operating system it is installed on! Our technical sales representatives can provide you with advice on alternatives.

1) STEP and TIA Portal are registered trademarks of Siemens AG.
2) Windows is a registered trademark of the Microsoft Corporation.

SSW7-USB, MPI programming adapter USB



SSW7-USB, MPI programming adapter USB

The SSW7-USB enables conversion from a USB interface to the MPI bus for programming software or visualization.

The SSW7 has a 1.2 m long MPI connecting cable which can be plugged directly into the CPU socket of the automation device and into any other point in an MPI network.

In the housing of the SSW7-USB, there is a USB socket of type "B". The SSW7-USB can be connected to the PC with the USB cable included in the scope of delivery. The SSW7-USB receives its voltage supply from the PC. It can therefore be used at any point on the MPI bus.

A driver for creating a virtual COM port is included. Parameterization and diagnostic functions are possible using the SHTools software.

For a firmware update, the latest SHTools version is available for free download on our website www.helmholz.com.

FEATURES

- Programming & visualization via USB
- MPI up to 187.5 kbps
- Power supply via USB
- Virtual COM port for flexible applications

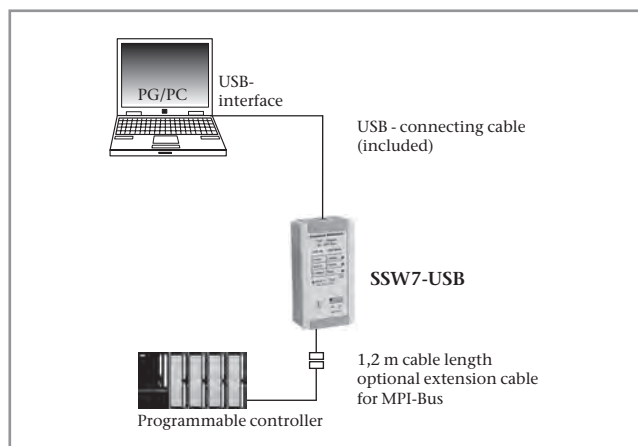

Application example for SSW7-USB

ORDERING DATA

SSW7-USB, MPI programming adapter USB
(incl. 3 m USB cable, manual, CD with software)

DIN rail adapter, short

ORDER NO.

700-755-1VK21

700-751-HSH01

TECHNICAL DATA

Dimensions in mm (D x W x H)	105 x 53 x 29
Weight	Approx. 180 g
Supply voltage	5 V via USB
Current draw	Approx. 150 mA
MPI interface	
Type	RS485
Transmission rate	19.2 or 187.5 kbps
Connector	SUB-D, 9-pin
Communication interface	
Type	USB 1.1
Protocols	PC <-> S7
Connector	USB-B socket
Protection rating	IP 20

Starting with STEP¹ 7 version 5.5 SP2, Siemens no longer supports serial COM ports under Windows 7² 64 bit. The TIA Portal¹ also no longer supports any COM ports – regardless of what operating system it is installed on!

Our technical sales representatives can provide you with advice on alternatives.

- 1) STEP and TIA Portal are registered trademarks of Siemens AG.
- 2) Windows is a registered trademark of the Microsoft Corporation.

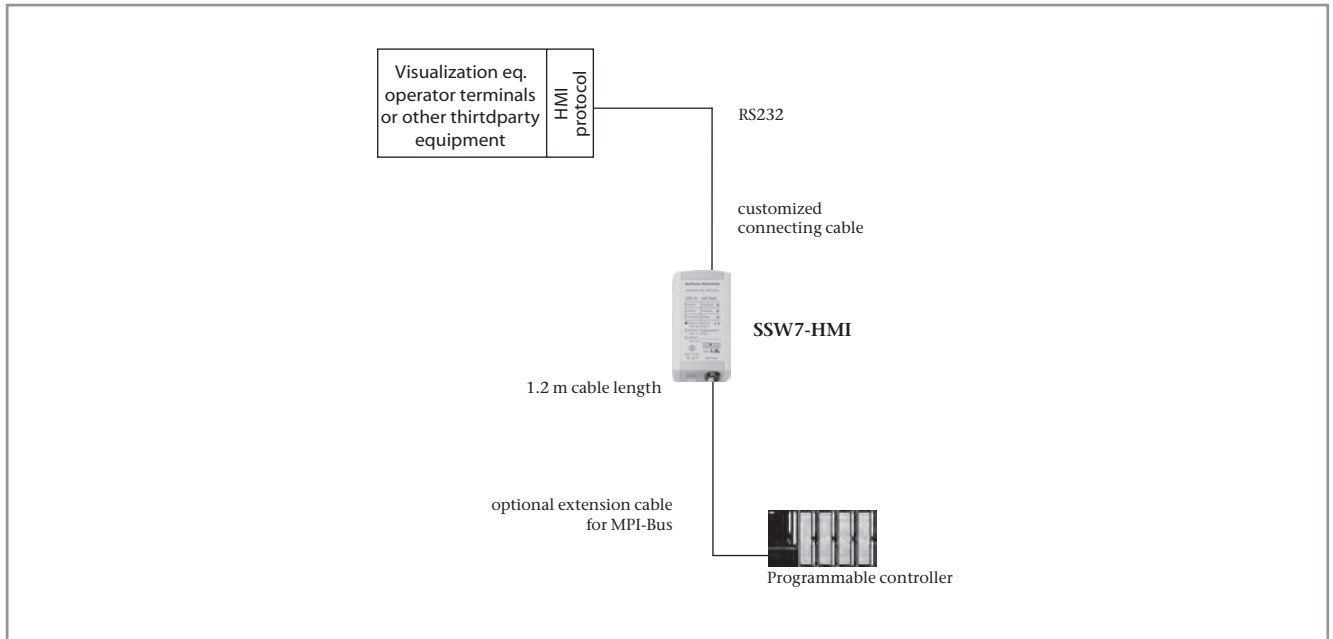

SSW7-HMI

The SSW7-HMI is designed for use with operator terminals, visualizations or other third-party devices that support the HMI protocol from Siemens.

The baud rate of the adapter is set by the protocol (from 4.8 to 115 kbps).

The SSW7-HMI is supplied with voltage via the MPI bus of the CPU. With an optional 24 V connection, it can be used anywhere else in the system.

We provide the SSW7-HMI with an additional programming interface on the connector, including a switchable terminating resistor.

Parameterization and diagnostic functions are possible using the SHTools software.

For a firmware update, the latest SHTools version is available for free download on our website www.helmholz.com.

TECHNICAL DATA

Dimensions (D x W x H mm)	105 x 53 x 29
Weight	Approx. 180 g
Supply voltage (from AD or power supply)	+24 V \pm 25 %
Current draw	Approx. 70 mA
MPI interface	
Type	RS485
Transmission rate	187.5 kbps
Connector	SUB-D, 9-pin with PG interface and terminating resistor
Communication interface	
Type	RS232
Transmission type	Asynchronous serial
Transmission rate	4.8 ... 115.2 kbps
Parity	Odd
Data format	8 bits
Protocols	HMI
Connector	Connector, SUB-D, 9-pin
Protection rating	IP 20

ORDERING DATA

ORDER NO.

SSW7-HMI, MPI-Adapter (incl. manual)	700-751-9VK21
DIN rail adapter , short	700-751-HSH01
24-V power adapter , for SSW7, NETLink®, and REX 300 devices	700-751-SNT01

SSW7-RK512, MPI adapter with RK512 protocol

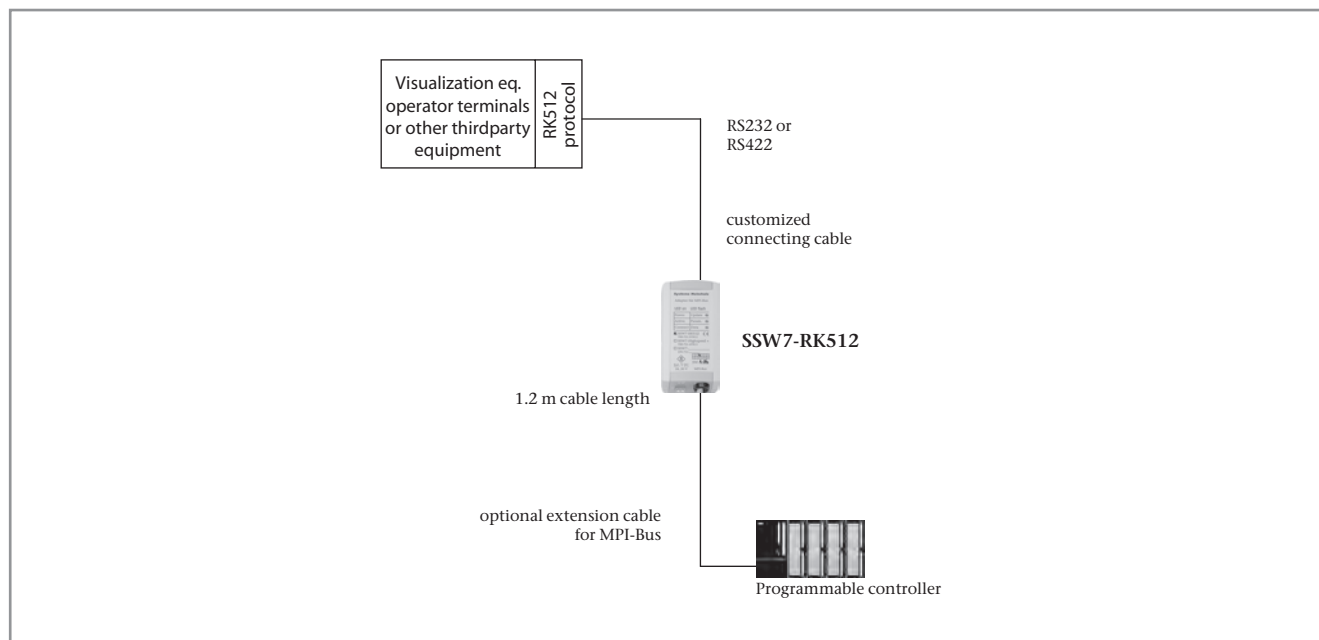

SSW7-RK512

With the SSW7-RK512 it is possible to bring operator terminals, visualization, or other external devices to the S7 without adapting the software, if they support the RK512 protocol.

The SSW7-RK512 transmits data blocks, flags, inputs, and outputs. The MPI settings of the SSW7-RK512 can be changed by a parameterization program or with special RK512 telegrams to connect several SSW7-RK512 units or several ADs to an MPI bus.

The SSW7-RK512 has automatic baud rate detection on the RS232 interface, which makes it possible to adapt to the connected device (from 9.6 to 115 kbps). The MPI interface operates at 187.5 kbps.

The SSW7-RK512 is supplied with voltage via the MPI bus of the CPU. With an optional 24 V connection, it can be used anywhere else in the system.

We provide the SSW7-RK512 with an additional programming interface on the connector, including a switchable terminating resistor. The SSW7-RK512 is also available with RS422 interface. Parameterization and diagnostic functions are possible using the SHTools software.

For a firmware update, the latest SHTools version is available for free download on our website www.helmholz.com.

ORDERING DATA

SSW7-RK512, MPI adapter (incl. manual)

SSW7-RK512, MPI-Adapter with RS422 interface (incl. manual)

DIN rail adapter, short

24-V power adapter, for SSW7, NETLink®, and REX 300 devices

ORDER NO.

700-751-5VK21

700-752-5VK21

700-751-HSH01

700-751-SNT01

TECHNICAL DATA	SSW7-RK512	SSW7-RK512 WITH RS422
Dimensions (D x W x H mm)	105 x 53 x 29	105 x 53 x 29
Weight	Approx. 180 g	Approx. 180 g
Supply voltage (from AD or power supply)	+24 V \pm 25 %	+24 V \pm 25 %
Current draw	Approx. 70 mA	Approx. 70 mA
MPI interface		
Type	RS485	RS485
Transmission rate	19.2 or 187.5 kbps	187.5 kbps
Connector	SUB-D, 9-pin with PG interface and terminating resistor	SUB-D, 9-pin with PG interface and terminating resistor
Communication interface		
Type	RS232	RS422
Transmission type	Asynchronous serial	Asynchronous serial
Transmission rate	19.2 ... 115.2 kbps	19.2 ... 115.2 kbps
Parity	Even	Even
Data format	8 bits	8 bits
Protocols	RK512 with 3964/R	RK512 with 3964/R
Connector	Connector, SUB-D, 9-pin	Connector, SUB-D, 9-pin
Protection rating	IP 20	IP 20



SSW5/LAN, S5 Ethernet converter

The SSW5/LAN is an S5 Ethernet converter which is suitable for programming S5 controllers via Ethernet. A special virtual COM driver enables the use of common programming tools such as STEP 5 V7.2 from Siemens. The power is supplied via the CPU or externally (24 V). A virtual COM port is available for all current commissioning tools.

FEATURES

- Program S5 via TCP/IP
- Virtual COM port for all common commissioning tools
- Power supply from the CPU or external 24 V
- Fits onto any standard S5-CPU
- Unique detection on the network through device names

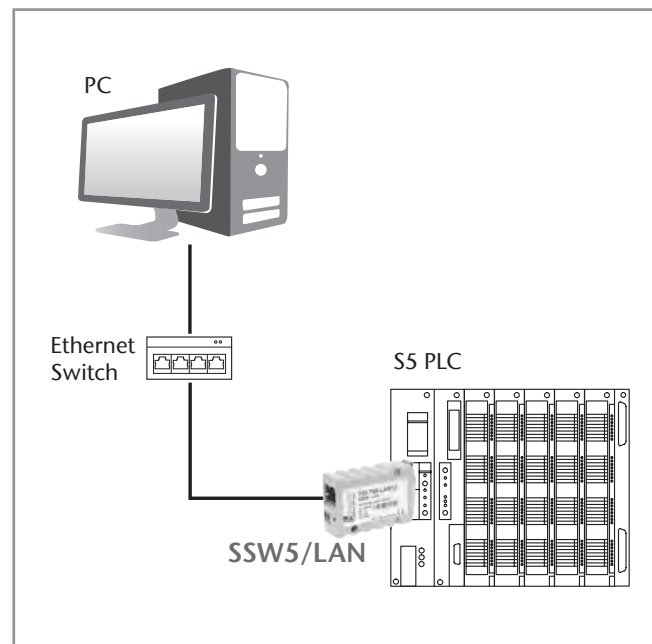

Application example SSW5/LAN

ORDERING DATA

SSW5/LAN, S5 Ethernet converter
(incl. 3 m Ethernet cable, manual, CD with software)

ORDER NO.

700-750-LAN13

TECHNICAL DATA

Dimensions in mm (D x W x H)	65 x 21 x 42
Weight	Approx. 50 g
Power supply	
Voltage	Via AD interface or external
Current draw	typ. Approx. 55 mA
S5 interface	
Type	TTY, 20 mA
Transmission rate	9.6 kBaud
Protocol	AS 511
Connector	Sub-D connector, 15-pin
Ethernet port	
Type	10 Base-T/100 Base-T; RJ45 socket
Transmission rate	10/100 Mbps
Port for device discovery	2362 (UDP)
Port for transmission	2001 (TCP/IP)
Ambient temperature	0 °C ... +60 °C
Transport and storage temperature	-25 °C ... +75 °C
Protection rating	IP 20

1) STEP is a registered trademark of Siemens AG.



SSW5/USB programming cable

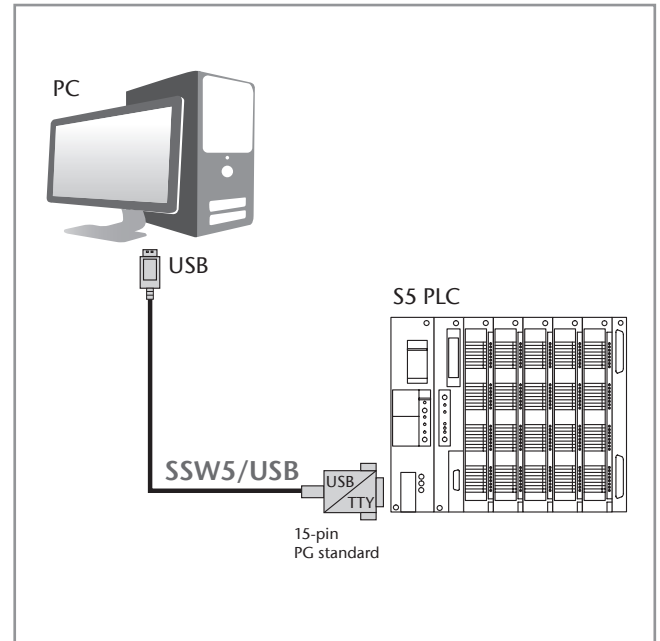

Application example SSW5/USB programming cable

The SSW5/USB programming cable enables a connection between a PC or laptop via USB to an S5 PLC.
A special virtual COM driver enables the use of common programming tools such as STEP¹ 5 V7.2 from Siemens.
The SSW5/USB is equipped with a 15-pin Sub-D connector.

ORDERING DATA

SSW5/USB, S5-USB programming cable 3 m
(incl. manual, CD with software)

ORDER NO.

700-750-0US13

SSW5/USB, S5-USB programming cable 5 m
(incl. manual, CD with software)

700-750-1US13

TECHNICAL DATA

Conversion Interface	USB to TTY USB
Transmission	USB
TTY interface	SUB-D connector, 15-pin
Max. transfer rate	38400 bps
Max. cable length	5 m
Tapping of the supply voltage	On the USB side

1) STEP is a registered trademark of Siemens AG.

SSW3, interface converter cable

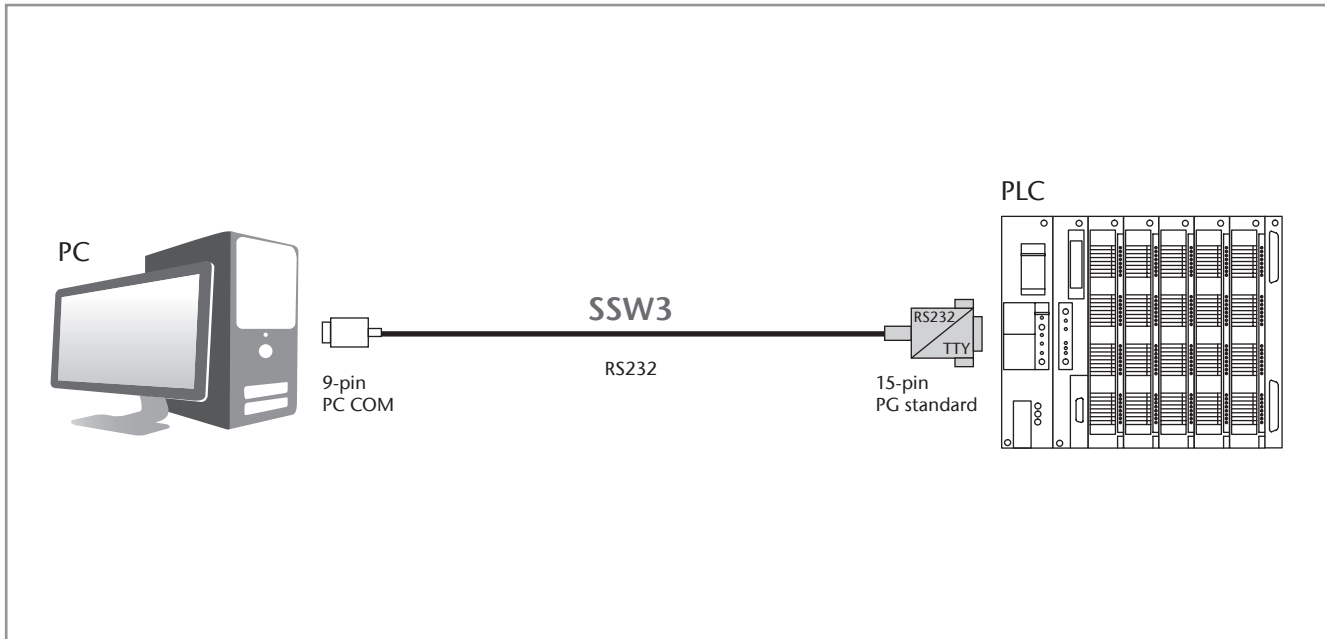

SSW3, interface converter cable

The SSW3 interface converter cable enables a connection between a PC and a PLC.

The RS232/TTY converter is completely integrated into the 15-pin connector housing; an external power supply is therefore not required. The transmission of data signals is over an RS232 connection.

Use in conjunction with:

- Every programming software on a PC
- Online linking to the AD with data exchange
- Visualization and linking software

ORDERING DATA

	ORDER NO.
SSW3, interface converter cable (RS232/TTY), length 5 m	700-750-0AA13
SSW3, interface converter cable (RS232/TTY), length 10 m	700-750-1AA13
SSW3, interface converter cable (RS232/TTY), length 15 m	700-750-2AA13

TECHNICAL DATA

Conversion	RS232 to TTY
Transmission	RS232
RS232 interface	SUB-D socket, 9-pin
TTY interface	SUB-D connector, 15-pin
Max. transmission rate	38400 bps
Max. cable length	15 m
Tapping of the supply voltage	On the AD side



Service

Product training

User workshops

National and international contacts

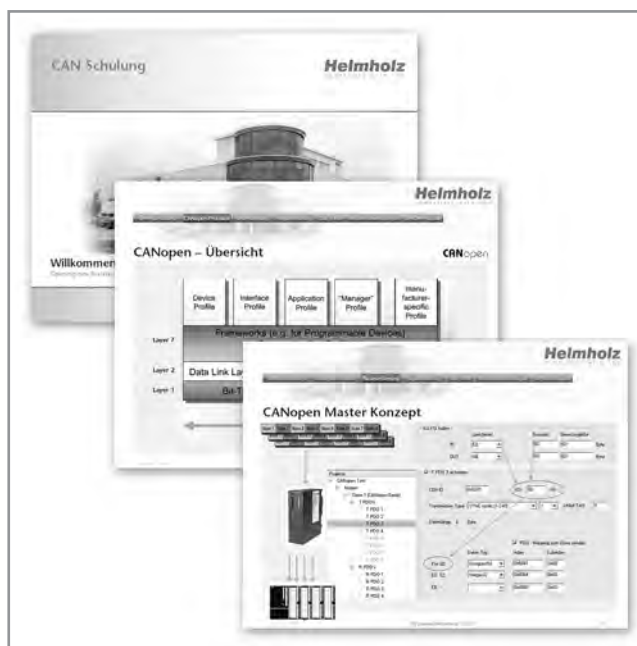

Helmholtz also offers product training courses if required: In our product training, we teach you all you need to know about correct handling of products using practical examples. Our consultants are available by appointment to advise you in detail.

The training takes place in Großensee in the main building. On-site training is also possible. Please request an individual quote for this.

Contents of a CAN training course:

- CAN concept
- CAN Layer 2 protocol
- CANopen® protocol
- SAE J1939 protocol
- CAN 300/CAN 400 parameterization & commissioning
- CAN 300/CAN 400 programming in STEP¹ 7
- DP/CAN coupler

ORDERING DATA

CAN training
CAN/CANopen®/CAN products,
1 day, per participant

ORDER NO.

400-600-CAN01

1) STEP is a registered trademark of Siemens AG.



YOU WANT ...

- to carry out remote maintenance independently of the modem?
- fast remote maintenance?
- remote maintenance of Ethernet devices?
- high availability?

Then take part in one of our user workshops!

In our user workshops on the topic of Ethernet routers, find out which requirements are necessary for Internet remote maintenance, what problems must be considered, and how to deal with them.

For optimal learning of the course content, you will configure a remote maintenance connection yourself on a test setup. The workshops take place in Großensee in the main building. On-site workshops are also possible. Please request an individual quote for this.

Objective

As a participant, you will be trained on the following topics in a practical manner:

REX 100

- Commissioning
- CTM (Configuration Transfer Manager)
- Applications
- WEB2go

VPN portal myREX24

- Opportunities / benefits
- Performing remote maintenance

REX 300

- MPI/PROFIBUS devices
- Usage without VPN portal
- Advanced parameterization
- Reach serial devices

Your advantages

- Small groups with a maximum of three participants per test setup
- Theoretical and practical knowledge in one workshop



Headquarters

Systeme Helmholz GmbH
 Hannberger Weg 2
 91091 Großeneseebach
 Tel.: +49 (91 35) 73 80-0
 Fax: +49 (91 35) 73 80-490
 vertrieb@helmholz.de

Northern Germany Sales

Fabian Slowakiewicz
 Systeme Helmholz GmbH
 Hannberger Weg 2
 91091 Großeneseebach
 Tel.: +49 (91 35) 73 80-0
 Fax: +49 (91 35) 73 80-490
 fabian.slowakiewicz@helmholz.de

Eastern Germany Sales

Siegfried Renner
 B-S-K Industrievertretungen
 Holzmühlenstrasse 4
 09212 Limbach-Oberfrohna
 Tel.: +49 (376 09) 583 55
 Fax: +49 (376 09) 583 56
 siegfried.renner@helmholz.de

Western Germany Sales

Martin Güll
 Systeme Helmholz GmbH
 Hannberger Weg 2
 91091 Großeneseebach
 Tel.: +49 (91 35) 73 80-0
 Fax: +49 (91 35) 73 80-490
 martin.guell@helmholz.de

H-I Elektronik Vertrieb GmbH

Düsseldorfer Straße 547
 47055 Duisburg
 Thomas Dohmen
 Stephan Schmücker
 Tel.: +49 (203) 76 14 03
 Fax: +49 (203) 76 44 00
 vertrieb@h-i-elektronik.de
 www.h-i-elektronik.de

Baden-Württemberg Sales

Markus Wallau
 Systeme Helmholz GmbH
 Hannberger Weg 2
 91091 Großeneseebach
 Tel.: +49 (91 35) 73 80-0
 Fax: +49 (91 35) 73 80-490
 markus.wallau@helmholz.de

Northern Bavaria Sales

Martin Fröhlich
 Systeme Helmholz GmbH
 Hannberger Weg 2
 91091 Großeneseebach
 Tel.: +49 (91 35) 73 80-0
 Fax: +49 (91 35) 73 80-490
 martin.froehlich@helmholz.de

Southern Bavaria Sales

Manfred Spitzer
 Systeme Helmholz GmbH
 Hannberger Weg 2
 91091 Großeneseebach
 Tel.: +49 (91 35) 73 80-0
 Fax: +49 (91 35) 73 80-490
 manfred.spitzer@helmholz.de



SYSTEME HELMHOLTZ GMBH IS REPRESENTED IN THE FOLLOWING COUNTRIES:

Argentina	Mexico
Australia	Netherlands
Austria	Norway
Belgium	Peru
Brazil	Philippines
Bulgaria	Poland
Chile	Portugal
China	Romania
Croatia	Russia
Czech Republic	Saudi Arabia
Denmark	Singapore
Estonia	Slovakia
Finland	Slovenia
France	South Korea
Germany	South Africa
Hungary	Spain
Great Britain (UK)	Sweden
India	Switzerland
Ireland	Taiwan
Italy	Thailand
Japan	Tunisia
Latvia	Turkey
Lebanon	The United Arab Emirates
Lithuania	The United States of America
Luxembourg	Vietnam
Malaysia	

For our resellers contact addresses, please visit us at www.helmholtz.com.

