

Relays and Optocouplers

Application Overview

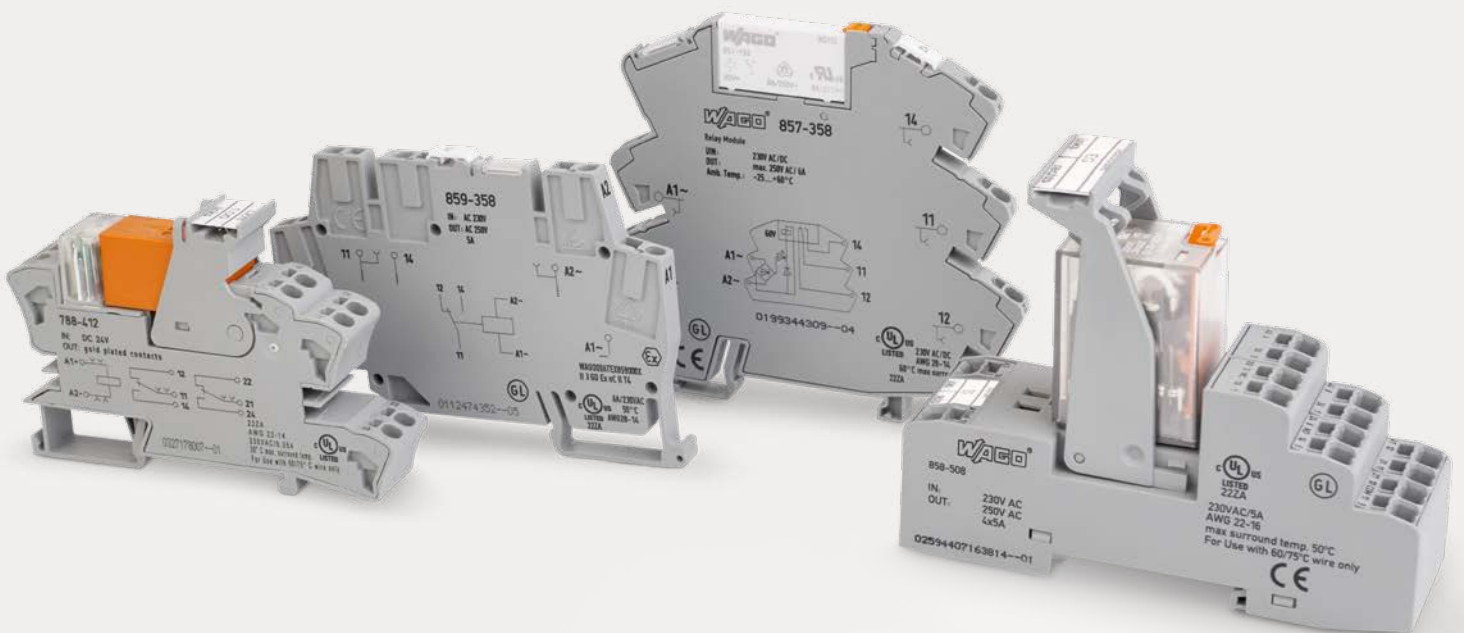

Table of Contents

Features and Advantages	4
Selection Criteria for Relays	6
Long Cables and 2-Wire Sensors	8
Modern Lighting with Electronic Control Gear	10
Functional Safety	12
The Contact Material Is Crucial	14
Relays with Manual Operation	18
Relays with a Wide Input Voltage Range	20
Rail-Specific Requirements	22
Switching DC Loads	26
Optocouplers and Solid-State Relays	28
Glossary	32
Connection Technology	35



iStock.com/ lagereek

FEATURES AND ADVANTAGES

Relays / Optocouplers

Relay or Optocoupler?

Relay	Optocoupler/Solid-State Relay
	<ul style="list-style-type: none"> • Electrically isolate input and output circuits • Adjust different signal levels • Amplify and/or multiply signals
Immunity to electromagnetic interference and transient voltages	Long service life – no mechanical wear on contacts
High, short-term overload on both input and output sides without losing functionality	High switching frequency due to short switch-on and switch-off times
Minimal switching loss/high switching power	Unfazed by shock and vibration
A single module switches both direct and alternating current (highly versatile)	No contact bouncing
No leakage current in the load circuit (air insulation)	“Noiseless” switching
Multiple contacts possible (control signal switches multiple load circuits)	Low control power
Switching state is partially visible to the naked eye	Short response times
Safe isolation between coil and contact set	No electromagnetic radiation from switching sparks or coils – no interference with adjacent modules or electronic components during switching

Read about “Relays” on page 6

Read about “Optocoupler and SSR modules” on page 28



©leungchopan/Fotolia.com

Distinguishing between Optocoupler and Solid-State Relay

Optocoupler	Solid-State Relay
Mounted or soldered to the PCB - Not replaceable	Pluggable on socket - Can be replaced in case of repair
A large number of variants enhances application flexibility and range	Seamless change from electronic to electromechanic switching element

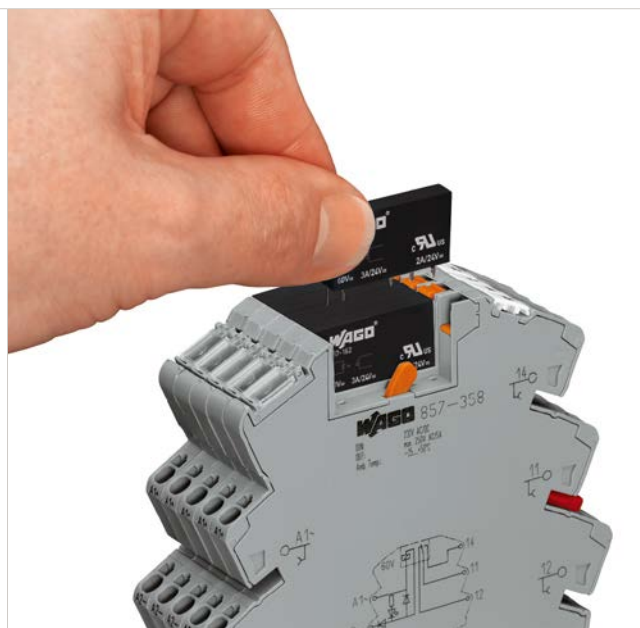

SELECTION CRITERIA FOR RELAYS

It's in the Details

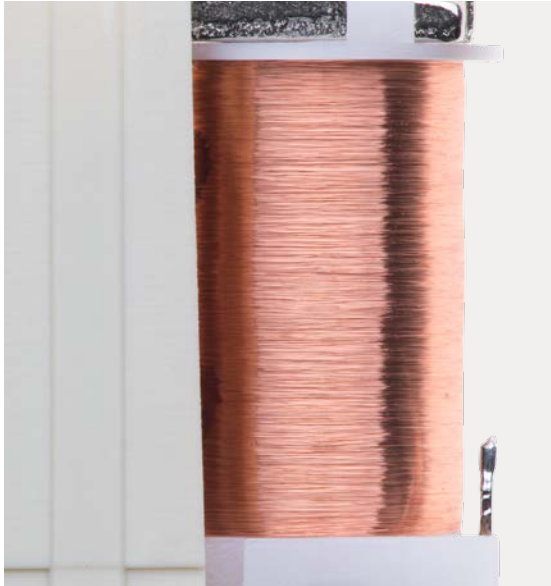

1) Coil

Coil voltage; maximum continuous voltage; response voltage and pick-up current; drop-off voltage and dropout current



2) Contacts

Contact arrangement; contact loading; contact material; service life; contact resistance; isolation requirements; limiting continuous current

In industrial applications, relays are proven interface modules that can handle a variety of tasks. However, some points must be considered when selecting the right relay module. These points include the nominal voltage of the coil, as well as the number of relay break contacts, make contacts and changeover contacts. The contacts are important for the service life. The contact material has to be selected depending on whether inductive, capacitive or resistive loads will be connected.

This application overview provides important information for selecting relays.

5) Other criteria

Ambient temperature;
dielectric strength;
mounting conditions,
IP degree of protection;
approvals



©Friedberg/Fotolia.com



3) Switching time
Response time; drop-out time;
switching frequency; bounce time

4) Mechanical properties
Vibration resistance; shock resistance;
size and space

iStock.com/Bartosz Hadyniak

©Netzer Johannes/Fotolia.com



LONG CABLES AND 2-WIRE SENSORS

Reliably Switch despite Coupling

To switch on, relay modules require the nominal voltage U_N . For operation, however, the holding voltage at only 15 % of the nominal voltage is sufficient. In standard circuits, all relay modules operate reliably. In circuits with long, parallel lines, in circuits with active 2-wire sensors or with digital AC control outputs, however, a low holding voltage often leads to malfunction. The modules no longer switch off. This effect often occurs when updating systems, changing old "power-hungry" to current "power-saving" relay modules.

What are the causes and how can they be solved? Long, parallel lines are capacitively coupled to each other. Energy is then transferred to an adjacent conductor. Active 2-wire sensors, such as proximity switches or level monitors, normally require a minimum continuous current to ensure that the holding voltage is maintained on the relay control lines. Because of this behavior, the relay cannot switch correctly.

For such applications, WAGO has developed specific RC base load modules against interference coupling and integrated them into the relay modules. The modules minimize the unwanted voltages at low loss and allow defined switching.

Application example, triac outputs from controllers

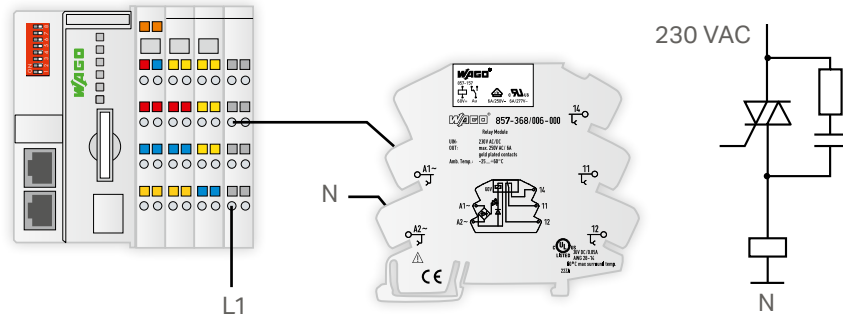

Reliability 24/7: WAGO's sockets that have a miniature switching relay and base load module ensure safety and dependability at voltage levels below an application's release voltage.

©kawinnings/Fotolia.com



Application example, line capacity (level measurement)

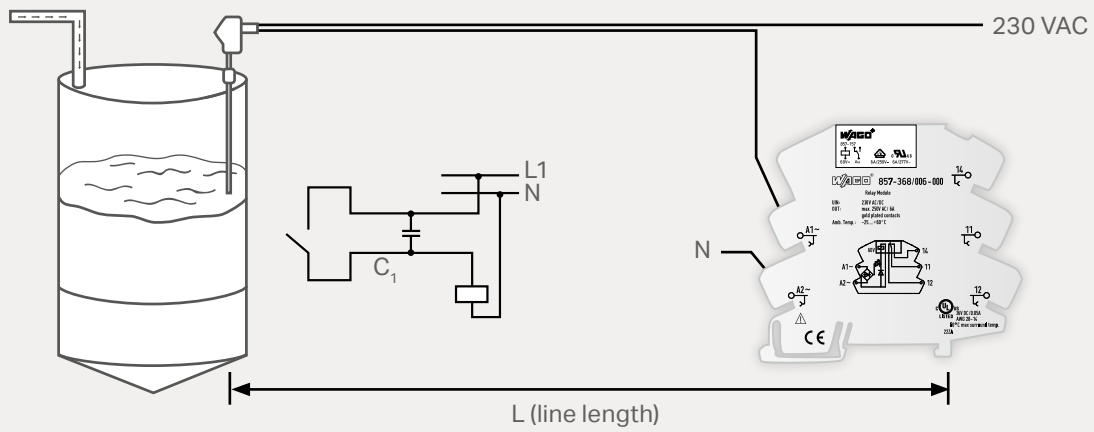

Application example, 2-line sensors (parcel load detection)

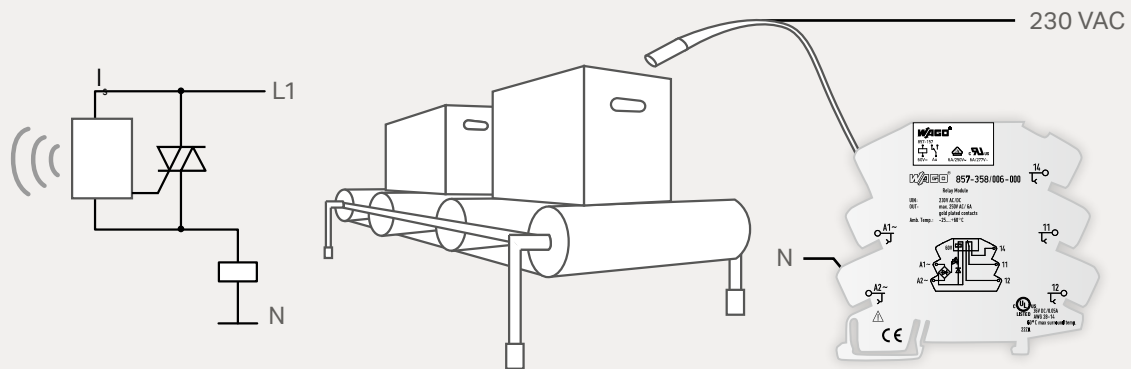

	Description	Item No.	Nominal Input Voltage V_N	Limiting Continuous Current
	Relay module with 1 changeover contact, with integrated base load module	857-358/006-000	230 VAC	6 A
	Relay module with 1 changeover contact, with integrated base load module and gold contacts	857-368/006-000	230 VAC	6 A*

* To prevent the gold layer from being damaged, 30 VDC switching voltages and 50 mA currents shall not be exceeded. Higher switching power eventually evaporates the gold layer. The resulting deposits in the housing may reduce the service life.



MODERN LIGHTING WITH ELECTRONIC CONTROL GEAR

Brief Current Peaks – Fatal Consequences

Equipped with electronic control gear (ECG), modern lights offer numerous advantages. They generate flicker-free light with high levels of efficiency. Both in planning new and replacing old lighting systems, the inrush current of the ECG must be a central focus.

A capacitor in the input circuit of many ECGs causes a substantial current peak when switched on that can exceed far more than ten times the nominal current. Even if the current lasts for just a few milliseconds, it can cause the relay contacts to fuse together.

What should be considered when planning lighting systems?

When selecting relays, the inrush current must absolutely be considered. Standard relays quickly reach their limits. For such applications, WAGO has developed relay modules with contacts that safely control brief high peak inrush currents. The contact material reliably prevents the contacts from catching or fusing.

For maximum inrush currents, relay modules with two contacts working in parallel are available. The first contact consisting of high-strength tungsten catches the current peak. The second contact consisting of highly conductive silver alloy manages the operational current.









As an alternative to relays, the WAGO product portfolio includes optocouplers and solid-state relays for use with capacitive loads. Special designs with zero voltage switches minimize the peaks.

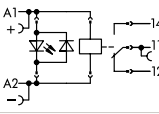

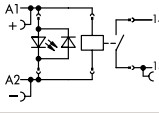
When switching on lamps, substantial current peaks briefly occur. The unwanted effect of wear and contact erosion can be prevented by lamp load relays.

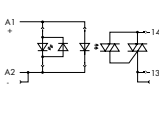
©panthermedia.net/scanrail

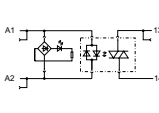
Relay Selection for Lamp Loads

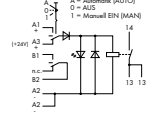
	Description	Item No.	Nominal Input Voltage V_N	Limiting Continuous Current
 	Relay module with 1 changeover contact and status indication, max. inrush current 120 A / 50 ms	788-354	24 VDC	16 A
 	Relay module with 1 make contact and status indication, max. inrush current 165 A / 20 ms	788-357	24 VDC	16 A
 	Solid-state relay module, zero voltage switch	788-720	24 VDC	1 A
 	Solid-state relay module, zero voltage switch	788-721	24 V AC/DC	4 A
 	Relay with 1 make contact, Manual/OFF/Auto switch with feedback contact	789-324	24 VDC	16 A



Signal monitoring: Relays with force-guided contacts make it possible to quickly detect errors such as opening failures.

iStock.com/Richard Clark

FUNCTIONAL SAFETY

Detect Errors in Safety-Related Circuits

To comply with relevant policies and regulations for functional safety, the use of special components is compulsory. These components must meet strict requirements. For relay modules, force-guided contacts with at least one break contact and make contact are required. They must be connected mechanically so that break contacts and make contacts cannot be closed or opened at the same time. This allows errors due to opening failures to be clearly identified. Only errors due to opening and isolation failures are of importance in safety-related matters. In a circuit, an open break contact can be detected by a closed break contact. The same applies to a closed make contact when the break contact is open. Of course, EN 50205 requirements also apply to relays with changeover contacts in safety-related circuits. It stipulates that per changeover contact, only the break contact or make contact can be used and the changeover contacts must be positively driven. Therefore, only relays with at least two changeover contacts can be used in safety-related circuits.

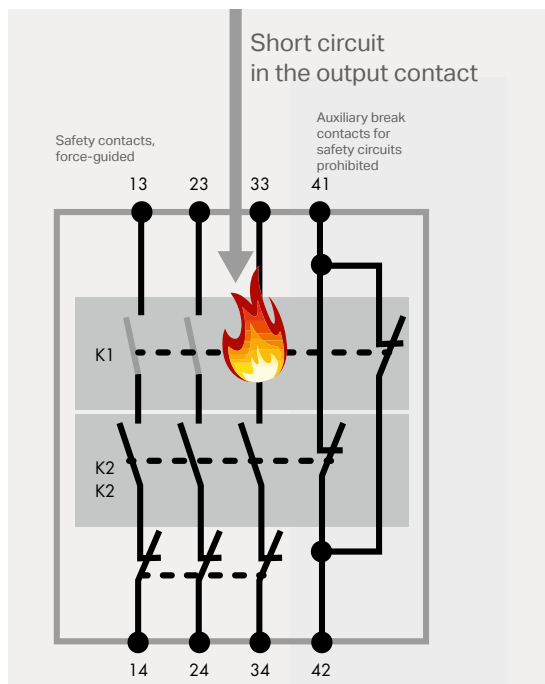



@th-photo/Fotolia.com

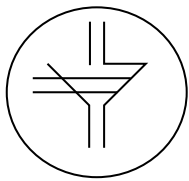

Type A

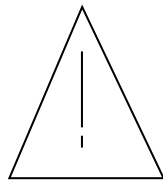

Type B

The EN 50205 standard differentiates between two contact sets by the type of positively driven operation:

Type A: Relay in which all the contacts are mechanically connect

Type B: Relays that have both mechanically connected and non-mechanically connected contacts

Relay Selection for Safety Relays

	Description	Item No.	Nominal Input Voltage V_N	Limiting Continuous Current
	<p>Safety relay module SR2M (2 changeover contacts) with force-guided contacts (type A) and status indication</p>	788-384	24 VDC	6 A
	<p>Safety relay module SR2M (2 changeover contacts) with force-guided gold contacts (type A) and status indication</p>	788-906	24 VDC	0,3 A
	<p>Safety relay module with 4 break contacts and 4 make contacts, relay pre-soldered onto carrier, force-guided contacts, type B</p>	288-414	24 V AC/DC	6 A

THE CONTACT MATERIAL IS CRUCIAL

Small Circuit Loads/Harsh Environment

Standard relay contacts are normally made of silver alloys such as silver nickel, silver tin oxide or silver cadmium. They are well suited for use in a variety of applications. However, they are limited to small loads, currents and voltages. The surfaces of the silver alloys are prone to oxidation, which leads to an increase in contact resistance. It is not a problem when switching larger loads because ever smaller cleaning electric arcs result. That is not the case for smaller loads.

There is not enough energy to break up and clean the oxide layer thermally. This results in malfunctions that can be prevented using hard, gold-plated contacts. Gold does not form an oxide layer and is also very resistant against corrosion in adverse conditions.

WAGO has added a relay version with hard, gold plating to the relay portfolio for switching small loads. They are intended for such applications and guarantee reliable signal transmission over a long period.

Prevent malfunctions: Relays with hard, gold-plated contacts are particularly well suited for switching small loads.

©Stitched Panorama/Fotolia.com



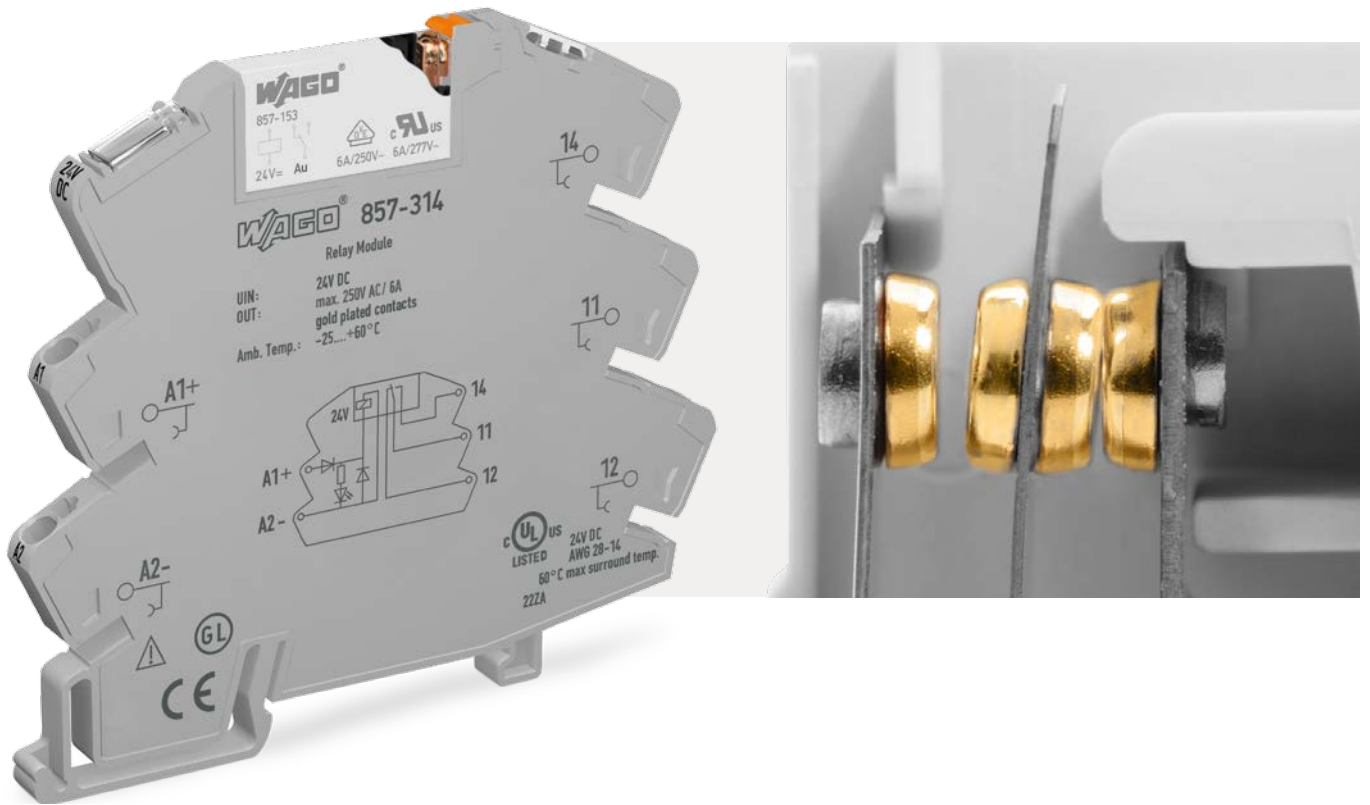

Contact Material	Application Area
AgNi – silver-nickel contact	Resistance loads Weak inductive loads For normal or higher power
AgSnO₂ – silver tin oxide contact	For high switching loads, primarily in supply voltage applications with high inrush currents Very low tendency to fuse, good burn-off resistance Low material material migration when switching from DC
AgCdO– silver cadmium contact	Inductive AC loads For high switching loads, primarily in supply voltage applications Low tendency to fuse, good burn-off resistance
AgNi + Au – silver-nickel contact with hard gold plating	Small load range Very corrosion resistant; important material for reliable contact at low switching capacities



In chemical plants, sewage plants or in steel production, aggressive gases always have to be taken into account: Relays with gold contacts protect against oxidation and corrosion.

©tuastockphoto/Fotolia.com

THE CONTACT MATERIAL IS CRUCIAL

Small Circuit Loads/Harsh Environment







In some sectors of industry, like chemical plants and steelworks, as well as in sewage plants, aggressive gasses are common. Higher pollution levels, as well as high humidity and high temperatures negatively impact electrical components. Relay modules with contacts made of silver alloys are not the first choice. The contact surfaces oxidize preventing switching operations from applying enough energy to reliably break up the oxide layer thermally. Malfunctions then result.

How can malfunctions be prevented?

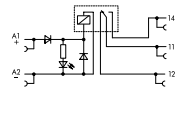
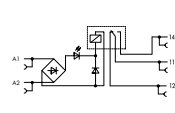
Like switching smaller loads, hard, gold-plated contacts excel in these applications. Relays equipped with gold-plated contacts operate reliably in small load applications up to 50 mA and 30 V. For these jobs, WAGO has developed a relay model that guarantees reliable operation.

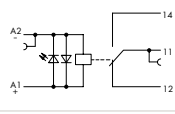
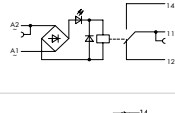

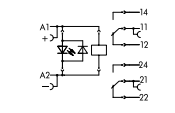
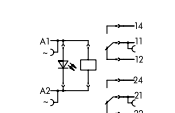
Relay Selection with Gold Contacts

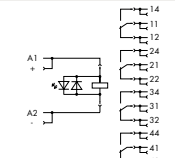
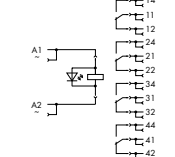
		Description	Item No.	Nominal Input Voltage V_{IN}	Limiting Continuous Current
		Relay module with 1 changeover contact, with gold contacts, for normal switching	857-314	24 VDC	6 A*
			857-368	230 VAC/DC	
		Relay module with 1 changeover contact, with gold contacts, for normal switching	859-314	24 VDC	5 A*
			859-359	230 VAC	
		Relay module with 2 changeover contacts, with gold contacts and status indication	788-412	24 VDC	8 A*
			788-616	230 VAC	
		Industrial relay module, 4 changeover contacts with gold contacts	858-314	24 VDC	5 A*
			858-518	230 VAC	

*To prevent the gold layer from being damaged, 30 VDC switching voltages and 50 mA currents shall not be exceeded. Higher switching power eventually evaporates the gold layer. The resulting deposits in the housing may reduce the service life.

RELAYS WITH MANUAL OPERATION

Switch Manually and Electrically

To switch individual circuits specifically without actuating the controller has a number of tangible advantages in a number of applications, e.g., at start-up. For complex building control systems, individual building systems can be checked and commissioned independently of the controller setup. The same applies to commissioning in industrial processes. When troubleshooting, or to ensure limited manual operation, service and maintenance personnel appreciate the option of manual operation.

Mechanical or Electrical Manual Operation

WAGO offers two alternatives for the relay modules with manual operation. Version one is designed for front panel manual operation, i.e., the contacts are only closed manually. In manual operation, the modules are limited to approximately 100 switching operations. In automatic mode, these modules complete the usual switching operations of the relay.

With the second version with manual operation, the relay coil is electrically connected. The operating status can be set via a Manual/OFF/Auto switch on the front panel. The relay modules complete the usual switching operations of the relay without limitation.

Application example,
building automation

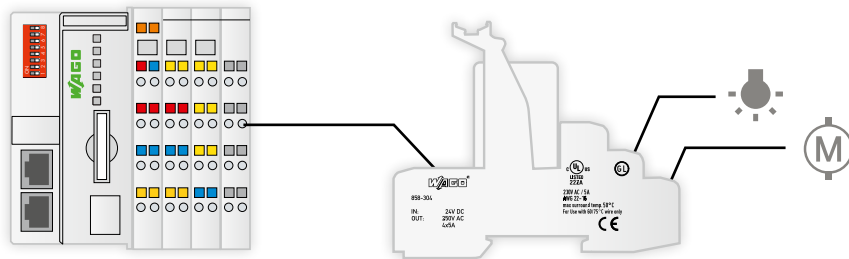





Extremely practical in building automation and process control:
Increased system uptime in the event of a controller failure
thanks to a relay with manual operation.

@leungchopan/Fotolia.com

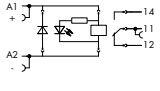
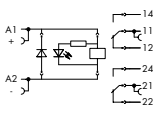

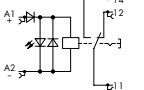
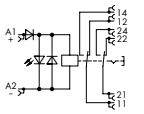
Relay Selection with Manual Operation

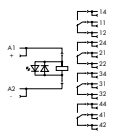
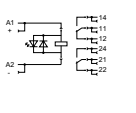
	Description	Item No.	Nominal Input Voltage V_N	Limiting Continuous Current
	 <p>Relay module with 1 changeover contact, electrical and mechanical status indication, manual operation</p>	788-341	24 VDC	16 A
	 <p>Relay module with 2 changeover contacts, electrical and mechanical status indication, manual operation</p>	788-346		
	 <p>Relay module with 1 changeover contact, manual operation for manual start-up, electrical and mechanical status indication</p>	789-1341	24 VDC	12 A
	 <p>Relay module with 2 changeover contact, manual operation for manual start-up, electrical and mechanical status indication</p>	789-1346		
	 <p>Industrial relay module, 4 changeover contacts, manual operation for manual start-up, electrical and mechanical status indication</p>	858-304	24 VDC	5 A
	 <p>Industrial relay module, 2 changeover contacts, manual operation for manual start-up, electrical and mechanical status indication</p>	858-324		

Relay Selection with Manual/OFF/Auto Switch

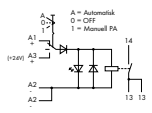
	Description	Item No.	Nominal Input Voltage V_N	Limiting Continuous Current
	 <p>Lamp load relay module with 1 make contact, Manual/OFF/Auto switch</p>	789-323	24 VDC	16 A
	 <p>Lamp load relay module with 1 make contact, Manual/OFF/Auto switch with feedback contact</p>	789-325		

RELAYS WITH A WIDE INPUT VOLTAGE RANGE

Versatile

In principle, the relay modules with a wide input voltage range are well-rounded, making them perfect for virtually any application. Like the WAGO standard relay modules, they comply with all relevant standards and regulations. These relay modules are designed for DC and AC voltages from 24 V to 230 V, can connect limiting continuous currents up to 6 A and have the same number of switching cycles as the standard versions.

They are recommended for a number of applications, e.g., service and maintenance. Technicians and maintenance specialists need only one relay module for all voltages that is immediately accessible in the case of error to replace a defective module. A comprehensive inventory of relay modules for various voltage ranges is no longer necessary. The "One module for all applications" principle also optimizes production and storage for manufacturers with small production runs that are exported internationally. They need only one relay module as the world standard. For ease of use and reliable electrical connections, WAGO equips the relay modules with push-in CAGE CLAMP® connection technology.

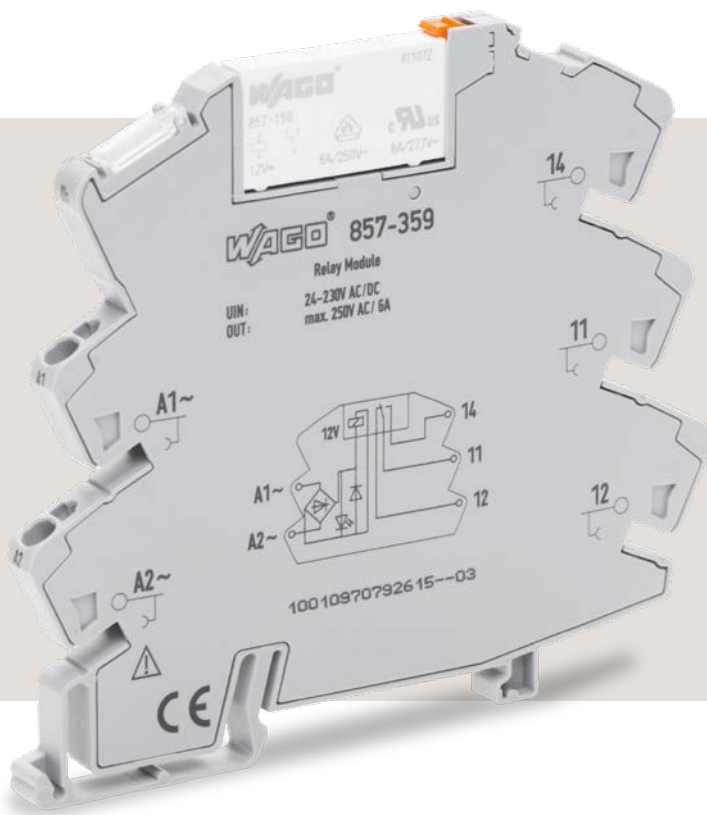

Storage and maintenance costs can also be significantly reduced because one single module covers nearly all standard voltage ranges.

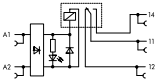

©industrieblick/Fotolia.com

		Description	Item No.	Nominal Input Voltage V_N	Limiting Continuous Current
		Relay module with 1 changeover contact, for normal switching	857-359	24 V ... 230 V AC/DC	6 A
		Relay module with 1 changeover contact, with gold contacts, for normal switching	857-369	24 V ... 230 V AC/DC	6 A*

*To prevent the gold layer from being damaged, 30 VDC switching voltages and 50 mA currents shall not be exceeded. Higher switching power eventually evaporates the gold layer. The resulting deposits in the housing may reduce the service life.

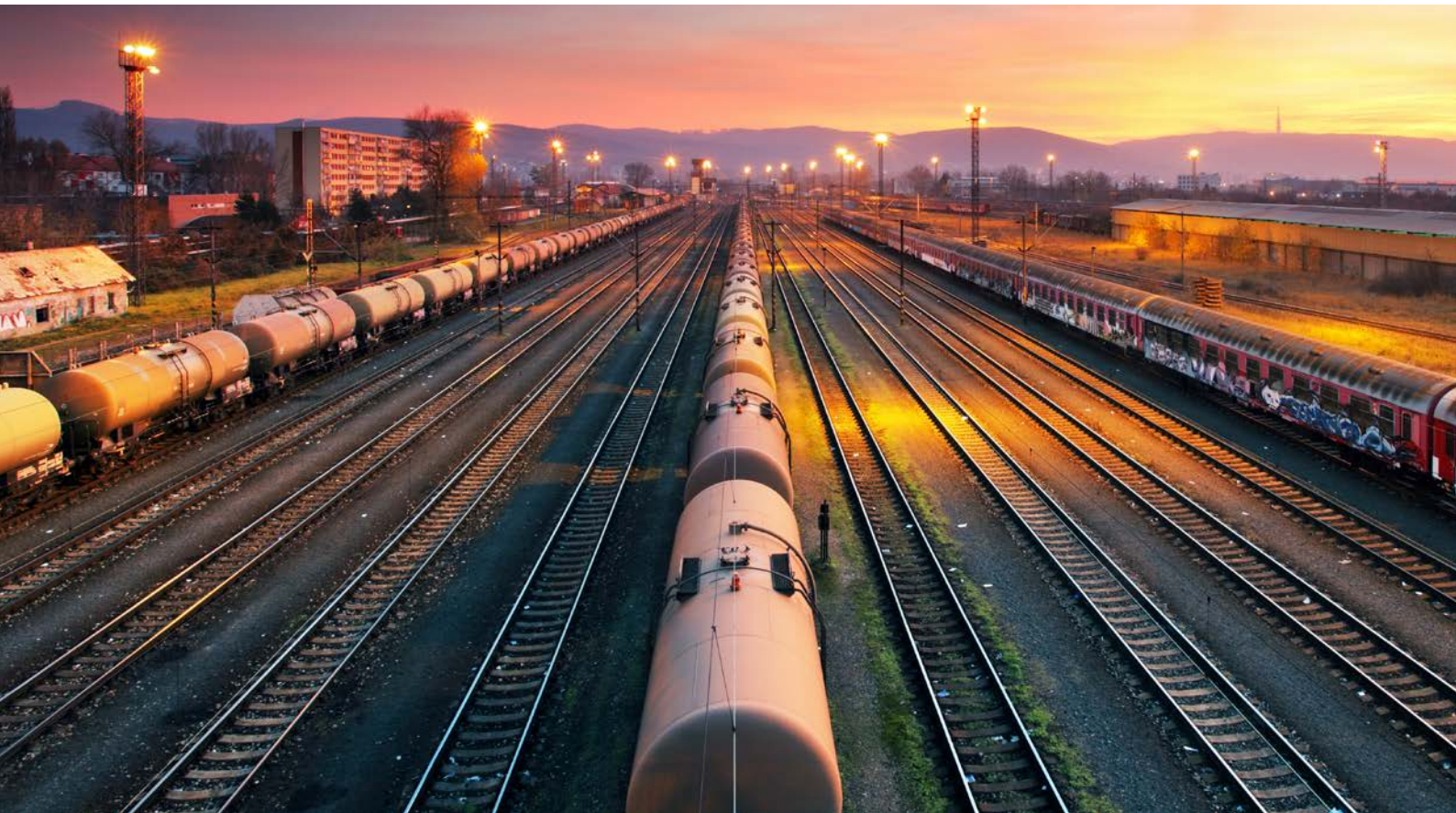

Within railway applications, there are special requirements for relays including operating voltage, ambient temperature and shock/vibration resistance: Relays from WAGO meet these requirements.

©TTStudio/Fotolia.com

RAIL-SPECIFIC REQUIREMENTS



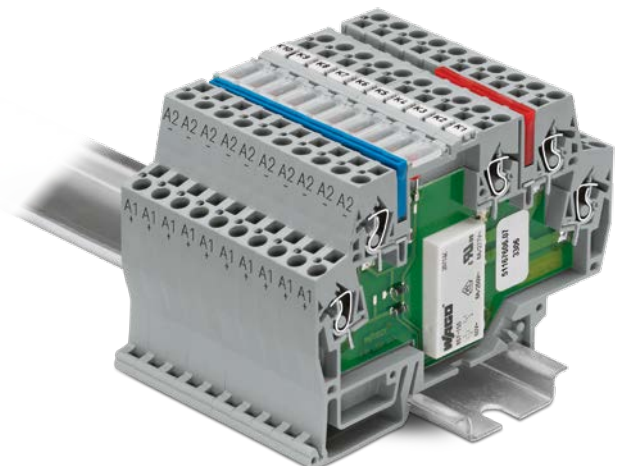

Master Voltage Fluctuations

Railway systems have two fundamental areas of application: There are the fixed installations in signal boxes, turnout systems and access systems on the one hand. On the other, there are installations in rail vehicles. Of central importance in this area is EN 50155, which differs significantly from traditional industrial standards. All components used in railway applications must operate reliably at voltages between 70 % and 125 % of the nominal voltage.

Brief spikes up to 1.4 times the nominal voltage may not cause any damage. Deviations from these rules only apply to components powered by stabilized voltage supplies. Fluctuations of $\pm 10\%$ of the nominal voltage are permitted – values common for industrial applications.

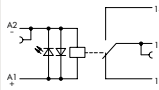
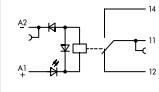

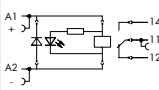
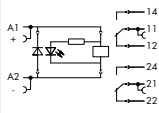
Relay Options for Railway Systems

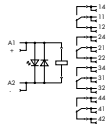
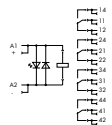
	Description	Item No.	Nominal Input Voltage V_N	Limiting Continuous Current
	 <p>Relay module with 1 changeover contact, with input voltage range of -30 ... +25 %</p>	859-390	24 VDC	3 A
	 <p>Relay module with 1 changeover contact, with input voltage range of -40 ... +40 %</p>	859-398	24 VDC	3 A
	 <p>Relay module with 1 changeover contact, with gold contacts, with input voltage range of -30 ... +25 %</p>	859-392	24 VDC	3 A*
	 <p>Relay module with 1 changeover contact, manual operation and extended input voltage/temperature range</p>	788-391	24 VDC	3 A
	 <p>Relay module with 2 changeover contacts, manual operation and extended input voltage/temperature range</p>	788-390	24 VDC	3 A
	 <p>Relay module with 4 changeover contacts and extended input voltage/temperature range</p>	858-354	24 VDC	5 A
	 <p>Relay module with 4 changeover contacts and extended input voltage/temperature range, with gold contacts</p>	858-355	24 VDC	5 A*

*To prevent the gold layer from being damaged, 30 VDC switching voltages and 50 mA currents shall not be exceeded. Higher switching power eventually evaporates the gold layer. The resulting deposits in the housing may reduce the service life.

Optocoupler Options for Railway Systems





	Description	Item No.	Nominal Input Voltage V_N	Limiting Continuous Current
	 <p>Optocoupler module with extended input voltage and temperature range, for railway applications</p>	859-798	12 VDC	100 mA
	 <p>Optocoupler module with extended input voltage and temperature range, for railway applications</p>	859-794	24 VDC	100 mA
	 <p>Optocoupler module with extended input voltage and temperature range, for railway applications</p>	859-795	5 VDC	100 mA

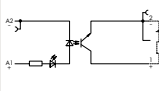

Photo: vossloh

RAIL-SPECIFIC REQUIREMENTS

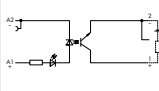
Ambient Operating Temperature and Mechanical Influences

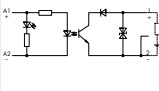
Components such as relay modules are exposed to extreme temperatures of -40 °C to $+70\text{ °C}$ in railway applications depending on the area of application. This is because the control cabinet is sometimes installed in steel housings below the passenger compartment that are not climate controlled. In principle, depending on the place of installation and heat ratio, the railway divides the areas of application for electrical components into four temperature classes, from T1 to TX.

Experience has shown that a number of applications fall in class T3, which corresponds to the temperature range of -25 °C to $+70\text{ °C}$. All WAGO relay modules for railway applications correspond to the highest classes of T3 or TX.

Loads due to vibration and shock are also significant in railway vehicles. EN 61373 "Railway applications – Rolling stock equipment – Shock and vibration tests" describes the mechanical influences in detail caused by operation.

The WAGO relay modules meet all requirements for use in railway operations in categories 1A to 1B. Due to the spring-loaded connection, they also offer high shock and vibration resistance.

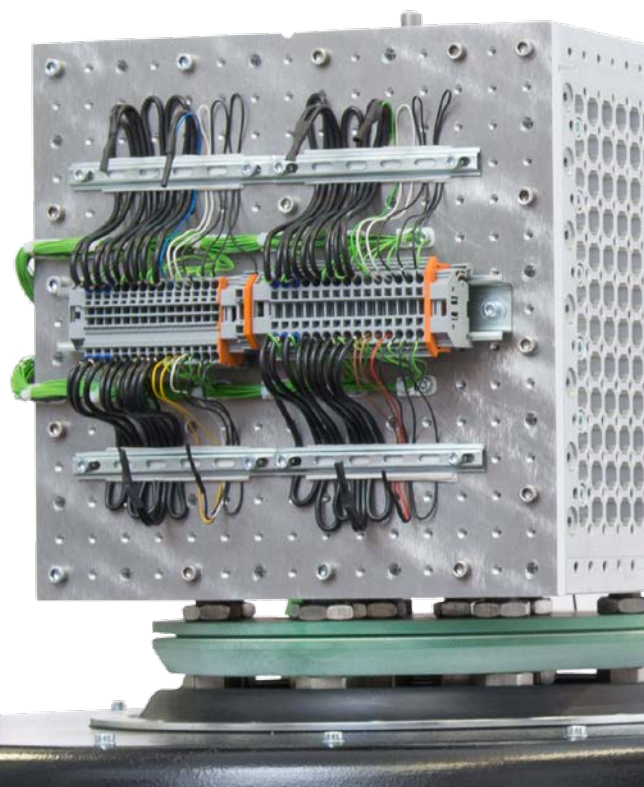

Test set-up for mechanical influences during operation

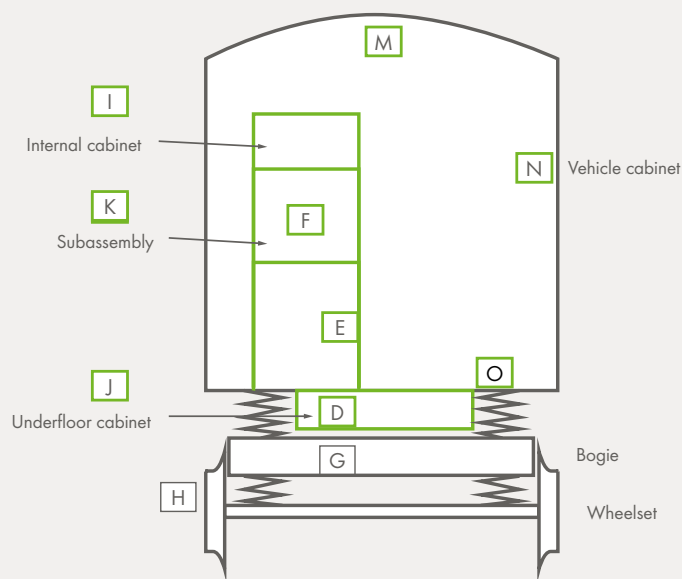

Vibration and Shock: Classification per EN 61373

Category	Location	Description of Device Location
1 Class A	M N O I and J	Components attached directly to or in the vehicle
1 Class B	D	Components installed in a under floor cabinet which in turn is attached to the vehicle body
1 Class B	K and E	Components installed in a large internal cabinet which in turn is attached to the vehicle body
1 Class B	F	Components as elements of subassemblies installed in a cabinet which in turn is attached to the vehicle body
2	G	Cabinets, subassemblies, devices and components attached to the bogie of a railway vehicle
3	H	Cabinets, devices and components or assemblies attached to the wheelset of a railway vehicle

Ambient Operating Temperature per EN 50155

	External Vehicle Ambient Temperature	Internal Cabinet Temperature	Internal Cabinet Overtemperature (< 10 min)	Air Temperature on the PCB
T1	-25 ... +40 C°	-25 ... +55 C°	+15 K	-25 ... +70 C°
T2	-40 ... +35 C°	-40 ... +55 C°	+15 K	-40 ... +70 C°
T3	-25 ... +45 C°	-25 ... +70 C°	+15 K	-25 ... +85 C°
TX	-40 ... +50 C°	-40 ... +70 C°	+15 K	-40 ... +85 C°



DC load limit curve
788-312

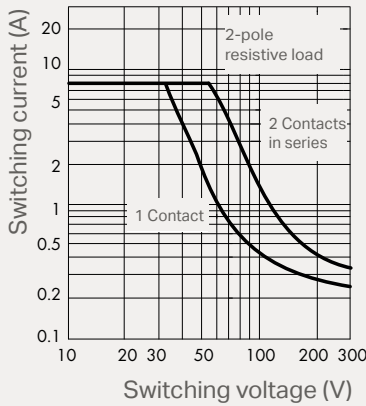

DC load limit curve
858-391

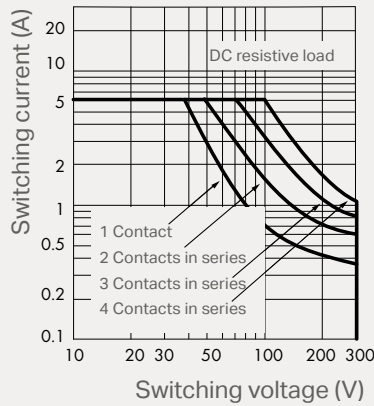

DC load limit curve
858-304, -308

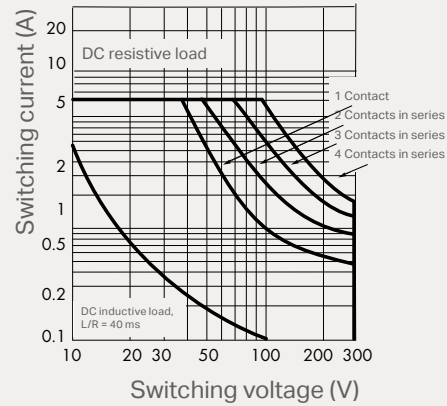

SWITCHING DC LOADS

Contacts Connected in Series Improve Load Limit Curve

Applications in DC relays are limited to selected areas, which are often battery-backed to increase availability. Such applications include controller instrumentation and control in power plants, chemical systems or railway systems. Safely switching DC loads requires sophisticated technology. Unlike AC loads, the switching arc is not extinguished automatically with the zero voltage. For DC loads, the arc length is largely dependent on the voltages and currents to be switched as the static electric arc limit curve shows. The more pronounced the electric arc, the shorter the service life of the relay. If the limit curve is exceeded, the electric arc is no longer extinguished and the relay is destroyed.

Structurally, the service life can be achieved by increasing the contact distance. However, clear limits are set here by the relay design.

An albeit significantly weakened effect can be achieved with "series-connected contacts" as the DC load curves show. Because the contacts are slightly offset in time, the double values are not achieved like for a single contact with double distances.

Static electric arc limit curve

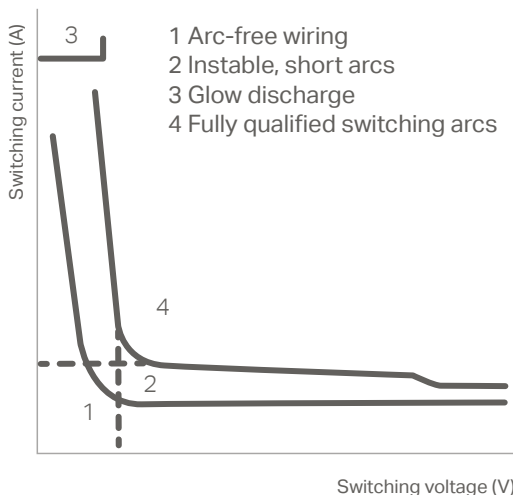





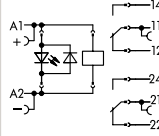

High DC voltages in battery-backed process control systems:
Relay with contacts connected in series control arcs.

©panthermedia.net/Leung Cho Pan

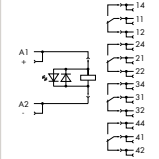
Relay Selection for DC Loads

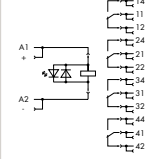
		Description	Item No.	Nominal Input Voltage V_N	Limiting Continuous Current
		Relay module with 2 changeover contacts and status indication	788-312	24 VDC	8 A
		Industrial relay module, 4 changeover contacts	858-304	24 VDC	5 A
			858-308	220 VDC	
		Industrial relay module, 4 changeover contacts	858-391	220 VDC	6 A

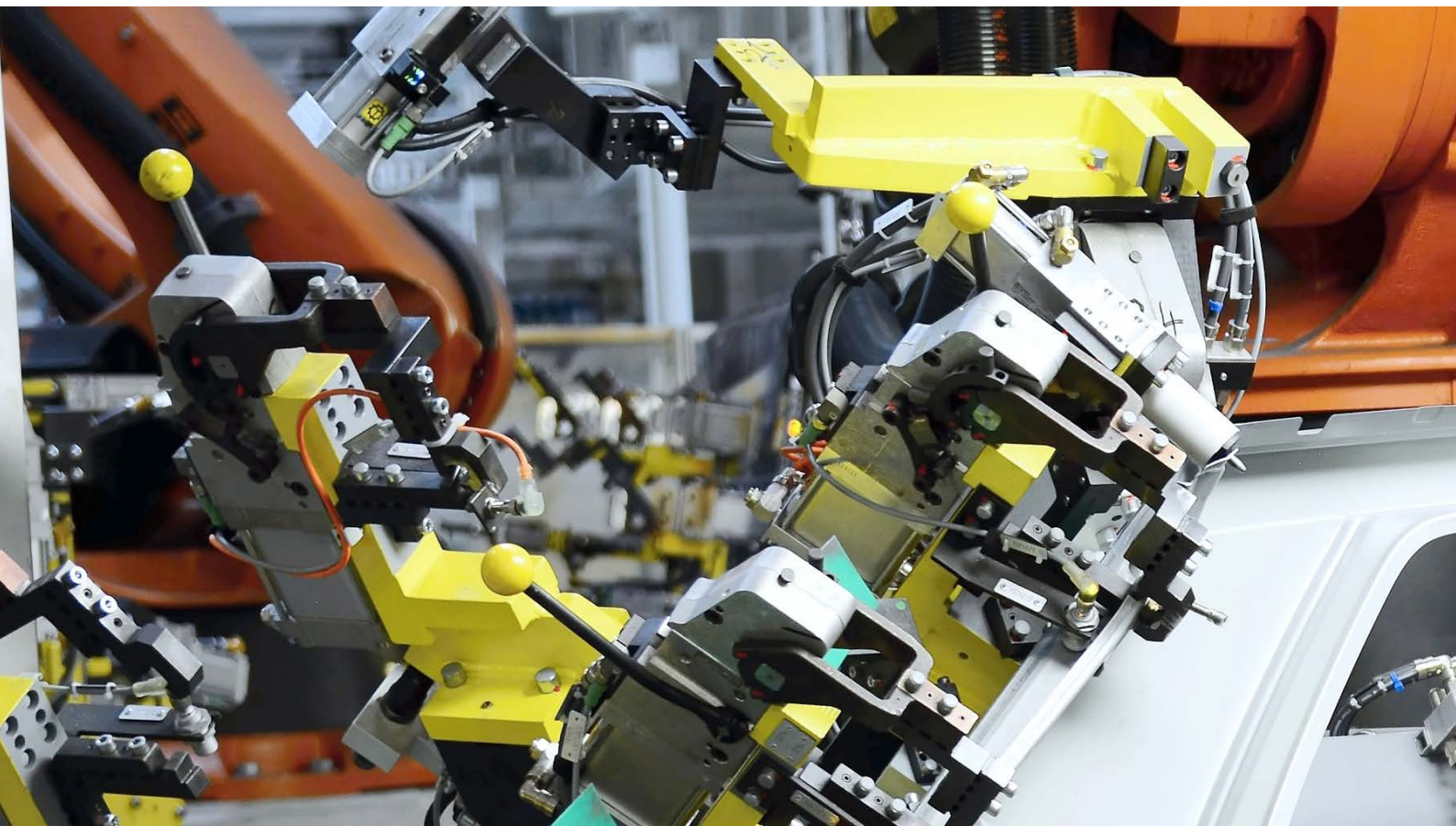

Ideal for production lines: Optocouplers distinguish themselves with long service lives and short clearing times.

OPTOCOUPERS AND SOLID-STATE RELAYS

Durable and Wear-Free

WAGO has developed a wide range of optocoupler and SSR modules for industrial applications. The optocouplers are directly integrated into the housing for all WAGO optocoupler modules. SSR modules are interchangeable solid-state relays that are PIN compatible with all standard relays. There is an extensive portfolio with versions for both DC and AC voltages. They are designed for nominal voltage ranges in the input of 5 V to 230 V and in the output between 3 V and 280 V. The integrated protective circuit ensures sound operation in all applications. The modules switch loads with inrush and switch-off currents equally. These include incandescent bulbs with resistive and ECG with capacitive load to the originators of high inrush currents, magnet valves with their inductive coils to the originators of burdening switch-off currents.

For areas of application with high switching peaks, WAGO has developed optocouplers and solid-state relays with zero voltage switch. These minimize peaks.

As an interface module between process peripherals, as well as control and signaling equipment, optocouplers and solid-state relays (SSR) impress with the following advantages:

- Long service life
- No mechanical wear
- No contact bouncing
- Short clearing times
- Low inrush current
- Silent
- Shock- and vibration-resistance



©Hamik/Fotolia.com

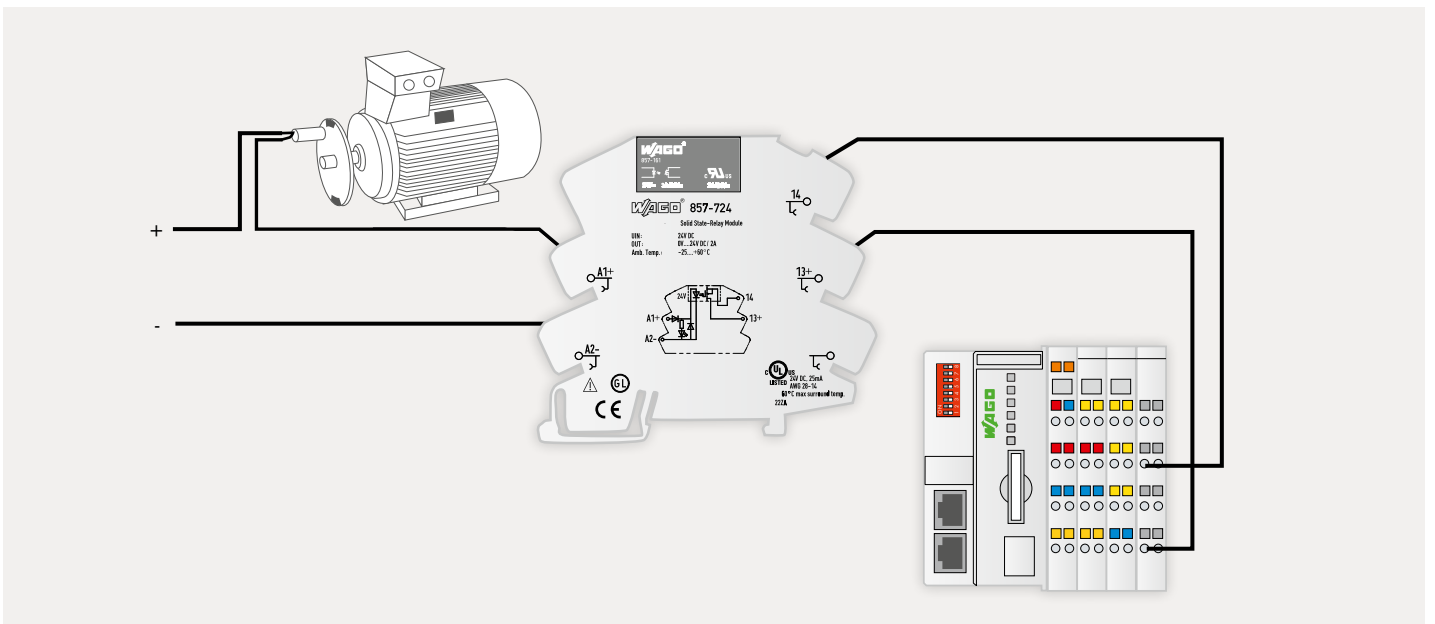

Application example: Galvanic isolation, e.g., rev counter

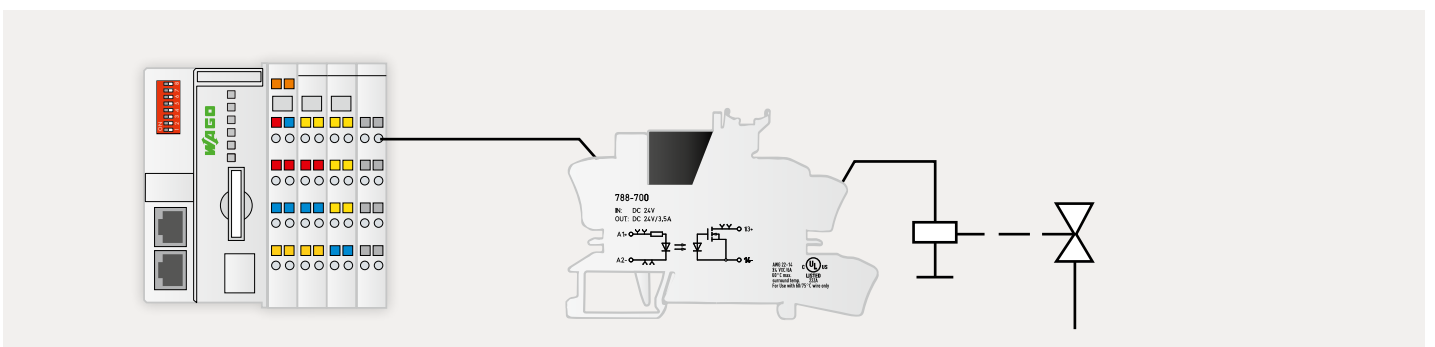







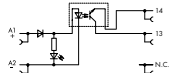

Application example: Signal amplification, e.g., compressed-air valve

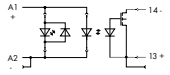
OPTOCOUPLEDERS AND SOLID-STATE RELAYS

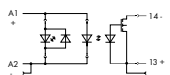
Durable and Wear-Free

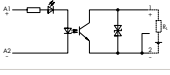

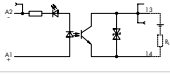

Selection for DC Load, 2-Wire Connection

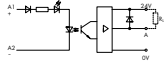
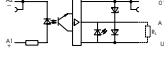
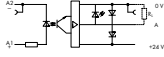
	Description	Item No.	Nominal Input Voltage V_N	Output Voltage Range	Limiting Continuous Current
	 <p>Solid-state relay module</p>	857-704	24 VDC	0 ... 48 VDC	0.1 ADC
		857-724	24 VDC	0 ... 24 VDC	3 ADC
	 <p>Solid-state relay module</p>	788-700	24 VDC	0 ... 24 VDC	3.5 ADC
	 <p>Solid-state relay module</p>	788-701	24 VDC	0 ... 30 VDC	5 ADC
	 <p>Optocoupler module</p>	859-796	24 VDC	3 ... 30 VDC	100 mA
		859-795	5 VDC	3 ... 30 VDC	100 mA
	 <p>Power optocoupler module</p>	859-761	24 VDC	3 ... 30 VDC	3 A
		859-762	24 VDC	3 ... 30 VDC	3 A
		859-744	48 VDC	3 ... 53 VDC	4 A

Selection for DC Load, 3-Wire Connection

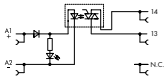
	Description	Item No.	Nominal Input Voltage V_N	Output Voltage Range	Limiting Continuous Current	
		Power optocoupler module, negative switching	859-720	24 VDC	10 ... 30 VDC	3 A
		Optocoupler module, negative switching	859-702	24 VDC	20 ... 30 VDC	500 mA
		859-708	24 VDC	20 ... 30 VDC	500 mA	
		859-706	24 VDC	4 ... 6.25 VDC	500 mA	
		Optocoupler module, positive switching	859-752	5 VDC	20 ... 30 VDC	500 mA
		859-758	24 VDC	20 ... 30 VDC	500 mA	
		859-756	24 VDC	4 ... 6.25 VDC	500 mA	

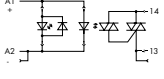
Selection for AC Load

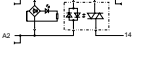
	Description	Item No.	Nominal Input Voltage V_N	Output Voltage Range	Limiting Continuous Current	
		Solid-state relay module	857-714	24 VDC	24 ... 240 VAC	2 A AC
		Solid-state relay module	788-720	24 VDC	24 ... 240 VAC	1 A AC
		Solid-state relay module	788-721	24 V AC/DC	12 ... 275 VAC	4 A AC

GLOSSARY

Respond

Change in the switching position of a relay from the idle state (e.g., make contacts open) to the working state (e.g., make contacts closed) caused by applying the power; this process was formerly called "tightening."

Bistable relay

Electrical relay that remains in the achieved switching state after switching off the power; to return to the initial state, another suitable state (e.g., triggering the reset coil) is necessary.

Inrush current

The indication of the maximum inrush current specifies which peak current is allowed when switching on a contact under defined conditions (e.g., voltage, power factor, time response) without the relay then malfunctioning. The inrush current can often be much higher.

Electrical service life

Number of switching cycles until the relay fails under a specified electrical load and defined operating conditions; the standard service life values usually apply to the maximum permissible resistive load. For smaller switching loads, a much longer service life is expected. For larger switching loads, the service life is greatly reduced.

Electrical relay

Component that generates sudden predetermined changes to one or more output criteria when certain requirements in the excitation circuit (input circuit) are met.

Electromechanical relay

Electrical relay in which the electrical current effects mechanical movements in the excitation circuit that execute the operation in the output circuit.

Freewheel diodes

Recovery diodes are primarily used to protect against overvoltages that arise when switching off an inductive DC load (electric motor, relay coil) by self-induction. Voltage peaks are limited to the value of the diode forward voltage and overruns diverted via the diode. However, this leads to a delay in the voltage drop and switching operation.

Electrical isolation

Potential-free isolation between electrical parts; with galvanic isolation, no charge carriers flow from one circuit to another, i.e., there is no electrically conductive connection between circuits. However, the circuits can still exchange electrical power or signals and specifically via magnetic fields, by means of infrared radiation or charge displacement.

Solid-state relay

Solid-state relay with a switching element that is an electronic component, e.g., transistor, thyristor or triac; solid-state resistors that boast wear-free operation; compared to relays, they have a high switching frequency. Galvanic isolation is achieved by an integrated optocoupler.

Contact type

The three most important contact types (also called the contact spring set) are make contact, closed contact and changeover contact.

They are abbreviated as follows:

Germany	UK	America
Make contact 1	make A	SPST-NO (normally open)
Break contact 2	break B	SPST-NC (normally closed)
Changeover contact 21	changeover C	SPDT

Creepage distance

Shortest distance between two conductive parts measured along the surface of an insulating material.

Short-circuit-protected

Switching off the final stage of a solid-state relay to protect the output circuit against destruction in the event of a short circuit.

Load category (solid-state relay) Load classification for solid-state relays according to EN 62314

LC A – Resistive loads or low inductive loads

LC B – Motor loads

LC C – Electrical discharge lamps

LC D – Incandescent lamps

LC E – Transformers

LC F – Capacitive loads

Leakage current

Current on the load side of an optocoupler that flows in the locked state of the output stage. Clearance Shortest air space between two conductive parts.

Mechanical service life

Number of switching cycles during which the relay remains functional with current-free switching contacts.

Monostable relay

Electrical relay that returns to its initial state after switching off the energizing quantity.

Normally closed contact

The contact is closed when the relay is in the idle state and open when the relay is in the working state.

Optocoupler

Optocouplers are electronic components with which a load current is switched via a control circuit. Unlike electromechanical relays, optocouplers have no mechanical parts prone to wear. In the control circuit, a light signal is triggered for the switching operation via an LED that in a photosensitive semiconductor receiver causes the closure of an applied load circuit. Sender (LED) and receiver (e.g., phototransistor) are embedded in a light-conductive plastic and surrounded by an opaque envelope that protects against external influences.

Bounce time

Time from the first to the final closure (or opening) of a contact caused by shock processes of the contact movement; these shock processes are called "contact bouncing."

Release time

Time between switching off the coil excitation and the first opening of the make contact or first closing of the break contact.

Switching inductive load

For inductive loads mainly present when using coils in the load circuit, the problem arises when switching off. A magnetic field forms from the current flow in the coil that suddenly collapses and generates a high induction voltage. This voltage peak must be short circuited by a diode connected in parallel. However, the time needed leads to a fall delay.

GLOSSARY

Switching capacitive load

Capacity loads occur when there is capacitor in the load circuit. This acts like a short circuit when switching on and causes a high inrush current. If the current is not limited, it can destroy the semiconductor.

Switching resistive load

Because the amperage in the load circuit and the voltage via the semiconductor behave inversely proportional to each other for resistive loads, there is usually no problem. Maintaining the maximum amperage and voltage levels of the components is sufficient here. There is a special case when switching incandescent bulbs. Due to the low cold resistance, overcurrents at 10 to 20 times the operating current can arise when switching on. The components must be designed for these potential overloads that correspond to the effect with capacitive load.

Switching cycle

The response and relapse of a relay as a result of switching on and off the power.

Make contact

The contact is closed when the relay is in the working state and open when the relay is in the idle state.

Switching current

Current (AC or DC) that can switch a relay contact on and off. Degree of protection, categories for elementary relays according to IEC 61810:

RT 0: Unenclosed relay

Relay not provided with a protective housing.

RT I: Dust-protected relay

Relay provided with a housing that protects its mechanisms from dust.

RT II: Flux-proof relay

Relay capable of being automatically soldered without allowing the migration of solder fluxes beyond the intended areas.

RT III: Wash tight (washable) relay

Relay capable of being automatically soldered and subsequently undergoing a washing process to remove flux residues without allowing the ingress of flux or washing solvents.

RT IV: Sealed relay

Relay provided with a housing that has no vents to the outside atmosphere, and has a time constant better than $> 2 \times 10^4$ s (IEC60068-2-17).

RT V: Hermetically sealed relay

Sealed relay having an enhanced level of sealing, assuring a time constant better than $> 2 \times 10^6$ s (IEC60068-2-17).

Changeover contact

Compound contact consisting of break contact and make contact with a common terminal; if one of the contact circuits is open, the other is closed.

CONNECTION TECHNOLOGY

PUSH-IN CAGE CLAMP®

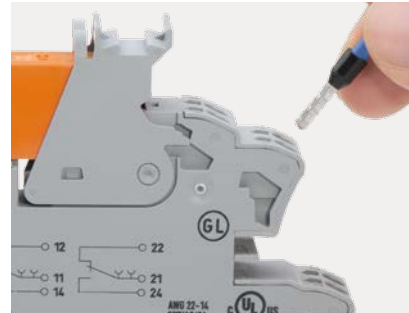
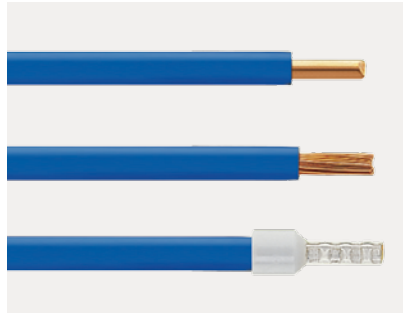

This connection technology is included in the following:



CAGE CLAMP®

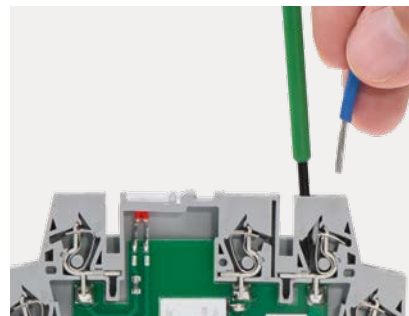
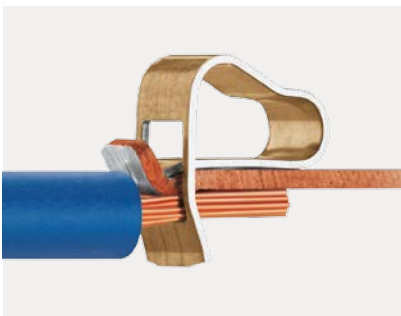

This connection technology is included in the following:



WAGO Kontakttechnik GmbH & Co. KG

Postfach 2880 · 32385 Minden
Hansastraße 27 · 32423 Minden
info@wago.com
www.wago.com

Headquarters	+49 571/ 887 - 0
Sales	+49 571/ 887 - 222
Order Service	+49 571/ 887 - 44333
Fax	+49 571/ 887 - 8 44169

WAGO is a registered trademark of WAGO Verwaltungsgesellschaft mbH.

"Copyright – WAGO Kontakttechnik GmbH & Co. KG – all rights reserved. The content and structure of the WAGO websites, catalogs, videos, and other WAGO media are subject to copyright. Distribution or modification to the contents of these pages and videos is prohibited. Furthermore, the content may neither be copied nor made available to third parties for commercial purposes. Also subject to copyright are the images and videos that were made available to WAGO Kontakttechnik GmbH & Co. KG by third parties."